

USER MANUAL WEIGHT INDICATOR

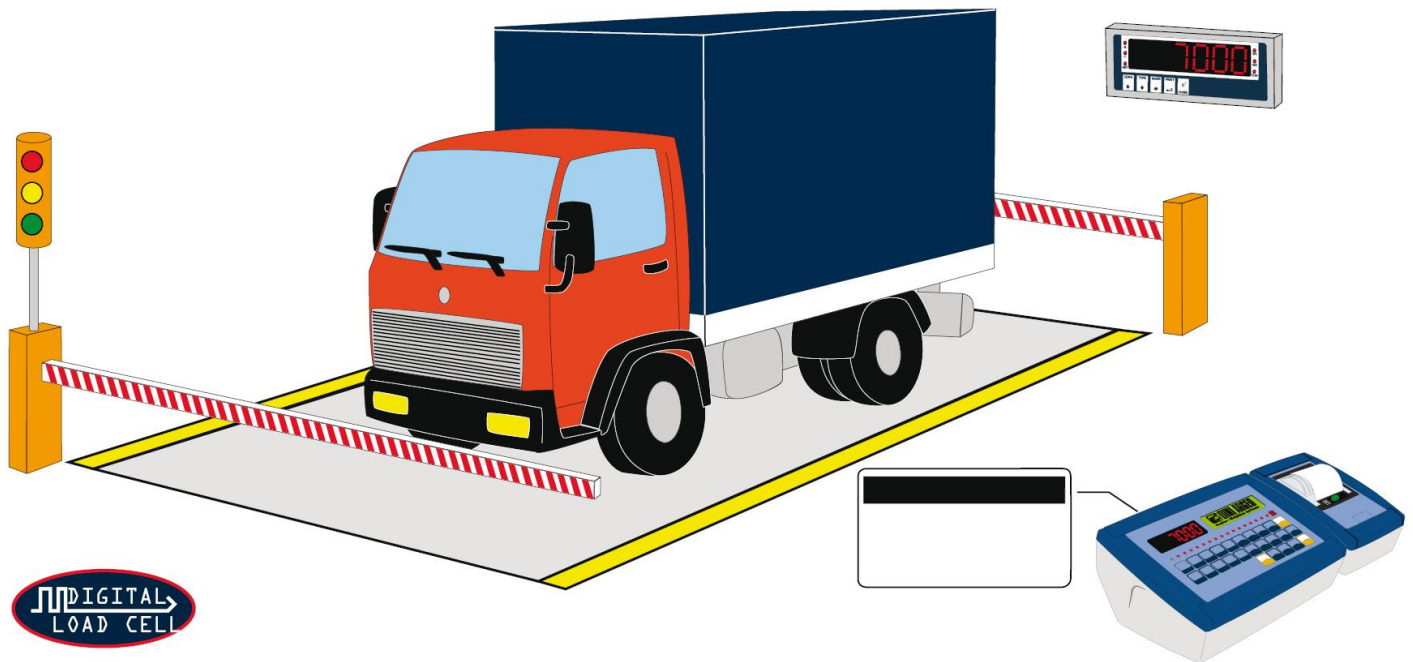

E-AF03: PROGRAM VERSION FOR VEHICLE WEIGHING SYSTEMS WITH INPUT/OUTPUT FUNCTION



3590EKR, 3590EXP, 3590EQXP, 3590EXT, 3590 EBOX,
CPWE, CPWET series indicator



INDEX

1. INTRODUCTION	5
2. MAIN TECHNICAL SPECIFICATIONS	6
2.1 ACCESSORIES AVAILABLE	7
2.2 SYMBOLS USED	7
3. INSTALLATION	8
3.1 CPWE DRILLING TEMPLATE, CASE AND DIMENSION	8
3.2 3590E CASE AND DIMENSIONS	9
3.3 CPWET CASE AND DIMENSIONS	11
3.4 CPWETF CASE AND DIMENSIONS	12
3.5 POWER SUPPLY	13
3.6 START UP	13
3.7 TURNING OFF THE INSTRUMENT	13
3.8 TURNING ON PRINTER IN ENERGY SAVING MODE	14
4. FRONT PANEL KEYS AND DISPLAYS	14
4.1 FUNCTION OF THE KEYS	15
4.1.1 "2ndF" KEY: SECOND FUNCTION OF THE KEYS	17
4.1.2 ENTERING ALPHANUMERIC TEXT	17
4.1.3 DISABLING THE KEYBOARD	18
4.1.4 HELP MENU	18
4.1.5 3590EQXP	19
4.1.5.1 "2ndF" KEY: SECOND FUNCTION OF THE KEYS 3590EQXP	21
4.1.6 INDICATOR CONNECTED TO PC KEYBOARD	22
4.1.7 REMOTE CONTROL	23
4.2 FUNCTION DISPLAY	25
4.2.1 WEIGHT ZOOM	25
4.2.2 STATUS INDICATORS	26
4.2.3 BATTERY LEVEL INDICATION	27
4.2.4 "TILT" DEVICE	27
4.2.5 DISPLAYED DATA	28
5. SELECTION OF THE SCALE	29
5.1 FUNCTIONING WITH REMOTE SCALE	30
5.2 "A+B" FUNCTION	30
5.3 WEIGHING WITH TWO SCALES: SELECTING INPUT/OUTPUT SCALES	31
6. SCALE ZERO FUNCTION	31
6.1 CYCLICAL AUTOMATIC ZERO	31
7. TARE FUNCTIONS	32
7.1 SEMIAUTOMATIC TARE	32
7.2 PRESET TARE	32
7.3 MANUAL CALCULATED TARE	32
7.4 TARE CANCELLATION	32
7.5 LOCKED/UNLOCKED TARE	33
7.6 LIMITATION OF THE TARE FUNCTIONS	33
7.7 TARE EXECUTION MODE OR DISABLING OF THE TARE	33
7.8 LINKING A PRESET TARE TO A VEHICLE IN THE DATABASE	33
8. MULTIRANGE AND MULTIDIVISION FUNCTION	33
9. DISPLAY OF METRIC DATA (inFO)	34
10. FILLING IN THE INPUT TEXT	34
10.1 QUICK MODIFICATION OF AN INPUT TEXT	34
11. DATABASE	35
11.1 CUSTOMERS	35
11.1.1 ENTRY	35
11.1.2 MODIFICATION	35
11.1.3 CANCELLATION	36
11.1.4 PRINTING	36

11.1.5 SELECTION / DESELECTION	36
11.1.6 ENTRY, MODIFICATION AND QUICK SELECTION OF CUSTOMER 000	37
11.1.7 ALPHABETICAL RESEARCH	37
11.1.8 HELP	37
11.2 MATERIALS	38
11.2.1 ENTRY	38
11.2.2 MODIFICATION	38
11.2.3 CANCELLATION	39
11.2.4 PRINTING	39
11.2.5 SELECTION / DESELECTION	39
11.2.6 ENTRY, MODIFICATION AND QUICK SELECTION OF MATERIAL 000	40
11.2.7 ALPHABETICAL RESEARCH	40
11.2.8 HELP	40
11.3 VEHICLES	41
11.3.1 ENTRY	41
11.3.2 MODIFICATION	41
11.3.3 CANCELLATION	42
11.3.4 PRINTING	42
11.3.5 SELECTION / DESELECTION	42
11.3.6 ENTRY, MODIFICATION AND QUICK SELECTION OF VEIHCLE 000	43
11.3.7 ALPHABETICAL RESEARCH	43
11.3.8 HELP	43
12. DATABASE ACCESS PASSWORD	44
13. WEIGHING PROCEDURES	44
13.1 GENERAL DESCRIPTION OF THE SYSTEM	44
13.2 WEIGHING THROUGH ID CODE	44
13.2.1 INPUT WEIGH	44
13.2.2 OUTPUT WEIGH	46
13.3 WEIGHING THROUGH VEHICLE LICENSE PLATE	47
13.3.1 INPUT WEIGH	47
13.3.2 OUTPUT WEIGHING	48
13.4 CONDITIONS FOR TOTALISATION	49
13.5 ADDITIONAL TARE FUNCTION	49
13.6 TOLERANCE WEIGHING FIELD	50
13.7 REENABLING THE PRINTING AND INPUT / OUTPUT WEIGH	50
13.8 VISUALISATION AND CLEARING OF THE ACCUMULATED TOTALS	50
13.9 PROGRESSIVES	51
13.9.1 PROGRESSIVE DIGITS	51
13.9.2 TICKET PROGRESSIVE	51
13.9.3 LOT PROGRESSIVE	51
14. SELF-SERVICE	52
14.1 SELF SERVICE SYSTEM	52
14.2 SELF SERVICE SYSTEM WITH BADGE READER OR RFID	52
14.3 SELF SERVICE SYSTEM WITH COIN	52
15. PRINTOUTS	53
15.1 LINKING OF THE FORMATS TO THE PRINT FUNCTIONS	55
15.1.1 QUICK LINKING OF THE FORMATS	56
15.2 NUMBER OF TICKET COPIES	56
15.3 REPETITION OF THE LAST EXECUTED PRINTOUT	56
15.4 STANDARD PRINTING FORMATS	56
16. OTHER FUNCTIONS	57
16.1 CALCULATOR	57
16.2 DISPLAY OF NET WEIGHT WITH SENSITIVITY X 10 (for testing use during calibration)	57
16.3 SETTING DATE / TIME	57
16.4 SET-POINT FUNCTION	57
16.4.1 NORMAL FUNCTIONING MODE	58

16.4.2 EXCLUSIVE FUNCTIONING MODE	61
16.4.3 QUICK MODIFICATION OF THE SETPOINTS	61
16.5 DIAGNOSTIC PERIPHERALS	61
16.6 COM DATA DIAGNOSTIC	62
17. ALIBI MEMORY	62
17.1 READING OF THE WEIGHS CARRIED OUT	62
17.2 ALIBI MEMORY CANCELLATION (only with non approved instrument)	63
18. MESSAGES	63
18.1 INSIDE THE SET-UP OR MENU OR AT START-UP	63
18.2 IN WEIGHING	64
DECLARATION OF CONFORMITY	66
WARRANTY	66

1. INTRODUCTION

This manual was created to help you install and learn all about the functional possibilities of the purchased indicator.

The instrument is suitable for use in various weighing environments.

Not only does it have all the normal features of high-precision scales, but it also gives you the possibility to work in specific environments due to the functioning modes contained in the software implemented in the FLASH MEMORY on the internal board; this makes the instrument extremely flexible and it can be used in many different industrial applications linked to weighing. The double numerical and interactive alphanumeric display, the alphanumeric and function keyboard, allow the operator an easy and immediate use and provide the microcontroller with DATA ENTRY functions in addition to the normal weighing functions. The input/output allows the instrument to control various external devices, to receive external commands, control a printer and communicate with a personal computer or to be inserted in a network of weight indicators controlled by a PC.



Please note that this instrument is covered by a warranty and **MUST NOT BE OPENED BY THE USER** for any reason whatsoever. Any attempt to repair or modify the unit exposes the user to the risk of electric shock and will invalidate the entire warranty.

If any problems are found in the unit or with the system in which it is used, the fact must be communicated to the manufacturer or the dealer from whom it was purchased.

In any case, **DISCONNECT THE POWER SUPPLY** before taking any action.

The version with the 6V rechargeable battery has to be completely recharged (12 hours) in the first installation of the instrument; we **RECOMMEND** disconnecting the battery if the instrument is not going to be used for more than 30 days. In order to avoid the deterioration of the rechargeable battery:

- In standard conditions, never leave the battery partially or completely uncharged; at least once a week recharge it completely .
- In case the instrument is not used for a long period, one needs to:
 1. completely recharge the battery before the system is switched off for the last time.
 2. recharge completely every 3 months

Do not pour liquids on the weight indicator.

Do not use solvents to clean the weight indicator.

Do not expose the instrument to direct sunlight nor place it near heat sources.

Place or anchor the weight indicator and platform on a non-vibrating base.

All the connections of the indicator have to be made respecting the rules applicable in the zone and in the installing environment.

Everything not expressly described in this manual has to be considered as improper use of the equipment.

Do not install in any area where there is a risk of explosion.

DO NOT exceed the rated capacity of the scale or of any load bearing element attached to the scale.

READ CAREFULLY AND APPLY WHAT IS DESCRIBED IN SECTION 3.



The crossed-out wheeled bin on the product means that at the product end of life, it must be taken to separate collection or to the reseller when a new equivalent type of equipment is purchased. The adequate differentiated refuse collection in having the product recycled, helps to avoid possible negative effects on the environment and health and supports the recycling of the materials of which the equipment is made. The unlawful disposal of the product by the user will entail fines foreseen by the current regulations.

2. MAIN TECHNICAL SPECIFICATIONS

POWER SUPPLY	<p>3590E:</p> <ul style="list-style-type: none"> - 12 Vdc (8 ÷ 24 Vdc in the IO versions), with internal 100 ÷ 240 Vac (50÷60 Hz) / 12 Vdc adapter. - 6 Vdc from rechargeable built-in battery, fitted depending on the model. <p>CPWE:</p> <ul style="list-style-type: none"> - 8 ÷ 24 Vdc - 6 Vdc from external rechargeable battery (upon request). <p>CPWET:</p> <ul style="list-style-type: none"> - 12 Vdc with external 100 ÷ 240 Vac (50÷60 Hz) / 12 Vdc adapter. - 6 Vdc from external rechargeable battery (upon request).
MAXIMUM POWER	16 VA.
OPERATING TEMPERATURE	From -15 to +40 °C (from 5 to 104 °F).
CONVERTER	24 bit Sigma Delta.
CONVERSION SPEED	200 conv./sec with automatic selection.
RANGE OF INPUT SIGNAL	0,6 mV/V - 3,2 mV/V.
MINIMUM VOLTAGE PER DIVISION	0.3 µV (approved instrument); 0.03 µV (non-approved instrument).
AUTOMATIC ZERO DETECTION	Only in gross mode, programmable at +/- ¼, ½, 1, 2 divisions.
ZERO RANGE	Configurable up to +/- 50% of max load capacity.
AUTO ZERO AT START-UP	Configurable up to +/- 50% of max load capacity.
LOAD CELL POWER SUPPLY	5Vdc ± 5%, 120mA (max 8 350-Ohm cells).
LOAD CELL CONNECTIONS	6 wires with Remote Sense.
DISPLAY DIVISIONS	10000e, 3 x 3000e for legal for trade weighing, expandable up to 800.000 for internal use (with minimum signal coming from the 1,6 mV/V cell).
DISPLAYS	<p>3590E:</p> <ul style="list-style-type: none"> - Red, high-luminosity LED indicators, with six digits (h 13 mm). - Back lit graphic 160x32 dot LCD. <p>CPWE: Back lit graphic 160x32 dot LCD.</p>
DATABASE/MEMORY	<p>Database of 500 customers (3 descriptions of 25 characters).</p> <p>Database of 500 materials (2 descriptions of 20 characters).</p> <p>Database of 500 vehicles (plate of 10 characters, description of 20 characters, linked tare).</p>
SIGNALS	<p>3590E: 16 status LEDs. Graphic icons on LCD display.</p> <p>CPWE: Graphic icons on LCD display.</p> <p>CPWET: 3-way control light. Graphic icons on LCD display</p>
KEYBOARD	Impermeable polycarbonate keyboard (IP65 protection degree), with membrane keys with audible and tactile feedback.
PARAMETER SETUP	Calibration and linearity (up to 8 points), fully digital and programmable from the keyboard or from PC with Dinitools™.
CLOCK/DATE	Fitted, with buffer RAM.
SERIAL OUTPUTS	<ul style="list-style-type: none"> - 2 input/output RS232 ports on terminal board/ amp connector. - 1 input/output RS485 port on terminal board or RS232 on amp connector.
INPUTS AND OUTPUTS	<ul style="list-style-type: none"> - Management of PC keyboard or barcode reader <p>3590EXP, 3590EXT and CPWET:</p> <ul style="list-style-type: none"> - 2 optoisolated inputs (optoisolated photo couplers), 12Vdc – 24Vdc, 20mA max - 4 outputs (optoisolated photomofets), 48Vac / 0.15A, 60Vdc / 0.15A, 10 Ω max. <p>3590EXT in IO version and CPWE:</p> <ul style="list-style-type: none"> - 8 inputs (optoisolated photo couplers), 12Vdc – 24Vdc, 20mA max. - 16 outputs (optoisolated photomofets), 48Vac / 0.15A, 60Vdc / 0.15A.
ANALOGUE OUTPUT (Option available on the 3590EXT "IO" version and CPWE version)	- 16-bit analogue output configurable from keyboard (full-scale value; zero scale value and minimum value) from 0 to 10 Vdc or from 0 to 20mA; the maximum resistance applicable on the output current is 350 Ohm and the minimum resistance applicable on the output voltage is 10 kohm.





2.1 ACCESSORIES AVAILABLE

On the indicator is possible implement internal and external modules used to increase interfacing possibilities.(For example, the number of usable outputs various types of printers, in order to have a report of the weighs made, or giant display in order to better see the weigh operations. Also, one can connect a PC in order to simply program the instrument through Dinitools™, or in order to have a complete management of the weighs.

Contact the reseller for the list of the available hardware and software accessories.

2.2 SYMBOLS USED

Below are the symbols or text used in the manual to recall the reader's attention or on the instrument to recall the user's attention.

	ATTENTION! Only qualified personnel must perform this operation
	ATTENTION! This is referred to working on energized lines: only qualified personnel must require or perform this operation.
	CE CONFORMITY
	IDENTIFIES THE CLASS OF PRECISION.
“TECH.MAN.REF.”	It means that an advanced function is being described (therefore for the technical personnel) which will be further explained in the corresponding technical manual.

THE INSTRUMENT'S DANGEROUS VOLTAGE PARTS AND THE PARTS THE USER CAN ACCESS HAVE BEEN ELECTRICALLY INSULATED.

3. INSTALLATION

3.1 CPWE DRILLING TEMPLATE, CASE AND DIMENSION

The weight indicator has an anodized aluminium case, whose external dimensions are shown in the figure. It should be mounted on a panel board respecting the safety norms.

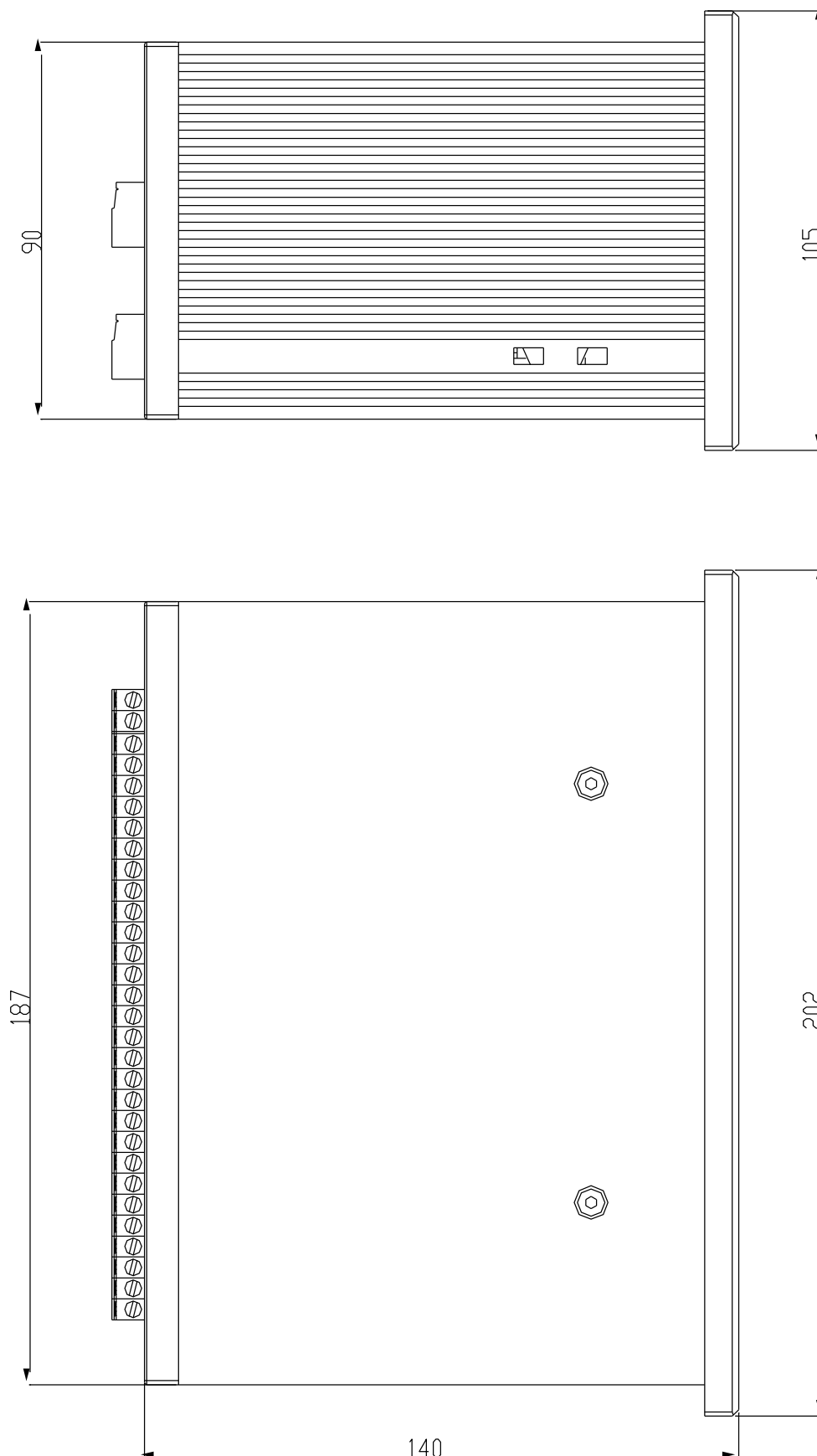

Figure 1

DRILLING TEMPLATE DIMENSION: 187,5mm x 91,5mm

3.2 3590E CASE AND DIMENSIONS

ABS MODEL

The indicator has an IP65 ABS case, whose external dimensions are shown in the Figure. It can be simply put on a table or fixed to a shelf or column available on request.

NOTE: If the identification plate is supplied separately (therefore not attached to the indicator), it is advisable to attach it to the indicator, in order to be able to identify the instrument.

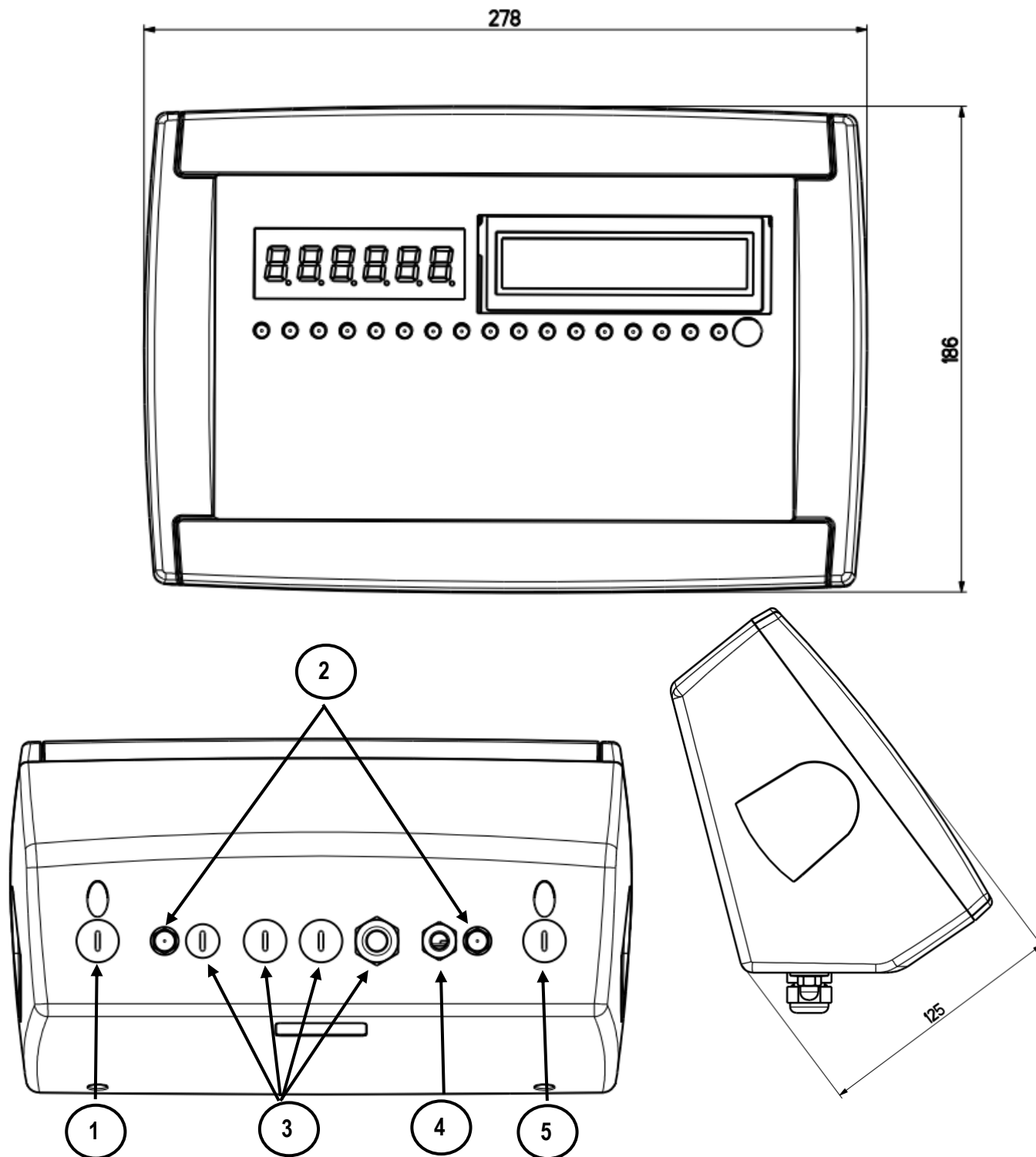

Figure 2 – Measurements and dimensions in mm

- 1) RJ45 connector
- 2) Fixing for shelf or column mounting
- 3/5) Available for load cells / serial lines / inputs / outputs.
- 4) Power supply input.

STAINLESS STEEL MODEL

The indicator has an STAINLESS STEEL case, whose external dimensions are shown in the Figure 3. It can be simply put on a table or fixed to a shelf or column available on request.

NOTE: If the identification plate is supplied separately (therefore not attached to the indicator), it is advisable to attach it to the indicator, in order to be able to identify the instrument.

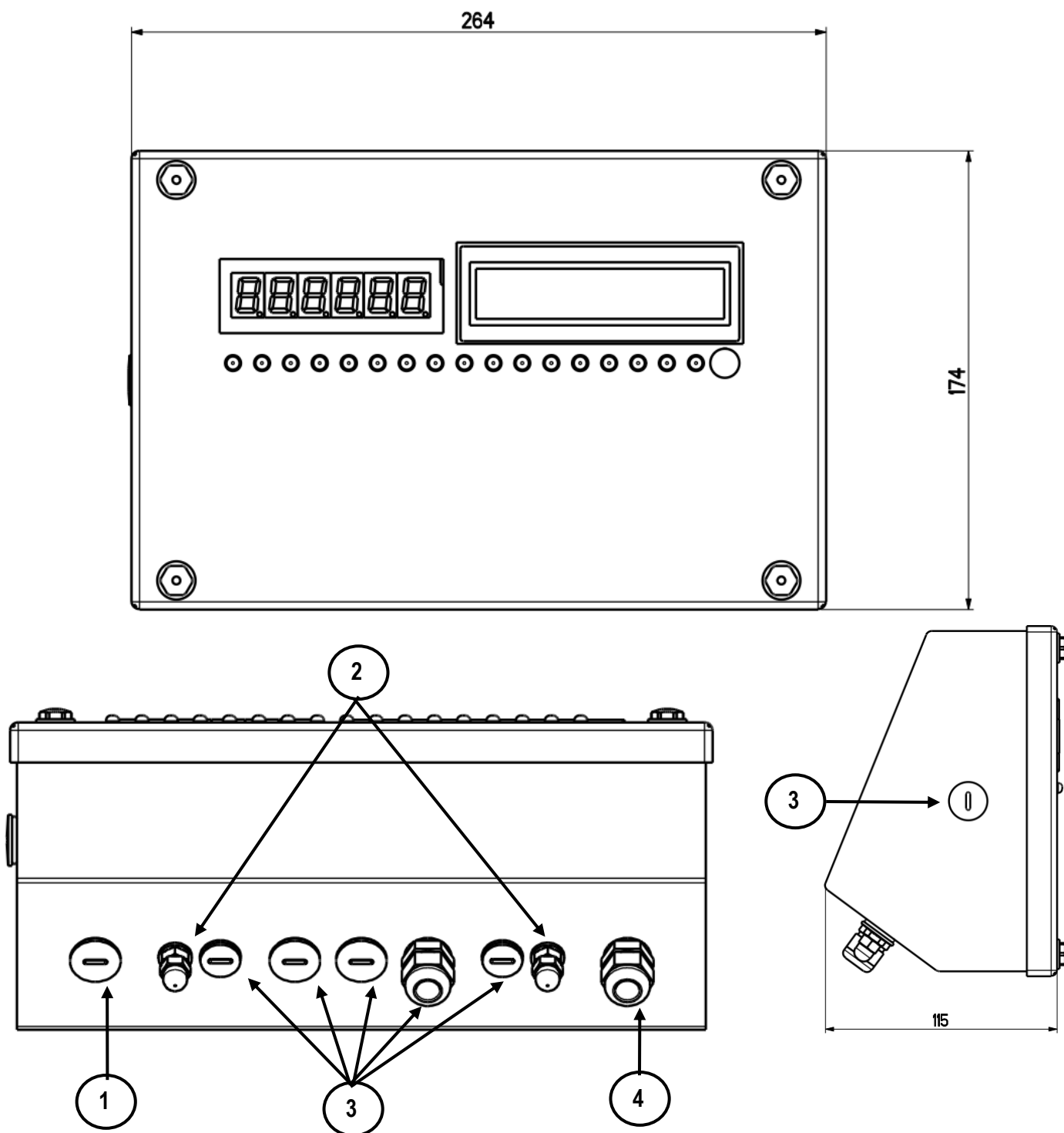

Figure 3 – Measurements and dimensions in mm

- 1) RJ45 connector
- 2) Fixing for shelf or column mounting
- 3) Available for load cells / serial lines / inputs / outputs.
- 4) Power supply input.

3.3 CPWET CASE AND DIMENSIONS

The weight indicator has an STAINLESS STEEL case, whose external dimensions are shown in the figure 4. The instrument may be installed on the wall.

NOTE: If the identification plate is supplied separately (therefore not attached to the indicator), it is advisable to attach it to the indicator, in order to be able to identify the instrument.

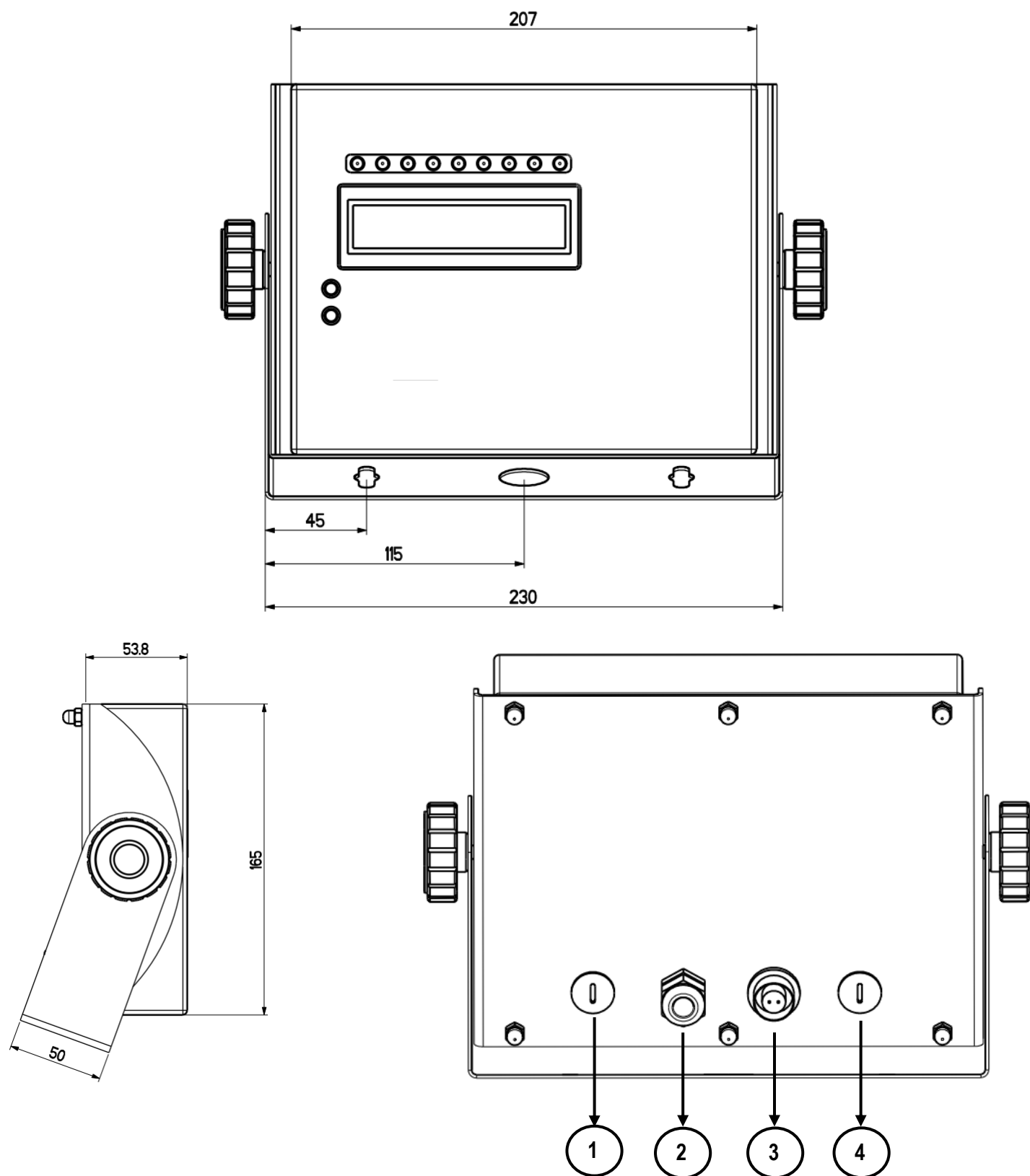

Figure 4 – Measurements and dimensions in mm

1/2) Available for load cells / serial lines / inputs / outputs

3) Power supply input.

4) RJ45 connector

3.4 CPWETF CASE AND DIMENSIONS

The weight indicator has a STAINLESS STEEL case, whose external dimensions are shown in figure 5. The instrument may be installed on the wall.

NOTE: If the identification plate is supplied separately (therefore not attached to the indicator), it is advisable to attach it to the indicator, in order to be able to identify the instrument.

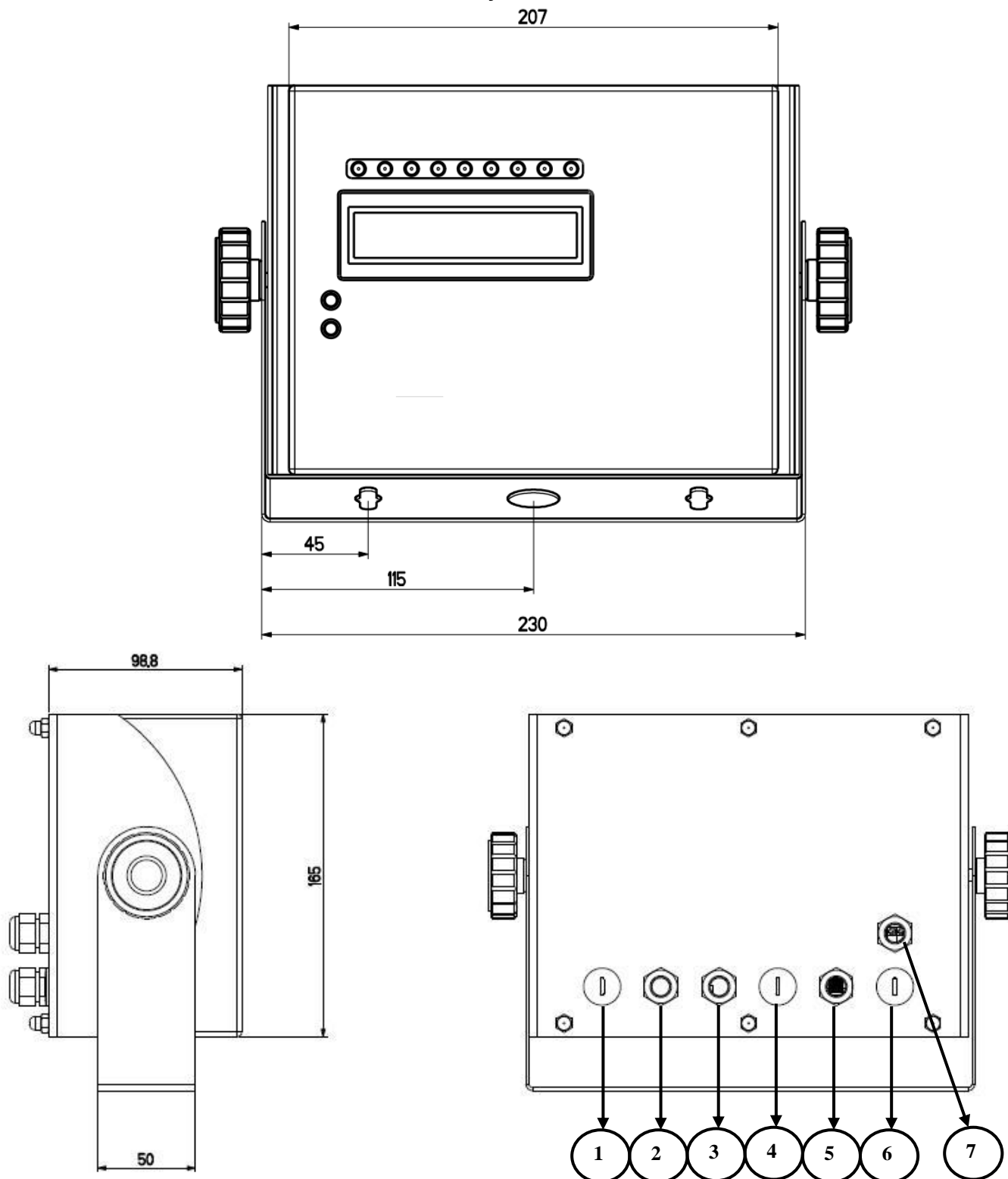

Figure 5 – Measurements and dimensions in mm

1/4/6) Available for load cells / serial lines / inputs / outputs

2) Ethernet

3) Profibus

5) RJ45 connector

7) Power supply input.

3.5 POWER SUPPLY

- The 3590E indicator is powered with 12Vdc voltage (8 ÷ 36 Vdc in the IO version), through an internal adapter which converts the 100 ÷ 240Vac, 50÷60Hz mains voltage, and 6 Vdc, from the built-in battery (fitted depending on the model). **TO POWER** the instrument through the 240 Vac mains, or **TO RECHARGE** the battery, insert the plug and the adapter to the 240 Vac mains socket.

- The CPWE indicator is powered with 8÷36 Vdc voltage or a 6 Vdc external battery (upon request).
- The CPWET indicator is powered with 12 Vdc voltage or with 6 Vdc external battery (upon request).

To connect the indicator to the power mains, the safety regulations must be observed, including the use of a "clean" line without disturbances or interference caused by other electronic equipment.

Version with rechargeable battery: The battery inside the indicator, lasts about 25 hours (without the expansion board, with 1-cell platform) and it needs a recharging time of about 12 hours.

BATTERY FEATURES

Material	LEAD
Power	4,5 Ah
Voltage	6 V

THE BATTERY MUST BE SUPPLIED DIRECTLY FROM THE MANUFACTURER.

NOTE: *it is advisable to completely recharge it (12 hours) in the first installation of the instrument; we RECOMMEND disconnecting the battery if the instrument is not going to be used for more than 30 days.*

Do not connect other equipment to the same socket as the one that the adapter is in.

Do not step on or crush the power supply cable

3.6 START UP

TO TURN ON the 3590E or the CPWET press the **C** key until the display turns on; then release.

The CPWE instead is automatically turned on as soon as it is powered.

The display shows:

- Initially a welcome message (settable in the TECHNICAL SET-UP, << LoGo >> StEP, **TECH.MAN.REF**) while the instrument carries out a series of checking and preheating self tests.
- E-AF03 - XX" name of the installed software, in which XX identifies the software language.
XX.YY is the software version installed.
- "EXECUTION AUTOZERO"

The instrument carries out the "autozero at start-up" function: if a weight is detected within the percentile set in the << **Auto-0** >> step (**TECH.MAN.REF.**), it is cleared; if the weight is not within this tolerance:

- with a non approved instrument, the display shows the weight after a few instants,
- with an approved instrument, the message "EXECUTION AUTOZERO" appears continuously on the display, until the weight is within tolerance.

The auto zero function at start-up may be disabled in the set-up environment (only with non approved instrument); see **SEtuP >> ConFiG >> PArAm. >> Auto-0 (TECH.MAN.REF.)**

By pressing the **2ndF** key for an instant while the version is shown in the display, the indicator will shown in this order:

01.01 in which 01 indicates the instrument type, 01 indicates the metrological software version.

XX.YY.ZZ is the installed software version.

HH is the installed hardware version (08).

LEGAL FOR TRADE or HIGH RESOLUTION if the instrument is APPROVED or UNAPPROVED, respectively.

9.XXXXX is the the g gravity value (only with APPROVED instrument).

3.7 TURNING OFF THE INSTRUMENT

TO TURN OFF the 3590E or **TO RESTART** the CPWE keep the C key pressed until the "- OFF -" message appears on the LED display and " *** POWER OFF *** " on the LCD display.

TO TURN OFF the CPWE remove the instrument's power supply

3.8 TURNING ON PRINTER IN ENERGY SAVING MODE

Premise: the **SEtuP >> SEriAL >> CoMPrn >> PWRPrn** parameter must be set as **“Ext.oFF”** or **“PWrint”**, **TECH.MAN.REF**).

In a system where the indicator is connected to a printer, and both are battery powered, the printer is normally maintained in STAND-BY and powered only when a printout is needed. This function reduces the energy absorbed by the battery when the printer is not being used.

If, in this configuration, one should power the printer to change the paper and other maintenance jobs, one needs to press in sequence the **ENTER** and **0** keys during the weighing: the display shows **Prn - on**, and the printer is kept on. Press any key to exit from this condition.

4. FRONT PANEL KEYS AND DISPLAYS

3590E

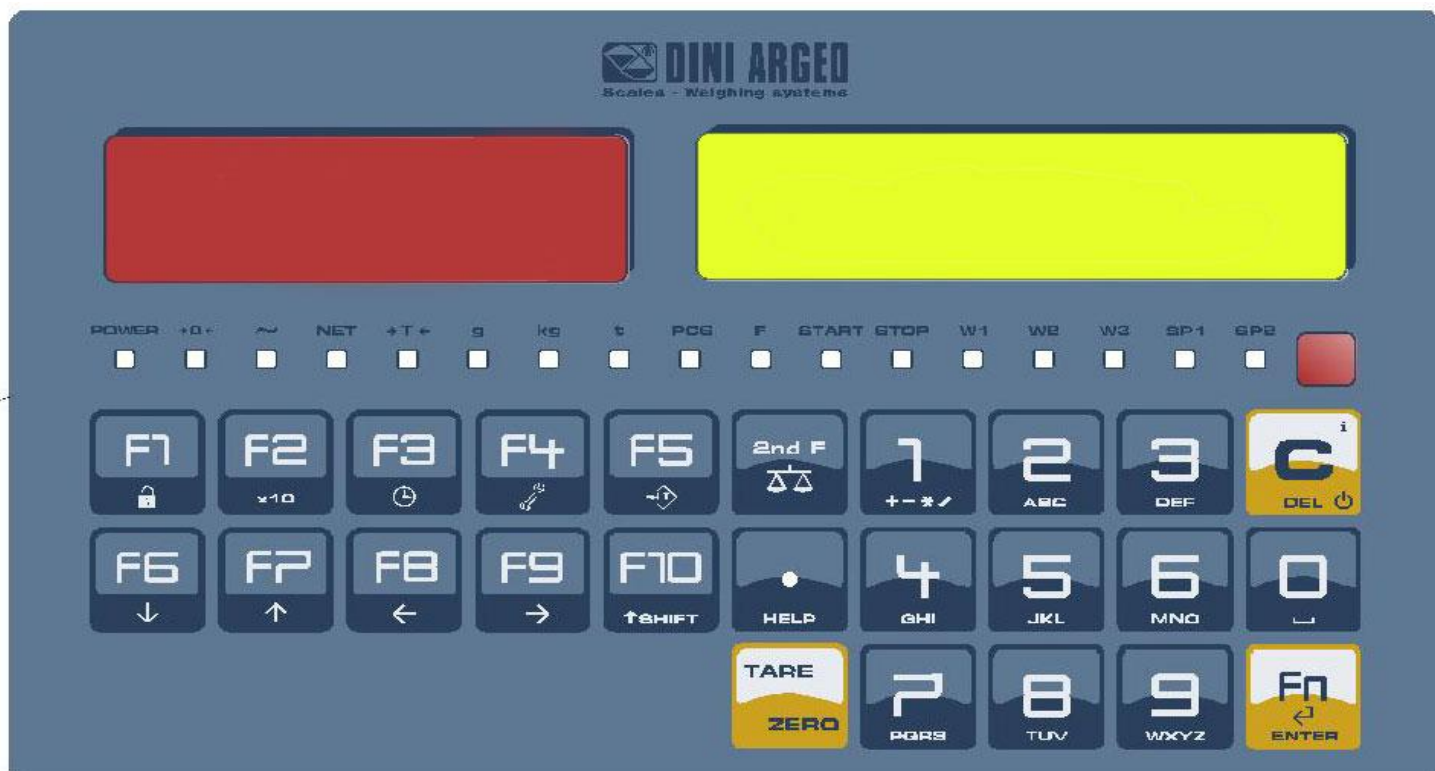

CPWE



CPWET/CPWETF

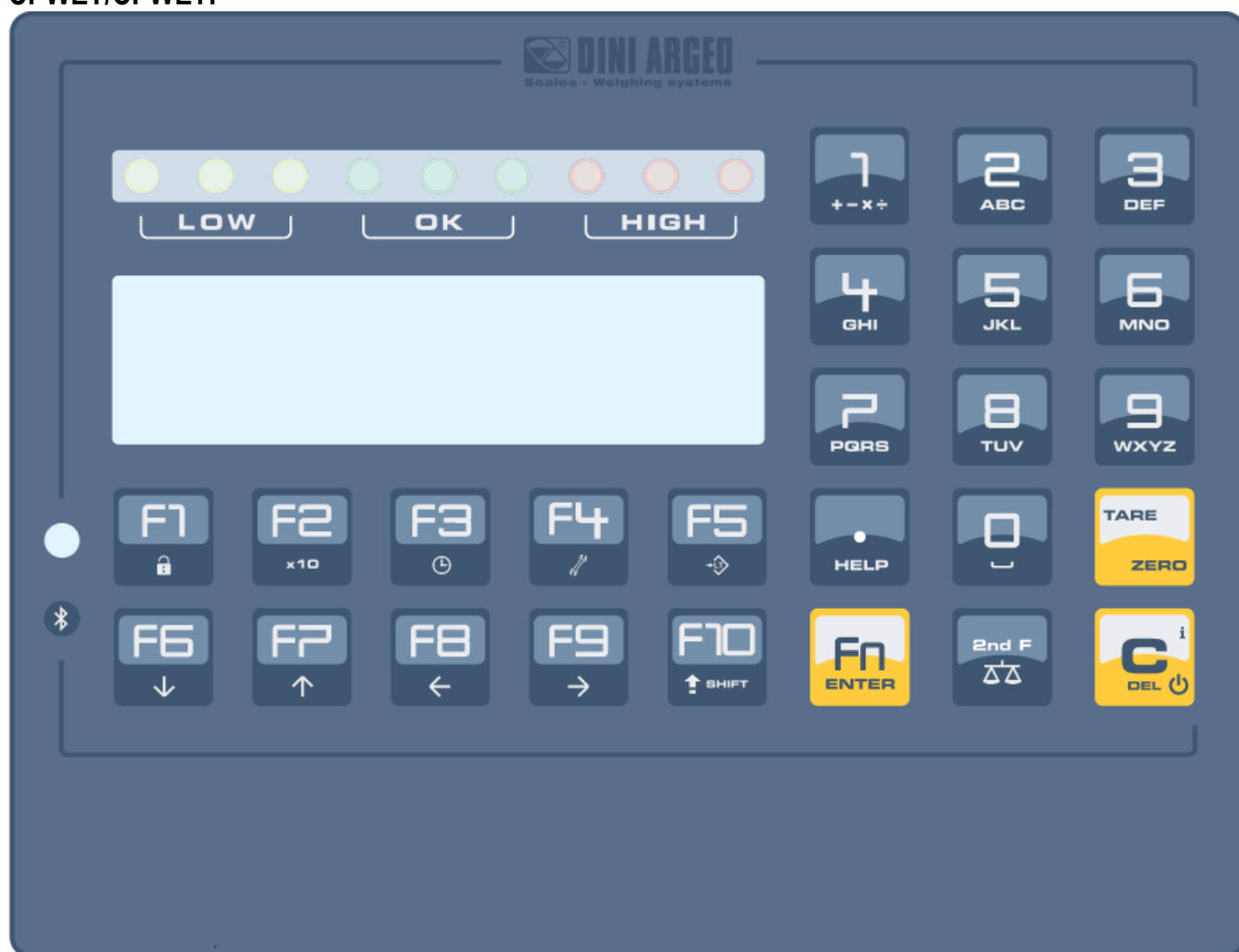

4.1 FUNCTION OF THE KEYS

In the following section, and later on in the manual, the keys' functioning is described in accordance to how these are configured by the factory.

It is possible to customise the functionality of the keys through the << F.KEYS >> step.

C/DEL	<ul style="list-style-type: none"> - Turns the instrument on/off. - If pressed for an instant, it clears the tare value. - Exits the parameter without confirming and saving the modifications. - In the numeric input phase, it quickly clears the present value.
TARE/ZERO	<ul style="list-style-type: none"> - If pressed for an instant it carries out the semiautomatic tare, or cancels the value of tare if the gross weight is 0. - If pressed at length, it clears the displayed gross weight, if it's within the percentage configured in the << 0.PErC >> step.
Fn/ENTER	<ul style="list-style-type: none"> - In the alphanumeric input phase, it confirms the entry made. - In the menu it allows to enter a step or to confirm a parameter inside a step.
2nd F	<ul style="list-style-type: none"> - If pressed together with the other keys, it allows carrying out a specific function. (see section 4.1.1).
./HELP	<ul style="list-style-type: none"> - In the numeric or alphanumeric input phase, it enters, in this order, the following characters: . , ; : # < > \ ' " % & / () = ? ^ ' [] { } ; - HELP function, see section 4.1.4. - If pressed in some steps or functions of the weight indicator, the display shows the keys and their functions specific to that state of the instrument.

F1	<ul style="list-style-type: none"> - By entering a number through the numerical keyboard and then pressing the F1 key, one can quickly select the customer corresponding to the entered value (the article must have already been edited). - If pressed for an instant it allows entering the customer database. - If pressed at length one locks and unlocks the instrument's keyboard (except the C key)
F2	<ul style="list-style-type: none"> - By entering a number through numerical keyboard and then pressing the F2 key, one can quickly select the material corresponding to the entered value (the article must have already been edited). - In the input numeric or alphanumeric phase, you have the possibility to paste the characters that you have copied - If pressed for an instant it allows entering the material database. - If pressed at length the weight visualization function with sensitivity x 10 is enabled.
F3	<ul style="list-style-type: none"> - By entering a number through numerical keyboard and then pressing the F3 key, one can quickly select the vehicle corresponding to the entered value (the article must have already been edited). - If pressed for an instant it allows entering the vehicle database. - If pressed at length one can adjust the date and time of the instrument.
F4	<ul style="list-style-type: none"> - If pressed for an instant it allows filling in the free texts, if configured. - If pressed at length one enters the instrument's diagnostics menu.
F5	<ul style="list-style-type: none"> - Commands the data transmission to the printer serial port. - If pressed at length one locks/unlocks the tare.
F6	<ul style="list-style-type: none"> - If pressed for an instant it allows carrying out an input weigh. - Allow to scroll forwards in the menu steps or in the parameters inside a step. - In the numeric or alphanumeric input phase, it decrements the blinking digit.
F7	<ul style="list-style-type: none"> - If pressed for an instant it allows carrying out an output weigh. - Allow to scroll backwards in the menu steps or in the parameters inside a step. - In the numeric or alphanumeric input phase, it increments the blinking digit.
F8	<ul style="list-style-type: none"> - If pressed for an instant it allows printing and resetting the partial total. - In the numeric or alphanumeric input phase, it selects the digit to be modified from right to left.
F9	<ul style="list-style-type: none"> - If pressed for an instant it allows printing and resetting the general total. - In the numeric or alphanumeric input phase, it selects the digit to be modified from left to right.
F10	<ul style="list-style-type: none"> - If pressed for an instant, it executes the printing and the zeroing of the large total. - In the numeric or alphanumeric input phase, introduces a space between two characters.
NUMERICAL KEYBOARD	<ul style="list-style-type: none"> - Entry of digits or characters. - During the weighing, these enter a numeric value with which it's possible to: <ol style="list-style-type: none"> 1) Set the tare value, by pressing then the TARE key (see section 7.2). 2) To add or to subtract to the current tare the result of the operation between two values enterable with the keyboard (See the 15.1 CALCULATOR section).

4.1.1 "2ndF" KEY: SECOND FUNCTION OF THE KEYS

In the weighing phase, by pressing the **2ndF** key together with another key, it's possible to execute various functions (continue reading the manual for the details of the functions):

2ndF	F1	Print/Clearing of Customer Total
2ndF	F2	Print/Clearing of Material Total
2ndF	F3	Print/Clearing of Vehicle Total
2ndF	F4	Deselect databases
2ndF	F5	Repetition of the last printout made
2ndF	F8	Net/Gross Conversion ¹
2ndF	C	Causes the display of the present metric scale information (see section 8).
2ndF	TARE/ZERO	Cyclical scale zero on the connected scales
2ndF	0	Selection of remote scale
2ndF	1	Selection of scale 1
2ndF	2	Selection of scale 2
2ndF	3	Selection A+B function

4.1.2 ENTERING ALPHANUMERIC TEXT

It might be necessary, while the weighing system is working, to enter some alphanumerical texts such as descriptions, alphanumerical messages (operator, number of lot, customer, etc.).

To enter the characters one uses the **0** to **9** keys.

By pressing one of these keys a few times, the characters shown on the key (and other special characters) will be shown on the LCD display: initially the first letter in the bottom left will appear, and then the other characters towards the right.

After digiting a character, the blinking cursor, after a few instants, advances automatically of a position.

Function of the keys

F5	switches the writing mode from "numeric" (nuM) to "characters" (ChAr). In the nuM mode one enters <u>just the numbers</u> , while in the ChAr mode one can enter <u>all the characters of a key</u> .
C	If pressed for an instant, it cancels the written characters: first the characters that follow the cursor are cancelled; than those that precede it, one at a time. If pressed at length, it deletes all entered characters. With empty text, it exits the entry phase without confirming.
SHIFT	It enters a space in the middle of a text.
./HELP	If pressed a few times it allows entering the following characters: ., ; : # < > \ " ' % & / () = ? ^ ' [] { }.
0	In "characters" mode (ChAr), by pressing once a space is entered ; by pressing twice it enters the "0" character.
1	In "characters" mode (ChAr), pressed repeatedly, it allows to enter the following symbols: ? ! 1 @ ' + - * / = ~ € „ … † ‡ ± % ∞ š < OE ž ı ' " • - - ~ ™ Š > oe ž č £ ¤ ¥ ¦ § ¨ © ª « ¬ - ® ¯ ° ± ² ³ ´ μ ¶ · ¸ ¹ º » ¼ ½ ¾ ¿ ã.
◀ ▶	Moves the blinking cursor to the left or to the right.
▲ ▼	Scrolls in one sense or the other the list of all the enterable characters (0, 1...9, A, B...Y, Z)

¹ In case of APPROVED instrument and active tare, the gross weight will show for about 5 seconds, then return to the net weight visualization.

Examples:

- To enter the letter “B” one should press the “2” key twice in the **ChAr** mode.
- To enter the number “3” one should press the “3” key four times (in the **ChAr** mode) or press the F5 key (one passes to the **num** mode) and press the “3” key once.

4.1.3 DISABLING THE KEYBOARD

It is possible to disable all the keyboard functions (except the **C** key for turning on and off), in order to avoid undesired pressings of the scale keys:

- **To lock the keyboard**, press at length the **F1** key: the display shows the “LoCK” message for a few instants. Now the keyboard is LOCKED: if one presses a key, the display shows for a few instants the “HOLD F1 TO UNLOCK” message.
- **To unlock the keyboard**, press again at length, the **F1** key: the display shows the “unLoCK” message for a few instants.

NOTE: It’s possible to lock all keys individually in a permanent way through the TECHNICAL SET-UP, **TECH.MAN.REF.**

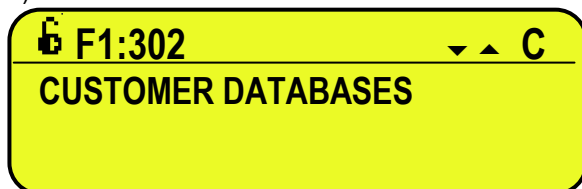

4.1.4 HELP MENU

By pressing at length the **HELP** key it is possible to access a menu containing the list of keys with the relative function, and status (locked or unlocked) indication.



The display shows:

- in the upper part: the key, followed by the code of the linked function in the << **F.Keys** >> step, and a symbol

Indicating whether the key is unlocked () or locked () in the << **EN.KEYS** >> step.

- in the lower part: the description of the linked function.

Scroll the list with the arrow keys   , press the **C** key to exit.

4.1.5 3590EQXP



<p>CLEAR</p>	<ul style="list-style-type: none"> - Turns the instrument on/off. - If pressed for an instant, it clears the tare value. - Exits the parameter without confirming and saving the modifications. - In the numeric input phase, it quickly clears the present value.
<p>>T< TARE</p>	<ul style="list-style-type: none"> - If pressed for an instant it carries out the semiautomatic tare, or cancels the value of tare if the gross weight is 0.
<p>>0< ZERO</p>	<ul style="list-style-type: none"> - If pressed at length, it clears the displayed gross weight, if it's within the percentage configured in the << 0.PErC >> step.
<p>Fn/ENTER</p>	<ul style="list-style-type: none"> - In the alphanumeric input phase, it confirms the entry made. - In the menu it allows to enter a step or to confirm a parameter inside a step.
<p>2nd F</p>	<ul style="list-style-type: none"> - If pressed together with the other keys, it allows carrying out a specific function. (see section 4.1.6). - Caps Lock: in phase of numeric or alphanumeric input, it insert capital letters or the special characters on the numebers or above the accented letters.
<p>• HELP</p>	<ul style="list-style-type: none"> - in phase of numeric or alphanumeric input, it introduce in order the following characters: . ? ; - HELP function, see paragraph 4.1.4. - if pressed in some steps or functions of the weight indicator, the display shows keys and their specific functions in the current state of the instrument.

F1	- It allows to insert a client in the clients' database, a material in the materials' database, a vehicle in the vehicles' database.
F2	- It allows to modify a client in the clients' database, a material in the materials' database, a vehicle in the vehicles' database - Pressed for an instant, it prints and resets the subtotal .
F3	- It allows to delete a client in the clients' database, a material in the materials' database, a vehicle in the vehicles' database. - Pressed for an instant, it prints and resets the general total.
F4	- Pressed for an instant, it prints and resets the grand total.
F5 TEXT	- If pressed for an instant it allows filling in the free texts, if configured.
F6 CUSTOMER	- If pressed for an instant it allows entering the customer database - In the numeric or alphanumeric input phase, it selects the digit to be modified from right to left.
F7 MATERIAL	- If pressed for an instant it allows entering the material database. - Allow to scroll forwards in the menu steps or in the parameters inside a step. - In the numeric or alphanumeric input phase, it decrements the blinking digit.
F8 VEHICLES	- If pressed for an instant it allows entering the vehicle database. - In the numeric or alphanumeric input phase, it selects the digit to be modified from left to right.
IN F9	- If pressed for an instant it allows carrying out an input weigh.
OUT F10	- If pressed for an instant it allows carrying out an output weigh.
NUMERICAL KEYBOARD	- Entry of digits or characters. - During the weighing, these enter a numeric value with which it's possible to: Set the tare value, by pressing then the TARE key (see section 7.2). To add or to subtract to the current tare the result of the operation between two values enterable with the keyboard (See the 16.1 CALCULATOR section).
ESC INFO	- Pressing it long, Causes the display of the present metric scale information (see section 8). - If pressed for an instant it allows to select the scale 1, 2 or the remote scale.
1	- If pressed at length one locks and unlocks the instrument's keyboard (except the C key).
2	- If pressed at length the weight visualization function with sensitivity x 10 is enabled.
3	- If pressed at length one can adjust the date and time of the instrument.
4	- If pressed at length one enters the instrument's diagnostics menu.

5	- If pressed at length one locks/unlocks the tare.
6	- If pressed at length, it enable the calculator function (see the paragraph 16.1 CALCULATOR)
7	- If pressed at length, it repeats the last printout
8 ON	- If pressed at length, it turn on the printer in case of printer internal power.
9 TEST	- If pressed at length, it access to the peripheral devices diagnostic (P.DIAG.)
0	- If pressed at length, it access to the serial data diagnostic (COM.DAT)

4.1.5.1 "2ndF" KEY: SECOND FUNCTION OF THE KEYS 3590EQXP

In the weighing phase, by pressing the 2ndF key together with another key, it's possible to execute various functions (continue reading the manual for the details of the functions):

2ndF	F6	Print/Clearing of Customer Total
2ndF	F7	Print/Clearing of Material Total
2ndF	F8	Print/Clearing of Vehicle Total
2ndF	F5	Deselect databases
2ndF	F1	Net/Gross Conversion ²
2ndF	TARE/ZERO	Cyclical scale zero on the connected scales

² In case of APPROVED instrument and active tare, the gross weight will show for about 5 seconds, then return to the net weight visualization.

4.1.6 INDICATOR CONNECTED TO PC KEYBOARD

It's possible to connect a PC keyboard (optional), used to emulate the functions of the keys of the indicator.

The keys are managed in the following way:

KEYBOARD	KEY OR FUNCTION EMULATE
Esc	-C key. - If pressed at start-up, it allows entering in the technical set-up. In the alphanumeric input, it deletes all entered characters.
← and Canc	-C key. - If pressed at start-up, it allows entering in the technical set-up. In the alphanumeric input, it cancels first the characters which follow the cursor, then the ones which precede it, one at a time.
Enter ↵	-Fn key. - Confirms the entered value. - Enters the displayed step
Numeric and alphanumeric keys, SHIFT and CAPS LOCK	- Quick entry of a numeric and alphanumeric string: through the CAPS/LOCK or SHIFT key it is possible to switch from the capital letters to the lower case letters, and vice versa, or enter the second character corresponding to the key (for example " , % , & , / , ?)
Cursor keys ↑ ↓	- Scroll the parameters - Increase or decrease the blinking digit while entering a value.
Cursor keys ← →	- When entering a value or an alphanumeric string, it scrolls the digits to the right or to the left.
F1, F2....F10	F1,F2....F10 keys.
F11	2ndF key
F12	TARE key.

NOTE: through the remote keyboard, it's not possible to carry out the functions made by pressing the keys at length.

4.1.6.1 DIRECT COMPILATION OF INPUT TEXT

By entering an alphanumeric text through an external keyboard the instrument goes into insertion mode; by pressing a function key from F1 to F9, programmed with a direct function to fill in an input text (121 up to 130) the edited alphanumeric text is assigned to the corresponding input text.

The alphanumeric display contains up to 32 characters.

4.1.7 REMOTE CONTROL

Depending on the indicator model, it is possible to remotely control the instrument through one of the following types of remote controls: 19-key infrared (ir) or 6-key radio (rd).

The type of remote control to be used must be selected in the Setup environment, in the << inF.Red >> step (TECH.MAN.REF).

NOTE: The infrared remote controls are for indoor use only.

4.1.7.1 "19-KEY" INFRARED REMOTE CONTROL

With this type of remote control, the functioning of the keys will be as described in the following table.

FUNCTION OF THE KEYS



KEYBOARD	KEY OR FUNCTION EMULATED
F1...F3	F1...F3 keys
C	C key
NUMERIC KEYS	Entry of digits
TARE / ▲	Tare/zero function or increase of a digit while entering a value
.	./HELP key
ZERO / ▼	Decrease of a digit while entering a value
MODE / →	Scrolls the digits to the right while entering a value
PRINT / ←	Confirms the entered value or enters the displayed step

4.1.7.2 "6-KEY" RADIO REMOTE CONTROL

With this type of remote control, the functioning of each key can be programmed so that it is matched to one of the available keys of the indicator.

This configuration must be carried out in the Setup environment, in the << inF.Red >> step (**TECH.MAN.REF**), after the selection of this type of remote control.

By pressing the **.HELP** key of the indicator, it's possible to see, while weighing, the list of the functions matched to the keys of the indicator and also to the keys of the remote control (see section 4.1.4).

EXAMPLE OF CONFIGURATION

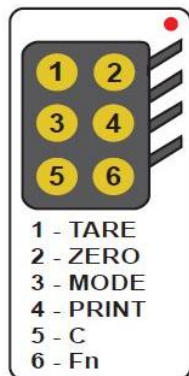

USE OF MORE REMOTE CONTROLS WITH ONLY ONE INDICATOR

If one works with only an indicator, it is possible to use any 6-key remote control, without combining it to the indicator, therefore without limiting the number of usable remote controls.

To enable this mode one has to first select "RD 6 BR" in the << inF.Red >> (**TECH.MAN.REF**).

USE OF MORE REMOTE CONTROLS WITH SEVERAL INDICATORS IN THE SAME AREA

If one needs to use several indicators in the same area, it is possible to combine each remote control to the desired indicator, in order to execute the function only on it and therefore avoid emulating the function on all indicators in use.

By enabling this mode it will be possible to combine up to 3 different remote controls (e.i. for 3 different operators) for each indicator.

To enable this mode one has to first select "RD 6" in the << inF.Red >> (**TECH.MAN.REF**).

To link a new remote control to the indicator one has to:

- press at length 1 and 2 keys together (3 seconds).
- the instrument displays "aut.rd?"
- press the ENTER key of the indicator
- the new remote control is linked

To remove the linking of a remote control one has to:

- press at length 1 and 2 keys together (3 seconds).
- the instrument displays "aut.rd?"
- press the C key of the indicator; if the remote control was previously linked, it will be removed.

4.2 FUNCTION DISPLAY

During the weighing the displays are subdivided mainly in 3 sections, shown in the figures below:

- 1) WEIGHT
- 2) STATUS INDICATORS (led pilot lights and / or graphic symbols)
- 3) DATA (two lines in the 3590E; one or two lines in the CPWE, depending on the weight zoom function, described in the following section).

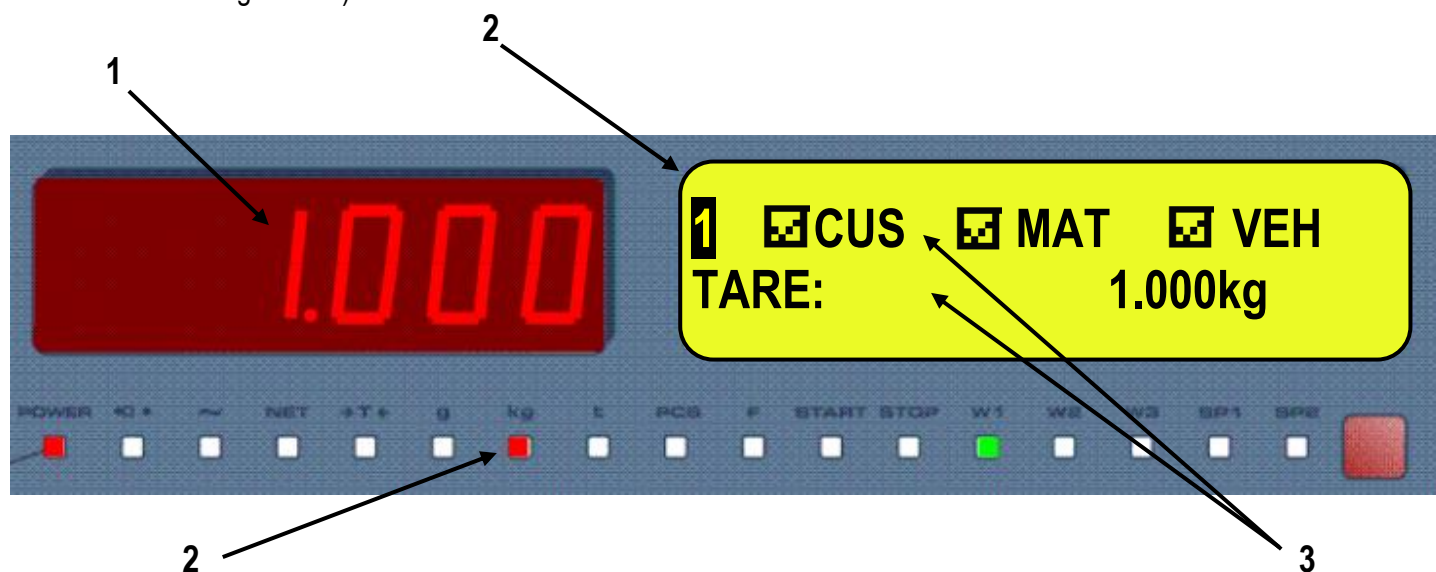

Figure 1: 3590E displays

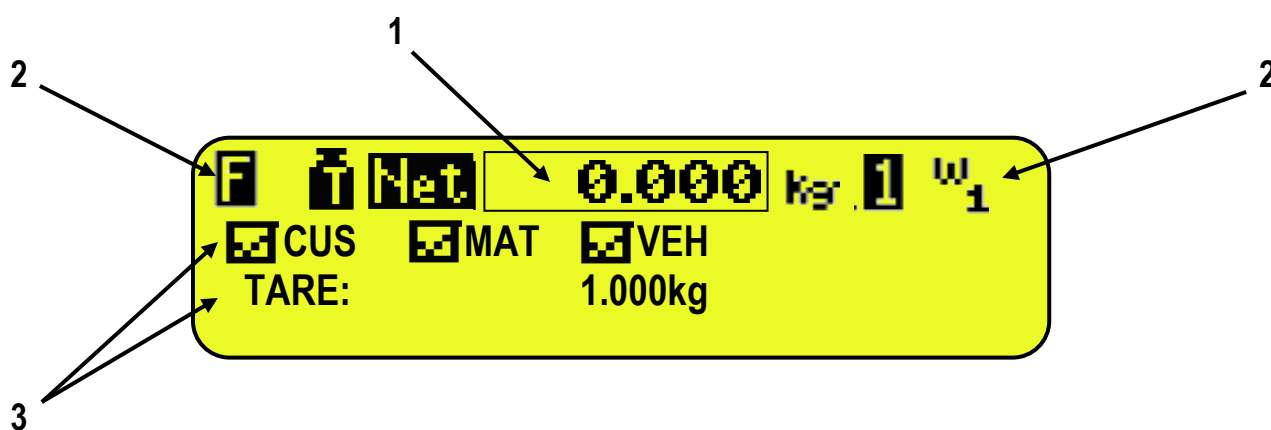
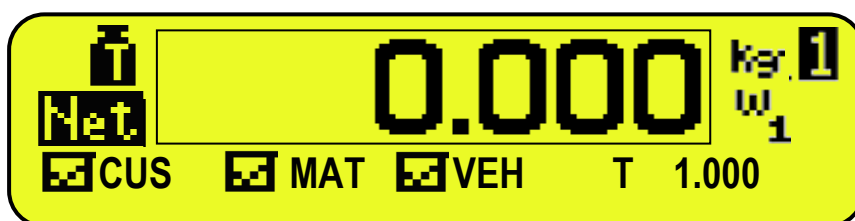

Figure 2: CPWE/CPWET display

NOTE: If the EEEEE message appears, this means that the value exceeds the maximum number of digits shown by the instrument.

4.2.1 WEIGHT ZOOM

The zoom function allows to increase the size of the weight digits, in order to ease the reading from a distance; with the active zoom, the data is shown on a single line.











Through the << ZOOM.W >> step, one can disable/enable the function and set a delay which determines the activation mode:

- always active function (with delay equal to 0), or
- disabled function at the pressing of a key and reenabled automatically when the keyboard inactivity time reaches the configured delay period (with delay greater than 0).

4.2.2 STATUS INDICATORS

LED	FUNCTION
POWER	Indicates the type of indicator power supply: - red pilot light: through built-in power adapter; - green pilot light: through battery (charged battery); - pilot light off: through battery (discharged battery).
→0←	Indicates that the weight detected by the weighing system is near zero, including the interval of $1/4 + 1/4$ of the scale's division.
~	Indicates that the weight is unstable.
NET	Indicates that the weight shown by the LED display is a NET WEIGHT.
→T←	Indicates that a tare value has been acquired or entered.
G	Indicates that the unit of measure in use is the gram.
Kg	Indicates that the unit of measure in use is the kilogram.
T	Indicates that the unit of measure in use is the ton.
PCS	Not used in this application
F	Not used in this application
START	Not used in this application
STOP	Not used in this application
W1 W2 W3	See section 8
SP1	Not used in this application
SP2	Not used in this application

SYMBOLS SHOWN ON THE LCD DISPLAY

SYMBOL	FUNCTION
	The weight detected by the weighing system is near the zero, included within the interval of $-1/4$ and $+1/4$ of the scale division.
	The weight is unstable.
	The displayed weight is a GROSS WEIGHT (depending on the software language).
	The displayed weight is a NET WEIGHT.
	A tare value has been acquired.
	A manual tare value has been entered.
	Unit of measure in use: ton, kilogram, gram, pounds, millilitres, or millivolts.
	Active weighing range, see section 8.
	Active scale (see section 5).

	Indicates that a specific function of the instrument is active.
	Battery charge level: see section 5.2.1.
	Status output, respectively non active and active. Icon viewable only with active DIAGNOSTICS PERIPHERAL UNITS function, see section 15.1.
	Status input, respectively non active and active. Icon viewable only with active DIAGNOSTICS PERIPHERAL UNITS function, see section 15.1.
	Serial communication status with external device. Icon viewable only with active DIAGNOSTICS PERIPHERAL UNITS function, see section 15.1.
	Active during the configuration of the date and time.
	Locked keyboard, see section 4.3
	In the HELP menu these respectively indicate whether a key is unlocked or locked in the SETUP level (<< En.KEYS >> step, see section 4.4.)
	The Fn key has been pressed.
	The 2nd F key has been pressed.
	Transmission of the data to the printer serial port under way.
	Inside the step, these respectively indicate an unselected or selected parameter.
	They indicate respectively if an element of archive is unselected or selected (see section 4.2.5).
	Active calculator function, see section 15.1 CALCULATOR.

4.2.3 BATTERY LEVEL INDICATION

The indicator is able to recognise whether it is powered by mains or by battery, and to indicate its charge level; to enable the battery level indication, one should configure the << bt.LEVEL >> step.

The charge level is shown during weighing by the battery symbol.

- : charged battery.
- : partially charged battery.
- : discharged battery: connect the indicator to the mains for recharging the battery (if provided by that model) or replacing the battery.

The indicator shows also when the battery is being recharged (if provided for the model):

RECHARGE PHASE: → → → → ...

COMPLETED RECHARGE:

NOTES:

- During the recharge the instrument can be normally used.
- The instrument automatically turns off when the voltage goes below the minimum level.

4.2.4 "TILT" DEVICE

The TILT is a device which inhibits the indicator's weighing system and starts working when the instrument's inclination is greater than 2% for the pallet truck application or 5% for application on lift trucks.

The "tilt" message is shown on the display, alternate to the weight value.

The activation of the tilt alarm has a delay of about three seconds from the detection of the exceeding inclination.

See the electrical connection scheme (**TECH.MAN.REF.**) for the connection of the device.

4.2.5 DISPLAYED DATA

3590E

The data is displayed on two lines:

VISUALISATION WITH ENABLED DATABASES	EXAMPLES	
	A+B FUNCTION DISABLED	A+B FUNCTION ENABLED
<ul style="list-style-type: none"> - Indication of the selected elements (CUS:customer/MAT:material/VEH:vehicle): <input checked="" type="checkbox"/> Element selected <input type="checkbox"/> Element not selected - Active semiautomatic tare (PT if manual tare) or weight on the scale 1 and 2 		

VISUALISATION WITH DISABLED DATABASES	EXAMPLES	
	A+B FUNCTION DISABLED	A+B FUNCTION ENABLED
<ul style="list-style-type: none"> - Gross weight or weight sum (A+B) - Active semiautomatic tare (PT if manual tare) or weight on the scale 1 and 2 		

CPWE/CPWET**VISUALISATION WITH NON ACTIVE WEIGHT ZOOM**

The data is shown on two lines under the "weight" section.

VISUALISATION WITH ENABLED DATABASES	EXAMPLES	
	A+B FUNCTION DISABLED	A+B FUNCTION ENABLED
<ul style="list-style-type: none"> - Indication of the selected elements (CUS:customer/MAT:material/VEH:vehicle): <input checked="" type="checkbox"/> Element selected <input type="checkbox"/> Element not selected - Active semiautomatic tare (PT if manual tare) or weight on the scale 1 and 2 		

VISUALISATION WITH DISABLED DATABASES	EXAMPLES	
	A+B FUNCTION DISABLED	A+B FUNCTION ENABLED
<ul style="list-style-type: none"> - Gross weight or weight sum (A+B) - Active semiautomatic tare (PT if manual tare) or weight on the scale 1 and 2 		

VISUALISATION WITH ACTIVE WEIGHT ZOOM

The data is shown on one line under the “weight” section.

VISUALISATION	EXAMPLES	
	WITH ENABLED DATABASES	WITH DISABLED DATABASES
- Indication of the selected elements or gross weight/weight sum (A+B) (CUS:customer/MAT:material/VEH:vehicle): <input checked="" type="checkbox"/> Element selected <input type="checkbox"/> Element not selected		

5. SELECTION OF THE SCALE

With various scales connected, press the **2ndF** key followed by a key from 0 to 3:

- 0 >> Selection of remote scale.
- 1 >> Selection of scale number 1.
- 2 >> Selection of scale number 2.
- 3 >> A+B function.

For example with the **2ndF** and the **1** keys, the words “SCALE 1” appear on the display for a few seconds followed by the value of the Weight if it is on the weighing machine selected.

In case of various connected scales, the selected scale is shown on the LCD display of the instrument:

3590E



Selected scale:

1 = scale 1;

2 = scale 2;

R = remote scale

Σ = A+B function

CPWE/CPWET

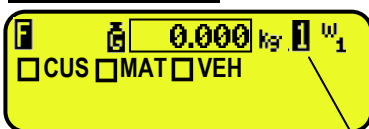

Selected scale:

1 = scale 1;

2 = scale 2;

R = remote scale

Σ = A+B function



5.1 FUNCTIONING WITH REMOTE SCALE

PREMISE: the functioning of the remote scale is foreseen with the use of independent channels (**tYPE** step, **TECH.MAN.REF.**).

The remote scale transmits in a continuous mode the weight string on a dedicated serial port (optional), in a unidirectional (from scale to indicator).

It is possible to use the serial ports on the indicator's motherboard simultaneously with the use of the remote scale.

In the normal scale status, press the **2ndF** and **0** keys to pass to the display of the weight on the remote scale.

If just the remote scale is connected, after the start-up phase, the indicator positions itself directly on it.

If the remote scale allows this, it is possible to carry out the ZERO and TARE operations directly from the indicator.

It is possible to carry out all the weighing procedures described in section 13 (also using the databases), or print the displayed weight.

For the connection refer to the technical manual of the instrument (**TECH.MAN.REF.**).

CONFIGURATION OF THE REMOTE SCALE

See the manual of the remote scale.

CONFIGURATION OF THE INDICATOR

Refer to the technical manual for programming the indicator (**SEtuP** >> **SEriAL** >> **CoMAuX** >> **rEM.SCA** step **TECH.MAN.REF.**).

5.2 "A+B" FUNCTION

"A+B" function allows you to perform weighing operations on each scale or on their **sum**; the function have to be enable in step **F.ModE** >> **totAL** >> **WEi.Mod** >> **nor.WGt** (**TECH.MAN.REF.**).

To display the sum of two scales, press in sequence the **2ndF** and **3** keys, the LCD display shows:

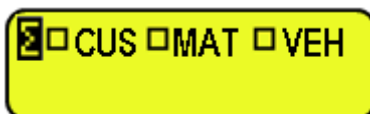

where "Σ" indicates the sum of two scales.

If this function mode is enabled, at the start, the scale shows the sum weight, also if, the views on a single platform, was changed before the turn off of the scale. the print function is the same, so the printer prints the two platforms sum

NOTES

- One can select in every time scale 1 or scale 2 by pressing in sequence **2ndF** and **1** or **2ndF** and **2** keys.
- The total capacity corresponds to the sum of each scale capacity/division.
- the division is the sum divisions, only if the sum is a selectable division in the SETUP environment; otherwise if the result isn't a selectable division, it will be rounded up to the next division. (10+10 = 20, 20+20= 50, 20+10= 50).
- The overload signalling always corresponds to each scale capacity + 9e.
- The function is available for "single vehicle" functioning mode.
- The maximum insertable value of manual tare is always equal to each scale capacity.
- The manual tare is the same for all the scales: the value is shown on LCD display, while display always shows the gross weigh.
- The semiautomatic tare is disabled (on each scale too).
- The 316 function switch the visualization between Preset Tare and the weight values.
- At start-up the indicator places itself on A+B status.

5.3 WEIGHING WITH TWO SCALES: SELECTING INPUT/OUTPUT SCALES

Since it is possible to connect a second scale, in the **F.ModE >> totAL >> i.o.SCA SET INPUT/OUTPUT SCALES** parameter of the TECHNICAL SET-UP (**TECH.MAN.REF.**), one sets how to use the two scales:

- By selecting "SEt.i.o1" one sets the first scale (in other words the one connected to the terminal board or to channel 1) as INPUT, and the second one (in other words the one connected to channel 2) as OUTPUT.
- By selecting "SEt.i.o2" one sets the first scale as INPUT as well as OUTPUT.
- By selecting "FrEE" one can freely use the two scales as: INPUT in the first / OUTPUT in the second, and vice versa, or INPUT/OUTPUT in the first or INPUT/OUTPUT in the second.

6. SCALE ZERO FUNCTION

With various connected scales, select the scale using the numerical keyboard, using the **2ndF** and the **0, 1, 2** and **3** keys.

Keep the **ZERO** key pressed; the message "Zero" appears on the display after which:

- If the weight on the scale is included in the percentage configured in the **<< 0.PErC >> (RIF.MAN.T.)** step, it is zeroed;
- If the weight is not within this range, it will not be cleared and an error sound is emitted.

In the end the indicator automatically returns to the display of the weight present on the scale.

6.1 CYCLICAL AUTOMATIC ZERO

If the cyclical automatic zero has been set at the start-up (in the **SEtuP >> ConFig >> ParaM >> Auto 0** step of the setup, **TECH.MAN.REF.**), by pressing the combination of the **2ndF** and **ZERO** keys, a zero cycle is executed in all the current scales.

7. TARE FUNCTIONS

7.1 SEMIAUTOMATIC TARE

By pressing the **TARE** key one tares any weight which is on the scale; the display shows “**tArE**” for an instant and then 0 (net weight); the **NET** and **→T←**, or **ī**, indicators turn on; the LCD display shows furthermore the stored tare value. Whatever the case, a new operation automatically cancels and substitutes the previous one.

NOTES:

- The automatic tare is acquired only if the weight is of AT LEAST ONE DIVISION AND IS STABLE (⌋ instability led indicator is off) and VALID (In other words the OVERLOAD condition must not be created).
- In the “vehicle with trailer” and in the “A+B” functioning modes, the semiautomatic tare is inhibited.

7.2 PRESET TARE

To enter the tare value, one can do it in several ways:

- 1) With the keyboard type the value (including the decimal point) and press **TARE**.
The **C** key quickly zeros the current value.
- 2) Select a vehicle linked to a tare different than 0.

The indicator automatically subtracts the entered value from the displayed weight, (the **NET** and **→T←**, or **F**, indicators turn on), as long as it is not greater than the instrument’s maximum capacity.

The LCD display shows furthermore the stored tare value, identified with “PT” (Preset Tare).

NOTES

- In the printout, the manual tare is identified with “PT” (Preset Tare).
- In the “vehicle with trailer” and in the “A+B” functioning modes, the display in any case shows the gross weight also in the presence of a manual tare.

7.3 MANUAL CALCULATED TARE

With the “CALCULATOR” function it is possible to add or to subtract to the current tare the result of the operation between two values enterable with the keyboard.

For the functioning specifications see the **15.1 CALCULATOR** section.

7.4 TARE CANCELLATION

To cancel the stored tare:

- With an unloaded platform, press the **TARE** key.
- With loaded platform press in sequence the numeric 0 key and **TARE**.
- Press the **C** key.

7.5 LOCKED/UNLOCKED TARE

Normally, when a tare value has been entered (automatically, manually or from storage) by unloading the scale plate, the display shows the tare value with a negative sign (LOCKED TARE). One can also choose that the tare value is cancelled automatically, each time that the scale is unloaded (UNLOCKED TARE):

CONDITIONS FOR AUTOMATIC UNLOCKING:

- In case of SEMIAUTOMATIC TARE, the net weight before the scale unloading may also be 0.
- In case of MANUAL TARE, CALCULATED TARE or FROM DATABASE, the net weight before the scale unloading must be of at least 2 stable divisions.

By pressing at length the **F5** key it is possible to quickly lock/unlock the tare:

DISPLAY	MEANING
LoCK	LOCKED TARE
unLoCK	UNLOCKED TARE

The setting of the tare may be made also in the "TARE LOCKED/UNLOCKED" **SEtuP >> tArE t** parameter of the TECHNICAL SETUP, **TECH.MAN.REF.**

7.6 LIMITATION OF THE TARE FUNCTIONS

For specific requirements, it is possible to limit the tare functions **with approved instrument**; by setting "YES" in the **SEtuP >> d.SALE** step of the SET-UP environment (**TECH.MAN.REF.**):

- the SEMIAUTOMATIC TARE can not be modified with a manual or calculated tare, or one from database.
- the manual or calculated tare, or one from database must be entered or modified only with UNLOADED scale.

With approved instrument, the **SEtuP >> d.SALE** step is read only.

7.7 TARE EXECUTION MODE OR DISABLING OF THE TARE

It's possible to select the tare execution mode, through the setting of the **F.ModE >> totAL >> tArE** step (**TECH.MAN.REF.**):

- By setting "diSAbL" one disables all the tare operations;
- By setting "Lock" or "Unlock", all the tare operations described in section 7.5 are enabled.

7.8 LINKING A PRESET TARE TO A VEHICLE IN THE DATABASE

It is possible to link a tare value to each article of the vehicle database; this tare value will be enabled with each vehicle selection.

See section 11.3 for further details.

8. MULTIRANGE AND MULTIDIVISION FUNCTION

The **multi range functioning** allows to subdivide the scale capacity in two or three ranges, each which is up to 3000 divisions, improving in this way the first range division in the dual range and the first two ranges in the triple range.

For example it is possible to approve the weighing system with:

- A single range: 6 kg capacity and 2 g division (3000 div.).
- Dual range: 6 / 3 kg capacity and 2/1 g division (3000 + 3000 div.).
- Triple range: 15 / 6 / 3 kg capacity and 5/2/1 g division (3000 + 3000 + 3000 div.).

NOTE: For the approval of the weighing system in dual and triple ranges the cell must have better technical features in comparison to the cell used for the approval in a single range.

This functioning is indicated by the turning on of the indicator which identify the range in which one is working: **W1** first range, **W2** second range, **W3** third range (if configured); by passing to the **W2** range, the second range division is enabled; by passing to the **W3** range, the third range division is enabled, at this point the **W1** first scale division is restored **only by passing the gross zero of the scale**.

The **multidivisional functioning** is similar to multirange, but with the difference that a range division is enabled as soon as one enters in its range interval (in other words **without passing by the scale zero**).

NOTE: The selection of the range number with multirange and multidivisional functioning is made during the indicator calibration (**TECH.MAN.REF.**).

9. DISPLAY OF METRIC DATA (inFO)

The indicator is fitted with a function named "INFO", thanks to which it is possible to view the configuration metric data:

- First range capacity, first range minimum weigh, first range division.
- Second range capacity, second range minimum weigh, second range division.
- Third range capacity, third range minimum weigh, third range division.

NOTES:

- The minimum weigh corresponds to 20 net weight divisions.
- The data of the second and third range appear only if actually configured.

To display the metric data:

- Press in sequence the **2ndF** and **C** key
- "METROLOGIC INFORMATION" is displayed
- The display will show the number of the scale, the type of displayed data and its value.
- Press the **F6** key to quickly scroll the following data
- Press the **F7** key to quickly scroll the previous data backwards.
- Press the **C** key to quickly return to weighing.

10. FILLING IN THE INPUT TEXT

The indicator offers the possibility of using 15 CONFIGURABLE INPUT TEXTS (for example LOT, OPERATOR, SHIFT, etc.), each made up of 16 heading characters and 32 content characters.

When entered in the TECHNICAL SET-UP (see **F.ModE** >> **tXt** "Input text configuration" parameter, **TECH.MAN.REF.**), these may be printed later on, if programmed in the printouts; or these may be used as a reminder.

To manually fill in the input texts it is possible to proceed in two ways:

- 1) **If one knows the memory storage position** (from 0 to 14) of the text to be modified, type the number, followed by the **F4** key: now enter the text and confirm with **ENTER** (the indicator returns to the weighing phase).
- 2) By pressing for an instant the **F4** key, one accesses the complete list of the texts, for example:
 - The LCD display shows "in. XX" in the first line, in which XX is the index of the free text (from 0 to 14) and THE HEADING on the second line (or "Empty..." if empty).
 - Use the arrow **▲ ▼** keys to select the text to be filled in and press **ENTER**: now one can enter the alphanumeric text in the second line of the LCD display, (see chapter 4.1.2 ENTERING ALPHANUMERIC TEXT).
 - Press **ENTER** to store and pass on to the following stored TEXT; by confirming the last entered text one returns automatically to the weigh functioning; it is possible to exit also with the **C** key while in the text selection modification phase.

NOTE:

- The entered texts remain in storage until these are substituted or cancelled.
- If no text has been configured, the pressing of the **F4** key has no effect.
- Through specific print macros, it's possible to automatically cancel the contents of all the texts, right after their printing (**TECH.MAN.REF.**).
- For information on the entry of the alphanumeric texts, see section "4.1.2 ENTERING ALPHANUMERIC TEXT".

10.1 QUICK MODIFICATION OF AN INPUT TEXT

By linking the number of a specific input text to the function **114** (preamble function in the << **F.KEYS** >> step, **TECH.MAN.REF.**), it is possible to access directly to the modification of it with a direct key, for example **F1** key to quickly access the text 0, and **F2** key to quickly access the text 1.

11. DATABASE

11.1 CUSTOMERS

The database is made up of 500 memory storages, identified by an index from 0 to 499, each having three 25-character descriptions; the entry / modification / cancellation of an element **can be protected by a password**; the unlocking procedure is described in section 12.

KEYS	ACCESS	KEY	MENU
	Customer Database Cus.dtb C X	F1 ▶	New
		F2 ▶	Edit
		F3 ▶	Delete
		F4 ▶	Research
		F5 ▶	Print
		Fn ▶	Select
		2nd F ▶	Deselect
		. / HELP ▶	Help

11.1.1 ENTRY

1) Press the **F1** key to access the database.

NOTE: we advise to leave empty the memory storage 0, since it is used for the temporary entry (see section “11.1.6 TEMPORARY ENTRY”).

2) Select the eventual desired position:

- By using the arrow keys ▲ ▼
- With the keyboard by typing the storage number.

3) Press **F1** to enter the customer in the desired position, or in the first empty position if an already occupied position has been selected.

4) One should fill in the following fields (only the necessary ones are requested) by pressing **ENTER** to confirm:

- **"DESCRIPTION 1"**: first description line (up to 30 characters);
- **"DESCRIPTION 2"**: second description line (up to 30 characters);
- **"DESCRIPTION 3"**: third description line (up to 30 characters);

NOTE: the “DESCRIPTION 2” and “DESCRIPTION 3” fields request can be disabled (see F.Mode >> dtb >> En.C.Fld step, TECH.MAN.REF.)

5) Restart from point 2) or press **C** to return to the weighing phase.

11.1.2 MODIFICATION

1) Press the **F1** to access the database.

2) Select the storage to be modified:

- by using the arrow keys ▲ ▼
- by typing the storage number with the keyboard (the LCD display shows the first corresponding DESCRIPTION line)
- by searching the first description (see section 11.1.7)

3) Press **F2**.

4) Select the field to be modified by using the arrow keys ▲ ▼ and press **ENTER**.

5) Modify the value and press **ENTER** to confirm.

6) Restart from point 4) to modify other fields or press **C** to return to the list of storages.

7) Restart from point 2) to modify other storage or press **C** to return to the weighing phase.

11.1.3 CANCELLATION

- 1) Press the **F1** key to access the database.
- 2) Select the storage to be deleted:
 - by using the arrow keys ▲ ▼
 - by typing the storage number with the keyboard (the LCD display shows the first corresponding DESCRIPTION line)
 - by searching the first description (see section 11.1.7)
- 3) Press **F3**.
- 4) The indicator requests a further confirmation: press **ENTER** to confirm or another key to cancel.
- 5) Restart from point 2) or press **C** to return to the weighing phase.

11.1.4 PRINTING

- 1) Press the **F1** to access the database.
- 2) Press the **F5** key: the LCD display shows "PRINT?". Confirm with **ENTER** or press another key to cancel. here one is given suggestions on how to print the list of the memory storages:
 - By pressing the **0** key **all the memory storages in the database** are printed, each with:
MEMORY NR.
DESCRIPTION1
DESCRIPTION2
DESCRIPTION3
 - By pressing the **1** key, **just the memories which have been handled** will be printed, each with:
MEMORY NR.
DESCRIPTION1
DESCRIPTION2
DESCRIPTION3

TOTAL INPUT WEIGHT = net weight of the quantity which has entered in the factory (in other words the sum of the net weights greater than zero [so with the input weight greater than the output weight], **of all the pairs and of the single weighs carried out**).

TOTAL OUTPUT WEIGHT = net weight of the quantity which has left the factory (in other words the sum of the net weights less than zero [so with the input weight less than the output weight], **of all the pairs and of the single weighs carried out**).

NET TOTAL = the net of all transactions (TOTAL OUTPUT WEIGHT minus the TOTAL INPUT WEIGHT).

WEIGHS TOTAL = number of weigh pairs (input weigh with relative output weigh) and of all the single weighs carried out.
- 3) Restart from point 2) or press **C** to return to the weighing phase.

11.1.5 SELECTION / DESELECTION

With no memory storage selected, the LCD display shows in the data section

(see 4.2 section **CUS MAT VEH**):

To **SELECT** the memory storage, one can proceed in two ways:

- 1) Type the memory storage number and press **F1**.
- 2) Press the **F1** to access the database.
Select the memory storage:
 - by using the arrow keys ▲ ▼
 - by typing the storage number with the keyboard (the LCD display shows the first corresponding DESCRIPTION line)
 - by searching the first description (see section 11.1.7)
 Press **ENTER**.

In both cases, the LCD display shows in the data section

(see 4.2 section **CUS MAT VEH**):

At this point the memory storage will be linked to the weigh under way and will be printed if foreseen in the ticket.

To **DESELECT** the memory storage, one can proceed in two ways:

- 1) Press the **F1** key to access the database.
Press **2nd F**, the LCD display shows:

**DESELECT
CUSTOMER?**

Press **ENTER** to confirm or another key to cancel.

- 2) Press in sequence the **2nd F** and **F4** keys to deselect **ALSO THE MATERIAL AND THE VEHICLE**.
The LCD display shows:

**DESELECT
ALL THE ITEMS?**

Press **ENTER** to confirm or another key to cancel.

NOTE: Through specific print macros, it's possible to **deselect automatically the memory storage**, right after the printing (**TECH.MAN.REF.**).

11.1.6 ENTRY, MODIFICATION AND QUICK SELECTION OF CUSTOMER 000

It's possible to directly enter a temporary memory storage in order to avoid the filling in of the database:

- 1) Press in sequence the **0** (NUMERIC) and **F1**.
- 2) The indicator allows directly filling in the memory storage 000; seeing section "11.1.1 ENTRY" for the data to be filled in.
- 3) Upon confirmation with **ENTER** of the last data, the memory storage will automatically be selected.

NOTES

- Upon each temporary entry, the 000 memory storage will be overwritten.
- By executing an output weigh, **the last temporary entry made will always** be printed.

11.1.7 ALPHABETICAL RESEARCH

The access to the ALPHABETICAL RESEARCH is possible in the following 2 ways:

- 1) by pressing the **F1** to access the database and by pressing the **F4** key;
or
- 2) through function **312** combinable with the desired key (<< **F.KEYS** >> step, **TECH.MAN.REF.**).

To search a customer:

- 1) Enter the desired characters to be searched in the first description of all the customers.
- 2) Select the desired storage in the list of the result by using the arrow keys **▲ ▼** and press **ENTER**.
- 3) Carry out one of the operation described in the previous sections.

11.1.8 HELP

By pressing the **./HELP** key, it's possible to see the keys list used in the menu.

The key list scrolls automatically. If you want to see the keys list, in manual mode, use the arrow key (**F6 ▼** and **F7 ▲**).

11.2 MATERIALS

The database is made up of 500 memory storages, identified by an index from 0 to 499, each having two 20-character descriptions; the entry / modification / cancellation of an element **can be protected by a password**; the unlocking procedure is described in section 12.

KEYS	ACCESS	KEY	MENU
	Material Database Mat.dtb M X	F1 ▶	New
		F2 ▶	Edit
		F3 ▶	Delete
		F4 ▶	Research
		F5 ▶	Print
		Fn ▶	Select
		2nd F ▶	Deselect
		. / HELP ▶	Help

11.2.1 ENTRY

- 1) Press the **F2** key to access the database.
NOTE: it is advisable to leave empty the 0 memory storage, since it is used for the temporary entry (see section "11.2.6 TEMPORARY ENTRY").
- 2) Select the eventual desired position
 - By using the arrow keys ▲ ▼
 - with the keyboard by typing the storage number.
- 3) Press **F1** to insert the material in the desired position, or with the first free position, if an already occupied position has been selected.
- 4) One should fill in the following fields (only the necessary ones are requested); press **ENTER** to confirm:
 - "**DESCRIPTION 1**": first description line (up to 20 characters);
 - "**DESCRIPTION 2**": second description line (up to 20 characters);**NOTE: the "DESCRIPTION 2" field request can be disabled (see F.ModE >> dtb >> En.M.FLd step, RIF.MAN.T.).**
- 5) Restart from point 2) or press **C** to return to the weighing phase.

11.2.2 MODIFICATION

- 1) Press the **F2** key to access the database.
- 2) Select the storage to be modified:
 - by using the arrow keys ▲ ▼
 - by typing the storage number with the keyboard (the LCD display shows the first corresponding DESCRIPTION line)
 - by searching the first description (see section 11.2.7)
- 3) Press **F2**.
- 4) Select the field to be modified by using the arrow keys ▲ ▼ and press **ENTER**.
- 5) Modify the value and press **ENTER** to confirm.
- 6) Restart from point 4) to modify other fields or press **C** to return to the list of storages.
- 7) Restart from point 2) to modify other storage or press **C** to return to the weighing phase.

11.2.3 CANCELLATION

- 1) Press the **F2** key to access the database.
- 2) Select the storage to be modified:
 - by using the arrow keys ▲ ▼
 - by typing the storage number with the keyboard (the LCD display shows the first corresponding DESCRIPTION line)
 - by searching the first description (see section 11.2.7)
- 3) Press **F3**.
- 4) The indicator requests a further confirmation: press **ENTER** to confirm or another key to cancel.
- 5) Restart from point 2) or press **C** to return to weighing.

11.2.4 PRINTING

- 1) Press the **F2** key to access the database.
- 2) Press the **F5** key: the LCD display shows "PRINT?". Confirm with **ENTER** or press another key to cancel. Here one is given suggestions on how to print the list of the memory storages:
 - By pressing the **0** key **all the memory storages in the database** are printed, each with:
MEMORY NR.
DESCRIPTION1
DESCRIPTION2
 - By pressing the **1** key, **just the memories which have been handled** will be printed, each with:
MEMORY NR.
DESCRIPTION1
DESCRIPTION2
TOTAL INPUT WEIGHT = net weight of the quantity which has entered in the factory (in other words the sum of the net weights greater than zero [so with the input weight greater than the output weight], **of all the pairs and of the single weighs carried out**).
TOTAL OUTPUT WEIGHT = net weight of the quantity which has left the factory (in other words the sum of the net weights less than zero [so with the input weight less than the output weight], **of all the pairs and of the single weighs carried out**).
NET TOTAL = the net of all transactions (TOTAL OUTPUT WEIGHT minus the TOTAL INPUT WEIGHT).
WEIGHS TOTAL = number of weigh pairs (input weigh with relative output weigh) and of all the single weighs carried out.
- 3) Restart from point 2) or press **C** to return to weighing.

11.2.5 SELECTION / DESELECTION

With no memory storage selected, the LCD display shows in the data section

(see 4.2 section **☐ CUS ☐ MAT ☐ VEH**):

One can **SELECT** the memory storage in two ways:

- 1) Type the memory storage number and press **F2**.
- 2) Press the **F2** key to access the database.
Select the memory storage:
 - by using the arrow keys ▲ ▼
 - by typing the storage number with the keyboard (the LCD display shows the first corresponding DESCRIPTION line)
 - by searching the first description (see section 11.2.7)
 Press **ENTER**.

In both cases, the LCD display shows in the data section (see 4.2 section **☐ CUS ☑ MAT ☐ VEH**):

At this point the memory storage will be linked to the weigh under way and will be printed if foreseen in the ticket.

To **DESELECT** the memory storage, one may proceed in two ways:

- 1) Press the **F2** key to access the database.
Press **2nd F**, the LCD display shows:

**DESELECT
MATERIAL?**

Press **ENTER** to confirm or another key to cancel.

- 2) Press in sequence the **2nd F** and **F4** keys to deselect **ALSO THE CUSTOMER AND THE VEHICLE**.
The LCD display shows:

**DESELECT
ALL THE ITEMS?**

Press **ENTER** to confirm or another key to cancel.

NOTE: Through specific print macros, it's possible to **automatically deselect the memory storage**, right after its printout (**TECH.MAN.REF.**).

11.2.6 ENTRY, MODIFICATION AND QUICK SELECTION OF MATERIAL 000

It's possible to directly enter a temporary memory storage in order to avoid the filling in of the database:

- 1) Press in sequence the **0** (NUMERIC) and **F2** keys.
- 2) The indicator allows directly filling in the memory storage 000; seeing section "11.2.1 ENTRY" for the data to be filled in.
- 3) Upon confirmation with **ENTER** of the last data, the memory storage will automatically be selected.

NOTES

- Upon each temporary entry, the 000 memory storage will be overwritten.
- By executing an output weigh, **the last temporary entry made will always** be printed.

11.2.7 ALPHABETICAL RESEARCH

The access to the ALPHABETICAL RESEARCH is possible in the following 2 ways:

- 1) by pressing the **F2** to access the database and by pressing the **F4** key;
or
- 2) through function **313** combinable with the desired key (<< **F.KEYS** >> step, **TECH.MAN.REF.**).

To search a material:

- 1) Enter the desired characters to be searched in the first description of all the materials.
- 2) Select the desired storage in the list of the result by using the arrow keys **▲ ▼** and press **ENTER**.
- 3) Carry out one of the operation described in the previous sections.

11.2.8 HELP

By pressing the **./HELP** key, it's possible to see the keys list used in the menu.

The key list is automatically. If you want to see the keys list, in manual mode, use the arrow key (**F6 ▼ e F7 ▲**).

11.3 VEHICLES

The database is made up of 500 memory storages, identified by an index from 0 to 499, each having a license plate of 10 characters, one 20-character description and a tare value; the entry / modification / cancellation of an element **can be protected by a password**; the unlocking procedure is described in section 12.

KEYS	ACCESS	KEY	MENU
	Vehicle Database Veh.dtb V X	F1 ▶	New
		F2 ▶	Edit
		F3 ▶	Delete
		F4 ▶	Research
		F5 ▶	Print
		Fn ▶	Select
		2nd F ▶	Deselect
		. / HELP ▶	Help

11.3.1 ENTRY

- 1) Press the **F3** key to access the database.
NOTE: it is advisable to leave empty the 0 memory storage, since it is used for the temporary entry (see section "11.3.6 TEMPORARY ENTRY").
- 2) Select the eventual desired position using the arrow keys ▲ ▼ (or with the keyboard type the position number).
- 3) Press **F1** to insert the vehicle in the desired position, or with the first free position, if an already occupied position has been selected.
- 4) One should fill in the following fields (only the necessary ones are requested); press **ENTER** to confirm:
 - **"PLATE"**: plate value (up to 10 characters);
 - **"DESCRIPTION"**: description line (up to 20 characters);
 - **"TARE"**: tare value**NOTE: the "DESCRIPTION" and "TARE" fields request can be disabled (see F.ModE >> dtb >> En.V.Fld step, TECH.MAN.REF.).**
- 5) Restart from point 2) or press **C** to return to weighing.

11.3.2 MODIFICATION

- 1) Press the **F3** to access the database.
- 2) Select the storage to be modified:
 - by using the arrow keys ▲ ▼
 - by typing the storage number with the keyboard (the LCD display shows the first corresponding PLATE line)
 - by searching the plate (see section 11.3.7)
- 3) Press **F2**.
- 4) Select the field to be modified by using the arrow keys ▲ ▼ and press **ENTER**.
- 5) Modify the value and press **ENTER** to confirm.
- 6) Restart from point 4) to modify other fields or press **C** to return to the list of storages.
- 7) Restart from point 2) to modify other storage or press **C** to return to the weighing phase.

11.3.3 CANCELLATION

- 1) Press the **F3** key to access the database.
- 2) Select the storage to be modified:
 - by using the arrow keys ▲ ▼
 - by typing the storage number with the keyboard (the LCD display shows the first corresponding PLATE line)
 - by searching the plate (see section 11.3.7)
- 3) Press **F3**.
- 4) The indicator requests a further confirmation: press **ENTER** to confirm or another key to cancel.
- 5) Restart from point 2) or press **C** to return to weighing.

11.3.4 PRINTING

- 1) Press the **F3** key to access the database.
- 2) Press the **F5** key: the LCD display shows "PRINT?". Confirm with **ENTER** or press another key to cancel. Here one is given suggestions on how to print the list of the memory storages:
 - By pressing the **0** key **all the memory storages in the database** are printed, each with:
 - MEMORY NR.
 - PLATE
 - DESCRIPTION
 - TARE
 - By pressing the **1** key, **just the memories which have been handled** will be printed, each with:
 - MEMORY NR.
 - PLATE
 - DESCRIPTION
 - TARE
 - TOTAL INPUT WEIGHT = net weight of the quantity which has entered in the factory (in other words the sum of the net weights greater than zero [so with the input weight greater than the output weight], **of all the pairs and of the single weighs carried out**).
 - TOTAL OUTPUT WEIGHT = net weight of the quantity which has left the factory (in other words the sum of the net weights less than zero [so with the input weight less than the output weight], **of all the pairs and of the single weighs carried out**).
 - NET TOTAL = the net of all transactions (TOTAL OUTPUT WEIGHT minus the TOTAL INPUT WEIGHT).
 - WEIGHS TOTAL = number of weigh pairs (input weigh with relative output weigh) and of all the single weighs carried out.
- 3) Restart from point 2) or press **C** to return to weighing.

11.3.5 SELECTION / DESELECTION

With no memory storage selected, the LCD display shows in the data section

(see 4.2 section **CUS MAT VEH**):

To **SELECT** the memory storage, one can proceed in two ways:

- 1) Type the memory storage number and press **F3**.
- 2) Press the **F3** key to access the database.
 - Select the memory storage:
 - by using the arrow keys ▲ ▼
 - by typing the storage number with the keyboard (the LCD display shows the first corresponding PLATE line)
 - by searching the plate (see section 11.3.7)
 - Press **ENTER**.

In both cases, the LCD display shows in the data section

(see 4.2 section **CUS MAT VEH**):

At this point the memory storage will be linked to the weigh under way and will be printed if foreseen in the ticket. To **DESELECT** the memory storage, one can proceed in two ways:

- 1) Press the **F3** key to access the database.
Press **2nd F**, the LCD display shows:

**DESELECT
VEHICLE?**

Press **ENTER** to confirm or another key to cancel.

- 2) Press in sequence the **2nd F** and **F4** keys to deselect **ALSO THE CUSTOMER AND THE MATERIAL**.
The LCD display shows:

**DESELECT
ALL THE ITEMS?**

Press **ENTER** to confirm or another key to cancel.

NOTES:

- Through specific print macros, it's possible to **automatically deselect the memory storage**, right after its printout (**TECH.MAN.REF.**).
- The deselection of the vehicle cancels also the possible linked tare.

11.3.6 ENTRY, MODIFICATION AND QUICK SELECTION OF VEIHCLE 000

It's possible to directly enter a temporary memory storage in order to avoid the filling in of the database:

- 1) Press in sequence the **0** (NUMERIC) and **F3** keys.
- 2) The indicator allows directly filling in the memory storage 000; seeing section 11.3.1 "ENTRY" for the data to be filled in.
- 3) Upon confirmation with **ENTER** of the last data, the memory storage will automatically be selected.

NOTES

- Upon each temporary entry, the 000 memory storage will be overwritten.
- By executing an output weigh, **the last temporary entry made will always** be printed.

11.3.7 ALPHABETICAL RESEARCH

The access to the ALPHABETICAL RESEARCH is possible in the following 2 ways:

- 1) by pressing the **F3** to access the database and by pressing the **F4** key;
or
- 2) through function **314** combinable with the desired key (<< **F.KEYS** >> step, **TECH.MAN.REF.**).

To search a vehicle:

- 1) Enter the desired characters to be searched in the plate of all the vehicles.
- 2) Select the desired storage in the list of the result by using the arrow keys **▲ ▼** and press **ENTER**.
- 3) Carry out one of the operation described in the previous sections.

11.3.8 HELP

By pressing the **./HELP** key, it's possible to see the keys list used in the menu.

The key list is automatically. If you want to see the keys list, in manual mode, use the arrow key (**F6 ▼ e F7 ▲**).

12. DATABASE ACCESS PASSWORD

In the SETUP (F. ModE >> dtb.PWd parameter, TECH.MAN.REF.) one can set a password for access to the databases. A password will be required only when one wants to insert, modify or delete an element of the file; for a moment the LCD display shows the message “uSEr”; afterwards, it will be no longer possible to make changes to the database.

To access the complete menu

- Press any key DURING THE VISUALISATION OF THE “uSEr”: the instrument requests the entry of the password (a number will appear).
- Enter the password and confirm with ENTER.

13. WEIGHING PROCEDURES

13.1 GENERAL DESCRIPTION OF THE SYSTEM

Besides the basic standard weighing function, this 3590E-AF03 version allows to keep under control the flow of goods in input and output from a warehouse or a factory, with the possibility of simultaneously managing up to 999 vehicles, also on two scales; these vehicles can be managed as single vehicles or as vehicles with trailer.

To guarantee correlation between the two operations, the system foresees two identification methods: through ID code or through the LICENSE PLATE of the vehicle.

The implementation of external modules like the PC keyboard, the bar code or badge readers, allows to quicken the weighing operations; furthermore through the “MASTER - SLAVE” function it’s possible to manage the weighing system also from a second remote indicator.

Furthermore, the programme has been made to manage the accumulation and the printing of the of the weight difference.

The weight difference is automatically accumulated in the instrument totals (PARTIAL, GENERAL, GRAND TOTAL), and the weighs’ progressives are automatically increased relative to the previously shown totals.

Furthermore, if a customer/material/vehicle has been enabled, the instrument increases both the totals as well as the weighs’ progressive relative to the selected article.

13.2 WEIGHING THROUGH ID CODE

NOTE: the functioning mode must be enabled: set F.ModE >> totAL >> WEi.MEM step of the SETUP environment on “WEi.Cod” (TECH.MAN.REF.).

In this functioning mode, the indicator links each input weigh **to the lowest available ID** (from 1 to 999); consequently, if an output weigh is executed correctly, the relative ID code will be made available for the following input weigh.

It’s possible to have the ID code of the input weigh to be **always consequential** (therefore also if an ID lower than the last one stored is available) by setting the F.ModE >> totAL >> Pro.LSt step in the set-up on “DISABLE”, TECH.MAN.REF.

13.2.1 INPUT WEIGH

13.2.1.1 Single vehicle

(F.ModE >> totAL >> WEi.Mod step set on “nor.WGt”, TECH.MAN.REF.)

- Position the vehicle on the scale.
- Select, if requested, the customer / material / vehicle to be linked to the weigh.
- Press the **F6** key, the LCD display will show:

ENTRY WEIGH

READING WEIGHT

- The indicator executes the printout (if configured), and then it displays the weight on the scale.

13.2.1.2 Vehicle with trailer

(F.ModE >> totAL >> WEi.Mod step set on "SEC.WGt", TECH.MAN.REF.)

- Position the vehicle on the scale.
- Select, if requested, the customer / material / vehicle to be linked to the weigh.
- Press the F6 key, the LCD display will show:

ENTRY WEIGH

READING WEIGHT

SECOND WEIGH?
ENTER=YES C=NO

Or, if one has configured TWO SCALES:

SECOND WEIGH? C=NO
1=SCL.1 2=SCL.2

At this point one should position the trailer on the scale, wait a few instants for the weight stability.

By pressing **ENTER** it is possible to:

- **CONFIRM THE SAME PLATFORM** If the **F.Mode >> totAL >> C.EntEr** parameter of the setup is set on "ConFEr" (CONFIRM SCALE), **TECH.MAN.REF.**
- **CHANGE PLATFORM:** If the **F.Mode >> totAL >> C.EntEr** parameter of the setup is set on "inVEr" (INVERT SCALE), **TECH.MAN.REF.**

Note: It is in any case possible to change the platform by pressing the **1** key for platform 1 or the **2** key for platform 2.

In the printout, the trailer weight will be shown on the side ("TRAILER" item), right after the trailer weight ("INPUT" item). By pressing **C** the weigh will be carried out anyways, but only the trailer weight will be taken into consideration and printed ("INPUT" item).

NOTES ON INPUT WEIGHING

- If there is a tare, a **SINGLE WEIGH** is executed, therefore **no ID code is occupied**.
- If all the 999 memory storages are occupied without executing any output weigh, upon the execution of the following input weigh, the indicator shows the message "WEIGHS MEMORY FINISHED"; one must execute at least one output weigh in order to free up the memory to be used.

To cancel all the memory storages, is necessary to use the 426 function (digit the number and press ENTER).

If one needs to execute a simple weigh without any input/output weigh and databases, we advise to use the print key, in order to not occupy ID codes.

- If the output weigh has been made with a selected vehicle, one should execute the output weigh in order to reuse the same vehicle in a new weigh (the LCD display shows "PLATE ALREADY PRESENT!").

13.2.2 OUTPUT WEIGH

13.2.2.1 Single vehicle

(F.ModE >> totAL >> WEi.Mod step set on “nor.WGt”, TECH.MAN.REF.)

- Position the vehicle on the scale.
- Select, if requested, the customer / material / vehicle to be linked to the weigh.
- Now it's possible to proceed in two ways:

1) Directly type in the ID code and press F7.

2) Press F7: one enters the menu of the “open” input weighs:

ID:	1
IN:	995kg

Select the desired weigh using the arrow keys ▲ ▼ .
Confirm with **ENTER** or press **C** to exit.

- In both cases, the indicator executes the printout (if configured), and then displays the weight on the scale.

13.2.2.2 Vehicle with trailer

(F.ModE >> totAL >> WEi.Mod step set on “SEC.WGt”, TECH.MAN.REF.)

- Proceed the same way with the weigh of the single vehicle (see previous paragraph).
- The LCD display will show:

SECOND WEIGH?	
ENTER=	YES
C=	NO

Or, if one has configured TWO SCALES:

SECOND WEIGH? C=NO	
1=SCL.1	2=SCL.2

At this point one should position the trailer on the scale, wait a few instants for the weight stability.

By pressing **ENTER** it is possible to:

- **CONFIRM THE SAME** If in the F.ModE >> totAL >> C.EntEr parameter of the setup one sets **PLATFORM** “ConFEr” (CONFIRM SCALE), TECH.MAN.REF.
- **CHANGE PLATFORM:** If in the F.ModE >> totAL >> C.EntEr parameter of the setup one sets “inVErt” (INVERT SCALE), TECH.MAN.REF.

Note: It is in any case possible to change the platform by pressing the **1** key for platform 1 or the **2** key for platform 2. In the printout, the trailer weight will be shown separately (“TRAILER” item), right below the tractor weight (“OUTPUT” item). By pressing **C** the weigh is cancelled and the indicator returns to the weighing mode (“OUTPUT” item).

NOTES ON THE OUTPUT WEIGH

- If there is a tare, a **SINGLE WEIGH** is executed.
- **By entering an ID code not yet linked to a weigh**, the indicator shows on the LCD display “MEMORY IS EMPTY” and emits a prolonged sound; then it cancels the weigh and returns to weighing.
- **By entering the ID code of an already executed weigh**, the LCD display will show:

**WEIGH ALREADY
DONE, CONTINUE?**

Confirm with **ENTER** or press another key to cancel.

- If no input weigh has been made, if one then enters the menu of the “open” weighs, the indicator will show on the LCD display “NO OPEN WEIGHS IN INPUT” and will emit a prolonged sound; then it will cancel the weigh and return to weighing.

13.3 WEIGHING THROUGH VEHICLE LICENSE PLATE

NOTE: the functioning mode must be enabled: set **F.ModE >> totAL >> WEi.MEM** step of the SETUP environment on “**PLAtE**” (**TECH.MAN.REF.**).

In this functioning mode, the indicator links the selected plate (through the vehicle) to the input weigh.

13.3.1 INPUT WEIGH

13.3.1.1 Single vehicle

(**F.ModE >> totAL >> WEi.Mod** step of the setup set on “**nor.WGt**”, **TECH.MAN.REF.**)

The procedure is the same as the weighing through ID code (see section 13.2.1.1).

13.3.1.2 Vehicle with trailer

(**F.ModE >> totAL >> WEi.Mod** step of the setup set on “**SEC.WGt**”, **TECH.MAN.REF.**)

The procedure is the same as the weighing through ID code (see section 13.2.1.2).

NOTES ON INPUT WEIGHING

- One must select a vehicle, otherwise the indicator will show on the LCD display “PLATE NOT PRESENT” and will emit a prolonged sound; then it cancels the weigh and returns to weighing.
- If there is a tare, a **SINGLE WEIGH** is executed.
- If one executes 999 weighs without executing any output weigh, when one executes the following input weigh, the indicator will display the message “WEIGHS MEMORY EMPTY”; one should execute at least one output weigh in order to free up the memory storage to be used.

To cancel all the memory storages, go to the **Prn.ViS >>> 0.W.List** step in the menu of the **ENTER** key.

If one needs to make a simple weigh without any input/output and databases, it is advisable to use the print key, in order to not occupy the memory storages.

- If one executes the input weigh with a selected vehicle, one should execute the output weigh, in order to reuse the same vehicle in a new weigh (the LCD display shows “PLATE ALREADY PRESENT!”).

13.3.2 OUTPUT WEIGHING

13.3.2.1 Single vehicle

(F.ModE >> totAL >> WEi.Mod step of the setup set on “nor.WGt”, TECH.MAN.REF.)

- Position the vehicle on the scale.
- Select, if requested, the customer / material to be linked to the weigh.
- Now it's possible to proceed in two ways:

Press F7, the LCD display will show:

INSERT
PLATE

—

Enter the license plate number and press ENTER.

1) Press F7, the LCD display will show:

INSERT
PLATE

—

Press ENTER, one enters the menu of the “open” input weighs:

CM884FK
IN: 995kg

Select the desired weigh using the arrow keys ▲ ▼ .
Confirm with ENTER or press C to exit.

- In both cases, the indicator executes the printout (if configured) and then displays the weight on the scale.

13.3.2.2 Vehicle with trailer

(F.ModE >> totAL >> WEi.Mod step of the setup set on “SEC.WGt”, TECH.MAN.REF.)

- Proceed the same way as with the weigh of the single vehicle (see previous section).
- The LCD display will show:

SECOND WEIGH?
ENTER=YES C=NO

Or, if one has configured TWO SCALES:

SECOND WEIGH? C=NO
1=SCL.1 2=SCL.2

At this point one should position the trailer on the scale, wait a few instants for the weight stability.
By pressing ENTER it is possible to:

- **CONFIRM THE SAME PLATFORM** If in the F.Mode >> totAL >> C.EntEr parameter of the setup one has set “ConFER” (CONFIRM SCALE), TECH.MAN.REF.

- **CHANGE PLATFORM** If in the **F.Mode >> totAL >> C.EntEr** parameter of the setup one has set “inVErt” (INVERT SCALE), **TECH.MAN.REF.**

Note: It is in any case possible to change the platform by pressing the **1** key for platform **1** or the **2** key for platform **2**.

In the printout, the trailer weight will be shown separately (“TRAILER” item), right below the tractor weight (“OUTPUT” item). By pressing **C** the weigh is cancelled and the indicator returns to the weighing mode (“OUTPUT” item).

NOTES ON THE OUTPUT WEIGH

- If there is a tare, a **SINGLE WEIGH** is executed.
- **By entering an incorrect license plate or not linked to a weigh**, the indicator will show on the LCD display “PLATE NOT PRESENT” emitting a prolonged sound; then it will cancel the weigh and return to weighing.
- **By entering the plate of an already executed weigh**, the LCD display will show:

**WEIGH ALREADY
DONE, CONTINUE?**

Confirm with **ENTER** or press another key to cancel.

- If no input weigh has been made, if one then enters the menu of the “open” weighs, the indicator will show on the LCD display “NO OPEN WEIGHS IN INPUT” and will emit a prolonged sound; then it will cancel the weigh and return to weighing.

13.4 CONDITIONS FOR TOTALISATION

With APPROVED instrument:

- the INPUT or OUTPUT weigh functions with a minimum weight of 20 divisions and reactivates according to how the **F.ModE >> rEAct.** “REACTIVATIONS” parameter of the TECHNICAL SET-UP has been programmed (**RIF.MAN.T.**), in other words the weight movement or passage by zero of the weight; furthermore the **F6** key excludes the **F7** and the printout keys and vice versa.
- the totalisation excludes the simple print function and vice versa.

With NON APPROVED instrument:

- the INPUT or OUTPUT weigh functions with a weight greater than zero and reactivates according to how the **F.ModE >> rEAct.** “REACTIVATIONS” parameter of the TECHNICAL SET-UP (TECH.MAN.REF.) has been programmed; furthermore the **F6** key excludes the **F7** key and vice versa.
- the totalisation does not exclude the simple print function.

13.5 ADDITIONAL TARE FUNCTION

This function is useful if one wants to calculate the loaded/unloaded weight at the net of a tare added to the weight of the vehicle taken into consideration.

By enabling the function in the **F.ModE >> totAL >> Add.tAr** step, it's possible to have that, upon the output weigh, one is asked to enter an additional tare, which will be subtracted from the loaded/unloaded weight value in the weigh.

After the pressing of the **F7** key and the selection of the “open” weigh in input, one enters the calculator environment (the LCD display shows the message “ADDITIONAL TARE”).

Procedure:

With the numerical keyboard enter the first value then

- Press **Fn** in order to consider this value as an additional tare

or

- Press **F1** to add, **F2** to multiply, **F3** to subtract:
 - With the numeric keyboard enter the second value of the operation.
 - **PRESS ENTER:** the result will be shown for a few seconds on the display.

The printing of the “CALCULATOR” print function will not be made, but one proceeds with the printing of the output weigh.

The result of the additional tare is automatically subtracted from the loaded or unloaded weight.

13.6 TOLERANCE WEIGHING FIELD

It is possible to establish a weight interval (in between 0 and the scale capacity) for executing an input or output weigh; outside this interval, the operation is not accepted (when the **F6** or **F7** key is pressed the LCD display shows the "WEIGHT OUT OF THRESHOLD" message for a few seconds).

SETTING OF WEIGHT THRESHOLD:

- Through the **500** function, combinable with the desired key (<< **F.KEYS** >> step, **TECH.MAN.REF.**), it's possible to access the "thr.hi" menu (Maximum Threshold Setting): set the upper totalisation threshold and press **ENTER**.
- Through the **501** function, combinable with the desired key (<< **F.KEYS** >> step, **TECH.MAN.REF.**), it's possible to access the "thr.Lo" menu (Minimum Threshold Setting): set the lower totalisation threshold and press **ENTER**.

NOTES:

- By setting 0 in the maximum threshold, it's possible to totalise up to the maximum capacity of the scale.
- By setting 0 in both thresholds, the functions are disabled.
- The totalisation field is valid for all totalisation types (input/output and single weigh).

13.7 REENABLING THE PRINTING AND INPUT / OUTPUT WEIGH

After having carried out an input/output weigh or a single weigh, in order to carry out a new one, the displayed weight must pass by the zero or become unstable.

This setting is made in the SETUP environment, in the **F.ModE >> rEAct.** parameter (**TECH.MAN.REF.**).

While using the indicator, one may incur in the "WEIGHT NOT PASSED BY 0 OR UNSTAB." error shown on the LCD display, this means that the function which one wants to carry out, must be reenabled (in order to avoid accidental executions).

In any case, one can also exclude this type of check: in order to do this, one should set "ALWAYS" in the **F.ModE >> totAL >> t.ModE** step (**TECH.MAN.REF.**)

13.8 VISUALISATION AND CLEARING OF THE ACCUMULATED TOTALS

Each total can be momentarily viewed on the display or cleared independently through the printout, linking the corresponding function to the desired key (<< **F.KEYS** >> step, **TECH.MAN.REF.**):

TOTAL	FUNCTION CODE FOR VISUALISATION	FUNCTION CODE FOR RESETTING
PARTIAL TOTAL	416	418
GENERAL TOTAL	419	421
GRAND TOTAL	422	424
CUSTOMER TOTAL	404	406
MATERIAL TOTAL	408	410
VEHICLE TOTAL	412	414
ALL CUSTOMERS TOTAL	-	407
ALL MATERIALS TOTAL	-	411
ALL VEHICLES TOTAL	-	415
ALL SCALE TOTAL (partial total, general total, grand total)	-	425
LIST SAMPLES	-	426

By recalling one of the clearing functions, the instrument requests a confirmation before proceeding with the cancellation: press **ENTER** to clear, **C** for continuing to accumulate.

It's possible to disable the confirmation request, in the **F.ModE >> totAL >> rESEt** step, **TECH.MAN.REF.**

In case of visualisation of the total, the instrument automatically exits the function after a few seconds.

NOTES:

- The weight data of the cleared total will be updated only with the subsequent input/output weigh or single weigh.
- The ARTICLE TOTAL is article specific, in other words, there is a total for EACH ARTICLE USED. The other totals are GENERIC, and can be cleared INDEPENDENTLY ONE FROM THE OTHER (i.e. if one clears the Grand total, with the following input/output weigh, the other totals will continue to increment, while the Grand total will restart from 0).
- By clearing the weighs' list one obtains the clearing of all the "open" input weighs: By carrying out this operation all the weighing operations under way are cancelled.

13.9 PROGRESSIVES**13.9.1 PROGRESSIVE DIGITS**

Through function **401**, combinable with the desired key (<< **F.KEYS** >> step, **TECH.MAN.REF.**), it's possible to set the number of digits with which the TICKET PROGRESSIVE and LOT PROGRESSIVE are printed.

The number of settable digits varies from 4 to 16, organised in this way:

- if the actual digits of the total are less than the number of digits set in this step, the difference is filled with some spaces.
- if the actual digits are greater than the number of digits set in this step, only the ones actually entered are taken into consideration (counting from right to left).

The alignment of the total fields is on the left.

NOTE: The number of settable digits DOES NOT INCLUDE the comma.

13.9.2 TICKET PROGRESSIVE

Through function **402**, combinable with the desired key (<< **F.KEYS** >> step, **TECH.MAN.REF.**), it's possible to modify or clear the TICKET PROGRESSIVE (up to 5 digits).

The TICKET PROGRESSIVE is a progressive number which increments of one UPON THE FIRST TOTALISATION SUBSEQUENT TO THE CLEARING OF THE PARTIAL TOTAL.

13.9.3 LOT PROGRESSIVE

Through function **403**, combinable with the desired key (<< **F.KEYS** >> step, **TECH.MAN.REF.**), one obtains the clearing of the AUTOMATIC LOT (up to 6 digits); before carrying out the actual clearing, one is asked to confirm or cancel the operation; confirm with **ENTER**.

The AUTOMATIC LOT is a progressive number which increments of one UPON THE FIRST TOTALISATION SUBSEQUENT TO THE CLEARING OF THE GENERAL TOTAL..

14. SELF-SERVICE

14.1 SELF SERVICE SYSTEM

AUTOMATIC INPUT/OUTPUT

If the automatic input/output step is ENABLED **F.ModE >> totAL >> A.inout (TECH.MAN.REF.)** when you enter in weighing mode is necessary to proceed in this way:

- Load the weight on the scale;
- Select the vehicle in the vehicle database;
- Once you have selected the vehicle, the indicator makes automatically the input weighing and prints;
- Remove the weight from the scale and pass by zero (the vehicle is deselected automatically);
- Load again the weight on the scale;
- Select again the vehicle in the vehicle database;
- The indicator makes automatically the output weighing and prints

SIMPLE PRINTOUT

If the automatic input/output step is SIMPLE PRINTOUT **F.ModE >> totAL >> A.inout (TECH.MAN.REF.)** when you enter in weighing mode is necessary to proceed in this way:

- Load the weight on the scale;
- Select the vehicle in the vehicle database;
- The indicator makes automatically the simple printout.

14.2 SELF SERVICE SYSTEM WITH BADGE READER OR RFID

AUTOMATIC INPUT/OUTPUT

If the automatic input/output step is ENABLED **F.ModE >> totAL >> A.inout (TECH.MAN.REF.)** when you enter in weighing mode is necessary to proceed in this way:

- Load the weight on the scale;
- Swipe the badge or approaching the card at least 5 cm at the RFID for the automatic selection of the vehicle;
- Once you have selected the vehicle, the indicator makes automatically the input weighing and prints;
- Remove the weight from the scale and pass by zero (the vehicle is deselected automatically);
- Load again the weight on the scale;
- Swipe again the badge or approaching again the card for the automatic selection of the vehicle;
- The indicator makes automatically the output weighing and prints

SIMPLE PRINTOUT

If the automatic input/output step is SIMPLE PRINTOUT **F.ModE >> totAL >> A.inout (TECH.MAN.REF.)** when you enter in weighing mode is necessary to proceed in this way:

- Load the weight on the scale;
- Swipe the badge or approaching the card at least 5 cm at the RFID for the automatic selection of the vehicle;
- The indicator makes automatically the simple printout.

14.3 SELF SERVICE SYSTEM WITH COIN

To use the COIN you have to set the parameters in the step **F.ModE >> totAL >> SELF.C (TECH.MAN.REF.)** and when you enter in weighing mode is necessary to proceed in this way:

- Load the weight on the scale;
- Insert the amount indicated. (money or coin);
- The indicator makes automatically the simple printout.

15. PRINTOUTS

The instrument is fitted with 12 different print functions, which may be used while weighing, and of 30 print formats, in other words, 30 different memory storages, each of which contain a programmable printout.

The printouts executed by 12 of these functions depends on the print format linked to it; see the following section for the linkages.

The format linking function allows executing various printouts, by changing the linked format each time.

The available functions are:

SIMPLE PRINTOUT

- Programmable printout -

Through the **F5** key one prints the linked format, **without executing the input/output weigh or single weigh**.

With the APPROVED instrument:

- The printing works if there is a NET WEIGHT of at least 20 divisions.
- The printout is reenabled depending on how the **F.ModE >> rEACt** parameter has been programmed in the TECHNICAL SET-UP (**TECH.MAN.REF.**).
- The simple print function excludes the totalisation and vice versa.

With the NON APPROVED instrument:

- The printing works if there is a NET WEIGHT greater than zero.
- The simple printout does not exclude the totalisation and is always active (the programming of the F.ModE >> rEACt parameter of the TECHNICAL SET-UP TECH.MAN.REF. is not taken into consideration).

INPUT WEIGH

- Programmable printout -

With the **F6** key one prints the data relative to the INPUT WEIGH (format linked to the **S.F.06** function), or to the SINGLE WEIGH (format linked to the **S.F.05** function) in case the known tare has been entered.

For the totalisation conditions, see section 13.4.

OUTPUT WEIGH

- Programmable printout -

With the **F7** key one prints the data relative to the OUTPUT WEIGH (format linked to the **S.F.07** function) or to the SINGLE WEIGH (format linked to the **S.F.05** function) in the case that the known tare has been entered.

For the totalisation conditions, see section 13.4.

CUSTOMER TOTAL

- Programmable printout -

By pressing the **2nd F** key followed by **F1**, the CUSTOMER TOTAL is printed and then cleared as well as the printing of the format linked to the **S.F.08** function. Please find below the default printout:

DESCRIPTION1

DESCRIPTION2

DESCRIPTION3

TOTAL INPUT WEIGHT = net weight of the quantity which has entered in the factory (in other words the sum of the net weights greater than zero [so with the input weight greater than the output weight], **of all the pairs and of the single weighs carried out**).

TOTAL OUTPUT WEIGHT = net weight of the quantity which has left the factory (in other words the sum of the net weights less than zero [so with the input weight less than the output weight], **of all the pairs and of the single weighs carried out**).

NET TOTAL = the net of all transactions (TOTAL OUTPUT WEIGHT minus the TOTAL INPUT WEIGHT).

WEIGHS TOTAL = number of weigh pairs (input weigh with relative output weigh) and of all the single weighs carried out.

MATERIAL TOTAL

- Programmable printout -

By pressing the **2nd F** key followed by **F2**, the MATERIAL TOTAL is printed and then cleared as well as the printing of the format linked to the **S.F.09** function. Please find below the default printout:

DESCRIPTION1

DESCRIPTION2

TOTAL INPUT WEIGHT = net weight of the quantity which has entered in the factory (in other words the sum of the net weights greater than zero [so with the input weight greater than the output weight], **of all the pairs and of the single weighs carried out**).

TOTAL OUTPUT WEIGHT = net weight of the quantity which has left the factory (in other words the sum of the net weights less than zero [so with the input weight less than the output weight], **of all the pairs and of the single weighs carried out**).

NET TOTAL = the net of all transactions (TOTAL OUTPUT WEIGHT minus the TOTAL INPUT WEIGHT).

WEIGHS TOTAL = number of weigh pairs (input weigh with relative output weigh) and of all the single weighs carried out.

VEHICLE TOTAL

- Programmable printout -

By pressing the **2nd F** key followed by **F3**, the VEHICLE TOTAL is printed and cleared as well as the printing of the format linked to the **S.F.10** function. Please find below the default printout:

DESCRIPTION

PLATE

TARE

TOTAL INPUT WEIGHT = net weight of the quantity which has entered in the factory (in other words the sum of the net weights greater than zero [so with the input weight greater than the output weight], **of all the pairs and of the single weighs carried out**).

TOTAL OUTPUT WEIGHT = net weight of the quantity which has left the factory (in other words the sum of the net weights less than zero [so with the input weight less than the output weight], **of all the pairs and of the single weighs carried out**).

NET TOTAL = the net of all transactions (TOTAL OUTPUT WEIGHT minus the TOTAL INPUT WEIGHT).

WEIGHS TOTAL = number of weigh pairs (input weigh with relative output weigh) and of all the single weighs carried out.

PARTIAL TOTAL

- Programmable printout -

By pressing the **F8** key the PARTIAL TOTAL is printed and then cleared as well as the printing of the format linked to the **S.F.02** function.

GENERAL TOTAL

- Programmable printout -

By pressing the **F9** key the GENERAL TOTAL is printed and then cleared as well as the printing of the format linked to the **S.F.03** function.

GRAND TOTAL

- Programmable printout -

By pressing the **F10** key the GRAND TOTAL is printed and then cleared as well as the printing of the format linked to the **S.F.04** function.

START-UP PRINTOUT

- Programmable printout -

When turning on the indicator, the printout of the format linked to the **S.F.11** function is made; this function can be used, for example, to unlock the pincers of the TM295 printer (when this last is turned on the pincers are always locked).

CALCULATOR RESULT

- Programmable printout -

Once terminated the operation with the "CALCULATOR" function, the format linked to the **S.F.12** function is printed. See section 18.1.

15.1 LINKING OF THE FORMATS TO THE PRINT FUNCTIONS

Through function **200**, combinable with the desired key (<< **F.KEYS** >> step, **TECH.MAN.REF.**), one accesses the linking of the print formats (configurable in the **SETuP >> SEriAL >> Prn.FMt** step **TECH.MAN.REF.**) to the 12 programmable print functions:

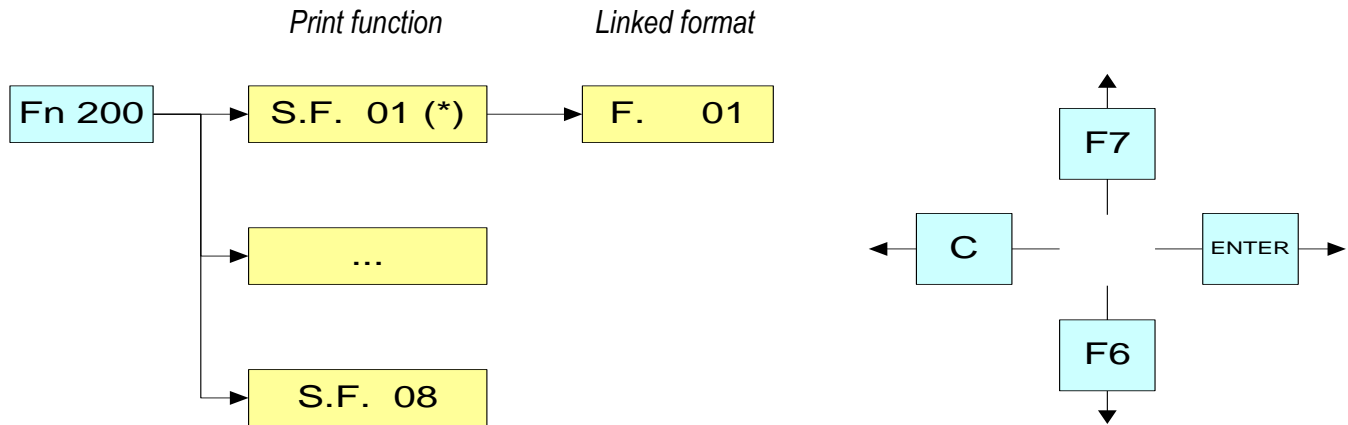

Print Functions	Key	Linked step
PRINT KEY	F5	S.F. 01
PARTIAL TOTAL	F8	S.F. 02
GENERAL TOTAL	F9	S.F. 03
GRAND TOTAL	F10	S.F. 04
SINGLE WEIGH	F6 or F7	S.F. 05
INPUT WEIGH	F6	S.F. 06
OUTPUT WEIGH	F7	S.F. 07
CUSTOMER TOTAL	2nd F followed by F1	S.F. 08
MATERIAL TOTAL	2nd F followed by F2	S.F. 09
VEHICLE TOTAL	2nd F followed by F3	S.F. 10
START-UP PRINTOUT	Automatic entry	S.F. 11
RESULT OF THE CALCULATOR	Automatic entry	S.F. 12

TO LINK THE FORMAT:

- Recall function **200**, combinable with the desired key (<< **F.KEYS** >> step, **TECH.MAN.REF.**).

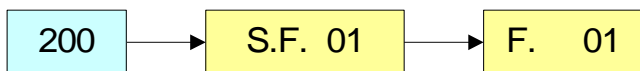

- The LCD display shows:

S.F. XX in which:
XX indicates the number of the function (from 01 onwards) to which the print format is linked.

- Select the print function (for example S.F. 01) through the arrow keys ▲ ▼ and press the **ENTER** key.
- Once entered, the display shows:

XX in which:
XX indicates the number of the format to be linked.

- Type the format number and press **ENTER**.

NOTE: In order to no link any format to a vector one should enter the number 00.

15.1.1 QUICK LINKING OF THE FORMATS

By linking the number of a specific print function to the function **200** (preamble function in the << **F.KEYS** >> step, **TECH.MAN.REF.**), it is possible to access directly to the modification of it with a direct key, for example F1 key to quickly link the S.F. 1, and F2 key to quickly link the S.F. 2.

Furthermore for some print functions the desired formats can be quickly linked by setting directly the corresponding code(function) to the desired key (<< **F.KEYS** >> step, **TECH.MAN.REF.**) without having to program the preamble:

CODE	QUICK LINKING FUNCTION	PRINT FUNCTION
200	Format linking to the Simple Printout (Prn.Fmt)	S.F. 01
201	Format Linking to the Partial Total Printout (SND.FMT)	S.F. 02
310	Format Linking to the Input Weigh Printout (FM.IN)	S.F. 06
311	Format Linking to the Output Weigh Printout (FM.OUT)	S.F. 07
312	Format Linking to the Single Weigh Printout (FM.SING)	S.F. 05

TO QUICK LINK THE FORMAT:

- Recall the desired format, by pressing the linked key (<< **F.KEYS** >> step, **TECH.MAN.REF.**).
- The LCD display shows:
XX in which:
XX indicates the number of the format to be linked.
- Type the format number and press **ENTER**.

NOTE: In order to no link any format to a print function one should enter the number 00.

15.2 NUMBER OF TICKET COPIES

Through function **400**, combinable with the desired key (<< **F.KEYS** >> step, **TECH.MAN.REF.**), any printout will be made various times depending on the number set in this step (from 1 to 5).

15.3 REPETITION OF THE LAST EXECUTED PRINTOUT

By pressing in sequence the **2nd F** and **F5** keys the last executed printout is repeated; however, it's not possible to reprint any selected databases, and the date/time will be of the copy just reprinted.

NOTE: If one wants to execute more than one printout, it's advisable to recall function **400** (see section 14.2).

15.4 STANDARD PRINTING FORMATS

The **SEtuP >> SEriAL >> dEF.Prn** parameter of the set-up environment (**TECH.MAN.REF.**) allows to enable the default printouts for the TPR printer.

NOTE: By enabling these printouts all the formatted print formats will be CANCELLED and will be SUBSTITUTED by the standard formats, which automatically will be linked to the 12 print functions.

16. OTHER FUNCTIONS

16.1 CALCULATOR

Through function **114** combinable with the desired key (<< **F.KEYS** >> step, **TECH.MAN.REF.**), one enables the calculator function.

- **ADDITION**
- **MULTIPLICATION**
- **SUBTRACTION**

Procedure:

- Enter the first value using the numerical keyboard.
- Press **F1** to add, **F2** to multiply, **F3** to subtract the value.

Terminate the operation:

- **TYPE** the second value and **PRESS ENTER**: the result will be shown for a few seconds on the display.
- **TYPE** the second value and **PRESS TARE**: the result will be shown for a few seconds on the display and will be added (if an addition and multiplication) or subtracted (if subtraction) to the current tare value.
- **PRESS 2nd F**: the NET weight on the scale will be used as a second value and the result will be shown for a few seconds on the display.

In the end the printing of the "CALCULATOR" will be executed anyway (See section 14 **PRINTOUTS**).

To disable the calculator function, press the C key.

HELP FUNCTION

By pressing at length the **/HELP** key it is possible to see the list of the keys used in the calculator function.

If one wants to scroll the list of the keys in manual mode, it is possible to use the arrow keys (F6 ▼ and F7 ▲).

16.2 DISPLAY OF NET WEIGHT WITH SENSITIVITY X 10 (for testing use during calibration)

By pressing at length the **F2** key one will view the net weight with sensitivity times 10 (press again at length the **F2** key to return to the normal visualisation).

NOTES:

- **With approved indicator, the visualisation lasts about 5 seconds, after which it's disabled.**
- **The printout can only be done when the indicator has the standard sensitivity.**

16.3 SETTING DATE / TIME

By pressing at length the **F3** key 'it's possible to quickly access the setting from the date / time of the instrument:

DAY ⇒ **ENTER** ⇒ MONTH ⇒ **ENTER** ⇒ YEAR ⇒ **ENTER** ⇒ HOUR ⇒ **ENTER** ⇒ MINUTES ⇒ **ENTER**.

16.4 SET-POINT FUNCTION

The indicator is supplied with 4 outputs (optional) that can be used for different functions, besides, through the I/O expansion board (in the IO version) it is possible to use another 12.

In the **SEtuP >>outPut >> r.ConF** menu (**TECH.MAN.REF**) it is possible to set the characteristics of each output which will be used: normally open or normally closed; upon direct control or weight stability, with hysteresis or without, the functioning mode.

It is also possible to set whether the enabling of the output excludes the check on the previous outputs (see the **SEtuP >>outPut >> r.ModE** parameter).

16.4.1 NORMAL FUNCTIONING MODE

By setting the **SEtuP >> outPut >> r.ModE** parameter on "norMAL", one configures the independent use of the outputs:

- the check is always made on all the set outputs
- the enabling of one of these does not provoke the disabling of the others.

16.4.1.1 SETPOINT ON THE GROSS WEIGHT

Functioning with hysteresis (rLiSt "HYSTERESIS" parameter set as **iSt.on**)

By selecting this functioning mode the output function on the GROSS weight is activated; one enters two SET POINTS for each output: a DISABLING one, which, when the gross weight is lower than it, disables the appropriate output; an ENABLING one, which, when the gross weight is greater or equal than it, it enables the appropriate output. Through function **202**, combinable with the desired key (<< **F.KEYS** >> step, **TECH.MAN.REF.**), the SET POINT values are entered (DISABLING and ENABLING) for each configured output:

- The display shows " S.1 on " (relay 1 ENABLING SETPOINT): press **ENTER**, enter the weight value with the keyboard and confirm with **ENTER** (use the **C** key to quickly zero the current value).
- The display shows " S.1 oFF" (relay 1 DISABLING SETPOINT): press **ENTER**, enter the weight value with the keyboard and confirm with **ENTER** (use the **C** key to quickly zero the current value).
- Proceed in the same way for the following outputs (if present).
- When finished programming the set points, exit with the **C** key.

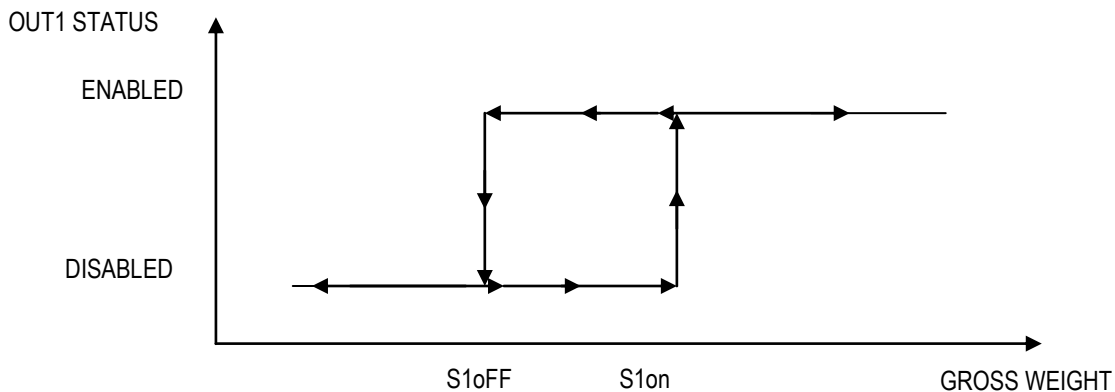

Functioning without hysteresis (rLiSt "HYSTERESIS" parameter set as **iSt.oFF**)

The operating mode is the same as the previous one, except that just one SETPOINT is entered for each output ("S.1 on"); for this purpose **the access to the " S.1 oFF " parameter is inhibited.**

NOTES

- If all the outputs have the "NONE" (none) functioning mode, the enabling of the 202 function has no effect.
- The DISABLING SETPOINT must be less or equal to the ENABLING ones; if a value greater than the ENABLING one is entered and confirmed in the DISABLING SETPOINT, the indicator will set at 0 the set point, until a correct value is entered.
- If a value lower than the DISABLING one is entered and confirmed in the ENABLING SETPOINT, that value is accepted, but the DISABLING SETPOINT is put at 0.
- The 0 value is valid on both the set point values.
- The SETPOINT check of the weight remains active on the present value even during the modification of the SET POINT, until the new value is confirmed.
- At start-up, the relays are managed from when the weight is displayed and these take on the configuration set in the set-up environment. These are not managed inside the technical set-up.
- In case of weight not valid (local or from remote scale) all the outputs will be disabled.

16.4.1.2 SETPOINT ON THE NET WEIGHT

By selecting this functioning mode, the output function on the NET weight is enabled; the entry of the SET POINTS and the specifications are the same as the functioning mode on the gross weight.

16.4.1.3 GROSS WEIGHT AT ZERO

By selecting this functioning mode, the output function on the GROSS weight at 0 is enabled.

16.4.1.4 NET WEIGHT AT ZERO

By selecting this functioning mode, the output function on the NET weight at 0 is enabled.

16.4.1.5 INSTABILITY

By selecting this functioning mode, the output function on the unstable weight is enabled.

16.4.1.6 TOTALISATION

By selecting this functioning mode, the output function is enabled after executing a single weigh or after an output weight (at the end of an input/output cycle); the output remains enabled until the weigh is restored; in other words, by the passing by zero of the net weight or by weight instability (see **F.ModE** >> **rEAct** "REACTIVATIONS" parameter of the TECHNICAL SET-UP, **TECH.MAN.REF.**).

16.4.1.7 SETPOINT ON THE PARTIAL TOTAL

By selecting this functioning mode, the output function is enabled on the sum between the NET weight on the scale and the accumulated net partial total; the entry of the SET POINTS and the specifications are the same as the functioning mode on the gross weight.

16.4.1.8 SETPOINT ON THE GENERAL TOTAL

By selecting this functioning mode, the output function is enabled on the sum between the NET weight on the scale and the accumulated net general total; the entry of the SET POINTS and the specifications are the same as the functioning mode on the gross weight.

16.4.1.9 SETPOINT ON THE GRAND TOTAL

By selecting this functioning mode, the output function is enabled on the sum between the NET weight on the scale and the accumulated net grand total; the entry of the SET POINTS and the specifications are the same as the functioning mode on the gross weight.

16.4.1.10 SETPOINT ON THE NEGATIVE NET WEIGHT

Functioning with hysteresis (rL.iSt "HYSTERESIS" parameter set as iSt.on)

By selecting this functioning mode the outputs function on the NEGATIVE NET weight is activated; one enters two NEGATIVE SET POINTS for each output: a DISABLING one, which, when the NET weight is greater than it, disables the appropriate output; an ENABLING one, which, when the NET weight is lower or equal than it, it enables the appropriate output.

The entry and specifications are the same for the functioning mode on the gross weight.

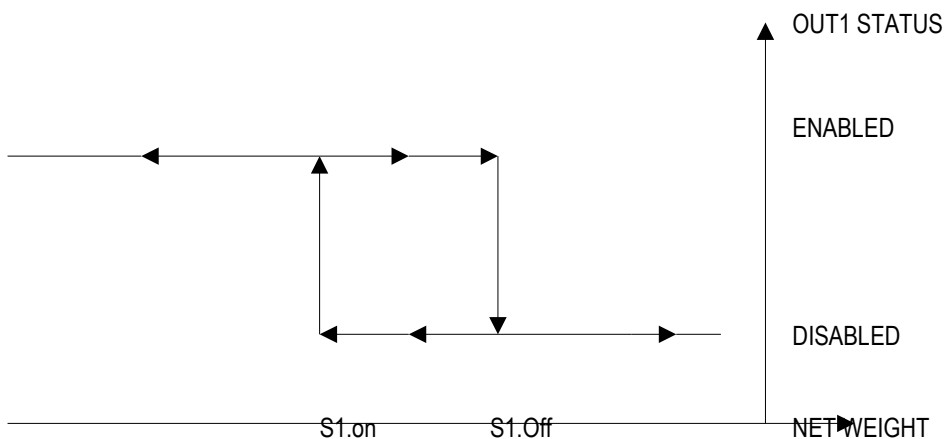

Functioning without hysteresis (rL.iSt "HYSTERESIS" parameter set as iSt.oFF)

The operating mode is the same as the previous one, except that just one SETPOINT is entered for each output (" S.1 on "); for this purpose **the access to the " S.1 OFF " parameter is inhibited.**

The entry and specifications are the same for the functioning mode on the gross weight.

16.4.1.11 OPERATION MADE

By selecting this functioning mode, the output function is enabled after the execution of an input or output weigh; the relay remains enabled until the weigh is restored; in other words, by the passing by zero of the net weight or by weight instability (see **F.ModE** >> **rEAct** "REACTIVATIONS" parameter of the TECHNICAL SET-UP, **TECH.MAN.REF.**).

16.4.1.12 WEIGHT ACQUISITION

By selecting this functioning mode, the output function is enabled after the weight acquisition; the relay remains enabled until the weigh is restored; in other words, by the passing by zero of the net weight or by weight instability (see **F.ModE** >> **rEAct** "REACTIVATIONS" parameter of the TECHNICAL SET-UP, **TECH.MAN.REF.**).

16.4.1.13 CONTROL LIGHT

By selecting this functioning mode the output function on the NET weight is enabled: when the net weight is equal or greater than the ENABLING SET POINT, the relay is disabled.

The relay is disabled until the execution of an input or output weight; after this, the relay is activated and remains activated until the weight is lower than the ENABLING SET POINT, and the weight doesn't surpass it once again.

If the relay is disabled and no input or output weight is made, the functioning is the same as that of the set point on the net weight.

FUNCTIONING WITH 1 CONTROL LIGHT:

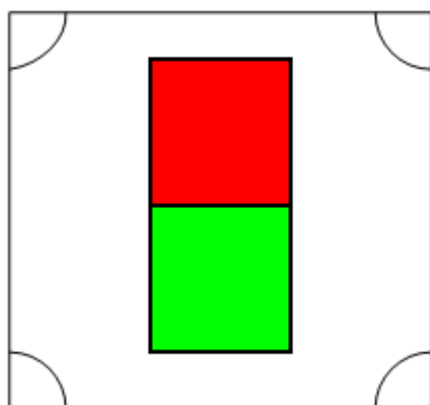

RED → R1, functioning with control light, normally CLOSED, ENABLING SET POINT 10kg.

GREEN → R2, functioning with control light, normally OPEN, ENABLING SET POINT 10kg.

- The scale is unloaded and the vehicle is not yet positioned on the scale: the GREEN light turns on.
- The vehicle is now positioned on the scale. When the ENABLING SET POINT is reached, the GREEN light turns off and the RED light turns on.
- After the execution of the input or output weight, the RED light turns off and the GREEN light turns back on.
- The vehicle descends from the scale and the GREEN light continues to stay on.
- It is possible to execute another input/output weigh with the same procedure.

FUNCTIONING WITH 2 CONTROLS LIGHT:

The functioning mode with 2 independents controls light is equal to the functioning previously decribed, with the difference that it's possible to manage 2 independents scales, each with one different control light.

SCALE 1

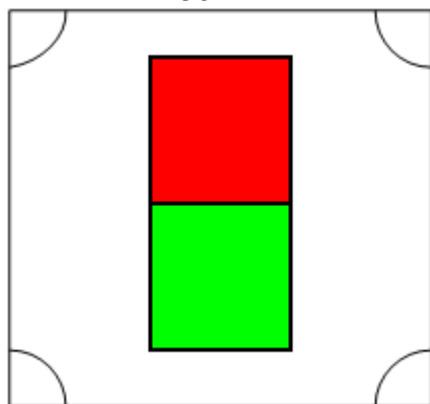

RED → **R1**, functioning with **control light**, normally CLOSED, ENABLING SET POINT 10kg.

GREEN → **R2**, functioning with **control light**, normally OPEN, ENABLING SET POINT 10kg.

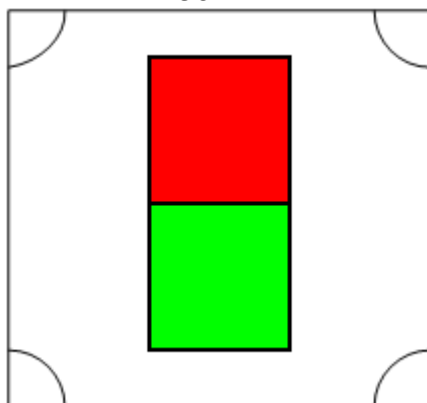
SCALE 2

RED → **R3**, functioning with **control light for the second scale**, normally CLOSED, ENABLING SET POINT 10kg.

GREEN → **R4**, functioning with **control light for second scale**, normally OPEN, ENABLING SET POINT 10kg.

16.4.2 EXCLUSIVE FUNCTIONING MODE

By setting the **SEtUP >> outPut >> r.ModE** parameter on “EXCLuS”, one configures the exclusive use of the outputs:

- The check is made on all the set outputs starting from the last one (OUT16) to the first one (OUT1).
- When one of these is enabled the check on the previous ones is excluded.

By selecting this functioning mode and setting the set points in increasing order, one can create outputs activation ranges.

Example:

RELAY	SETPOINT	ACTIVATION RANGE
rL. 1	1.000 kg	From 1.000 to 1.999
rL. 2	2.000 kg	From 2.000 to 2.999
rL. 3	3.000 kg	From 3.000 to 3.999
rL. 4	4.000 kg	From 4.000 onwards.

In this case, if the weight reaches 2.500 kg, ONLY THE “rL. 2” OUTPUT IS ENABLED; if the weight reaches 4.500 kg, ONLY THE “rL. 4” OUTPUT IS ENABLED.

16.4.3 QUICK MODIFICATION OF THE SETPOINTS

By linking the number of a specific setpoint to the function **202** (preamble function in the << **F.KEYS** >> step, **TECH.MAN.REF.**), it is possible to access directly to the modification of it with a direct key, for example F1 key to quickly modify the SETPOINT 1, and F2 key to quickly modify the SETPOINT 2.

16.5 DIAGNOSTIC PERIPHERALS

Through function **118** combinable with the desired key (<< **F.KEYS** >> step, **TECH.MAN.REF.**), one enables the diagnostic peripherals function.

The display shows:

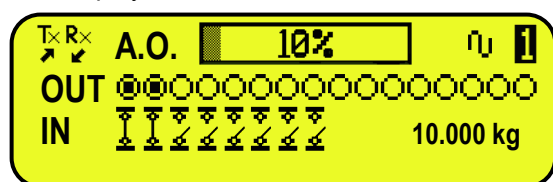

STATUS	DESCRIPTION
ANALOGIC OUTPUT(A.O)	Analogue output value express as a percentage.
OUTPUTS (OUT)	Status output, non active (○) or active (●).
INPUTS (IN)	Status input, non active (⚡) or active (⚡).
SERIAL COMUNICATIOS (Tx RX)	The serial communication is active with external device.
WEIGHT	Status of the weight: - unloaded scale; - unstable weight;
SCALE	Number of the active scale (example , see section 5 SCALE SELECTION) and the relative weight loaded.

16.6 COM DATA DIAGNOSTIC

Through function **119** combinable with the desired key (<< **F.KEYS** >> step, **TECH.MAN.REF.**), one enables the Com data diagnostic function. The display shows:

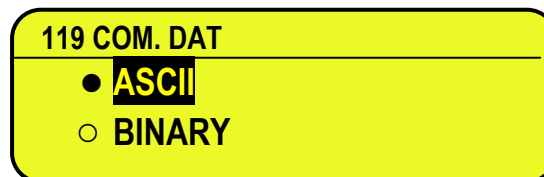
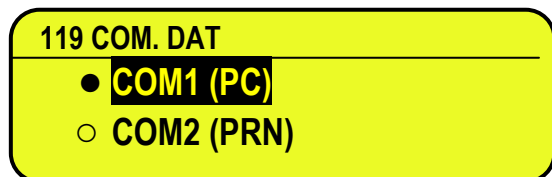

In the first screen one selects the port on which the diagnostic control should be executed. While in the second screen, one selects the code that one wants to use for viewing the data in transit.

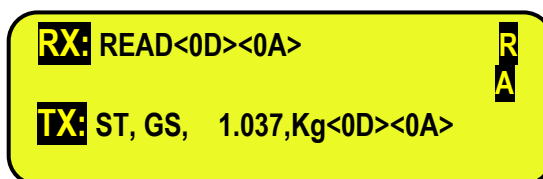

When the data on the RX and TX reception and transmission lines are correctly displayed, then the functioning of the relative serial line is considered to be correct.

NOTE: By pressing the **.HELP** key, it's possible to see the keys list used in the menu.

17. ALIBI MEMORY

The alibi memory allows storing the executed weighs or the weights transmitted to the PC.

The stored values can then be recalled by the PC serial line or directly on the indicator's LED display for a following check.

The data filed with each weigh or upon each weight transmission is:

- Gross weight
- Tare
- Unit of measure
- Number of selected scale

The memorisation of a weigh takes place:

- Following the reception of a command through the serial line. (**TECH.MAN.REF.**)
- Upon the printing made with the F5 key or upon totalisation

17.1 READING OF THE WEIGHS CARRIED OUT

Through function **427**, combinable with the desired key (<< **F.KEYS** >> step, **TECH.MAN.REF.**) it's possible to read a carried out weigh:

first enter the rewriting number of the Alibi memory (rEW.id), confirm with **ENTER**, and then enter the weigh number (id) and press **ENTER**. The ID is accepted only if valid.

If the alibi memory is empty the message "EMPTY" appears on the LCD display for a few instants; if the ID code entered is not valid, the "no id" message appears for a few instants, and then one exits the step.

By entering a valid ID code, the LCD display shows the following data, selectable through the arrow keys ▲ ▼ :

Ch.X in which X is the selected channel number (from 0 to 4)

Gross weight value with unit of measure;

Tare weight value with unit of measure;

Press **C** to exit the reading state of the weighs.

NOTE: It is possible to read the weigh carried out also through the PC serial line (see the “WEIGH READING” serial command in the following section).

17.2 ALIBI MEMORY CANCELLATION (only with non approved instrument)

It is possible to cancel all the weighs, with the alibi memory initialization, this operation is possible only in SETUP environment or with a serial command (**TECH.MAN.REF**)

18. MESSAGES

While using the indicator, it is possible to incur into the following errors:

18.1 INSIDE THE SET-UP OR MENU OR AT START-UP

VISUALIZATION		DESCRIPTION
Err. – 36	CALIBRATION ERROR	During the calibration some internal negative points have been calculated: <ul style="list-style-type: none"> - the calibration point is less than the zero point. - the signal is negative (check the connections)
Err. – 37	CALIBRATION ERROR	During the calibration some internal points less than the minimum value have been calculated: <ul style="list-style-type: none"> - the calibration point is equal to the zero point. - A capacity too high in relation to the division has been set.
Err. – 38	CALIBRATION ERROR	Range not valid: please check that RANGE 1 < RANGE 2 < RANGE 3.
	Err. – 39	Range not valid: please check that RANGE 1 < RANGE 2 < RANGE 3.
	Err. – 39 NO CALIBRATION	Invalid calibration range number (there is the value 0 or values greater than 3); one must execute a TECHNICAL DEFAULT (dFLt.t parameter of the SET-UP environment), if not already executed previously, and carefully carry out the calibration.
	Err. – 72	Equalization coefficient adjustment not allowed because a too low sample weight has been used.
	Err. – 85	Equalization coefficient adjustment not allowed because the instrument has not been calibrated.
Err. – 98	TIMEOUT CONVERTER ERROR	This error is visible only in the indicator startup, if the instrument has not a correct communication with the weight converter
Err.Mot	ERROR: UNSTABLE WEIGHT	It is shown when, during the sampling phase, the weight results to be unstable and therefore can not be acquired. By pressing a key it is required to press ENTER to retry, C to exit or 1 to accept the unstable value detected.
	ErPnt	During the acquisition of a calibration point, a null value from the converter has been read.
SAVE ?	EXITING SETUP: SAVE ?	The instrument requests the saving when exiting the set-up; press ENTER to confirm or C to not continue.
	SURE?	The instrument requests a confirmation before proceeding: press ENTER to confirm or C to not continue.
	Error	Generic error. Possible motives can be: <ul style="list-style-type: none"> - Division not valid: please check that DIVISION 1 < DIVISION 2 < DIVISION 3; - An error has taken place in the connection, configuration, equalisation, calibration of the cells, etc.
	ERROR SX CELL Y	It is shown when there is an error in the communication with the X scale – Y cell : check the connections and communication parameters (TECH.MAN.REF.).

NET.ERR.	NETWORK ERROR: NO SETH	It is shown when the SETH device is not recognized.
NET.ERR.	NETWORK ERROR: NO CONNECTION	It is shown when there are some problems of connection.
NET.ERR.	NETWORK ERROR: INCOHERENT DB PRESS ENTER TO ALIGN	It is shown when the automatic alignment of databases is disabled and weigh list date and time don't match or other archives date and time don't match. By pressing enter the alignment procedure is executed, by pressing another key the instrument stays on-line but cannot work until the archives are aligned.
NET.ERR.	NETWORK ERROR NET FW ERROR PRESS A KEY	It is shown when the firmwares of the instruments connected together are different.
ERR CELL	ERROR CELL IN THE STEP "MILLIVOLT" IN DIAG	Shortcircuit EXC+ with SEN+, EXC- with SEN- (because they are not shortcircuit from default) and SIG+ with SIG-, so it is possible to enter in the step millivolt of the diagnostic and the indicator show 0 more or less. So check the connections of the load cell.

NOTE: if the Er – XX error appears after the indicator start-up; press the TARE key to enter in the SET-UP environment.

18.2 IN WEIGHING

MESSAGE	DESCRIPTION
WEIGHT UNDER 20 DIVISIONS	It is shown in the LCD display when one tries to print or totalise with the 0 or negative weight.
NO ZERO CROSS OR INSTABILITY	Printing or totalisation not possible without having the weight pass by the net zero or by instability.
*** POWER OFF ***	Turning off of the instrument through the key (see section 3.2).
“- OUT CAPACITY ! –“	OVERLOAD The weight is 9 divisions above the Maximum Capacity . OR UNDERLOAD - Approved instrument: The weight is under the gross zero (-100 divisions). - Non approved instrument: The weight is under the gross zero (- capacity – 9 divisions).
ZERO	Execution of scale zero (see section 6).
TARE	Tare execution (see section 7).
CLEAR	Tare cancellation (see section 7.4)
prn-on	Turning on printer for maintenance (see section 3.3).
GROSS	Visualisation of the gross weight.
NET	Visualisation of the net weight.
LOCK	Tare lock or enabled keyboard function.
UNLOCK	Tare lock or disabled keyboard function.
Low.Batt	Indicates that the battery is discharged (voltage at minimum level).
PRINTER ERROR: CHECK THE CTS!	Error during the printing: totalisation not possible or printing not executed / finished.

USER - PRESS KEY	See section 12.
ERROR SX CELL Y	It is shown when there is an error in the communication with the X scale – Y cell : check the connections and communication parameters (TECH.MAN.REF.).

DECLARATION OF CONFORMITY

This device conforms to the essential standards and norms relative to the applicable European regulations. The Declaration of conformity is available in the web site www.diniargeo.com

WARRANTY

The TWO-YEAR warranty period begins on the day the instrument is delivered. It includes spare parts and labour for repairs at no charge if the INSTRUMENTS ARE RETURNED prepaid to the DEALER'S PLACE OF BUSINESS. Warranty covers all defects NOT attributable to the Customer (so are not included in the warranty, failures resulting from improper use) and NOT caused during transport.

If on site service is requested (or necessary), for any reason, where the instrument is used, the Customer will pay for all of the service technician's costs: travel time and expenses plus room and board (if any).

The customer pays for shipping costs (both ways), if the instrument is shipped to the DEALER or manufacturer for repair.

The WARRANTY is VOIDED if faults occur due to work done by unauthorised personnel or due to connections to equipment installed by others or incorrect connection to the power supply.

This warranty DOES NOT provide for any compensation for losses or damages, direct or indirect, incurred by the Customer due to complete or partial failure of instruments or systems sold, even during the warranty period.

AUTHORISED SERVICE CENTRE STAMP

