



DEFENDER™3000

Washdown Bench Scales



Stainless Steel Bench Scales for Basic Industrial Washdown Applications

The Defender 3000 Washdown Bench Scales are ideal for general weighing, simple counting and checkweighing applications in damp environments, or when washdown cleaning is required. The Defender 3000 Series features a simple, yet rugged, stainless steel design and IP66 stainless steel indicator with tactile keys, multicolor backlit LCD display, AC or standard rechargeable battery operation and flexible mounting capabilities.

Unique Features:

- Results are clearly shown using the large, bright backlit LCD display. In Checkweighing mode display changes color (yellow/green/red) to alert when within the target weight range.
- This tough industrial scale features a 304-stainless steel platform and frame, column and IP67 load cell. Indicator features a protected 304-stainless steel housing and mounting bracket with IP66 protection rate.
- Features software for Parts Counting, Checkweighing and Totalization. Includes RS232 with optional USB Device or Ethernet for printing or data connectivity. Approved models are equipped with EasyConnect™ solution.

DEFENDER™3000 Washdown Bench Scales

Specifications

Column Mount Bench Scale

Model	i-D33XW15C1R6-EU	i-D33XW30C1R6-EU	i-D33XW60C1R6-EU	i-D33XW60C1L7-EU
	i-D33XW15C1R6-GB	i-D33XW30C1R6-GB	i-D33XW60C1R6-GB	i-D33XW60C1L7-GB
Capacity x Default Readability	15 kg x 2 g	30 kg x 5 g	60 kg x 10 g	
Maximum Displayed Resolution	1:7,500	1:6,000		
Linearity/Repeatability	±1d			
Certified Model	i-D33XW15C1R6EU-M	i-D33XW30C1R6EU-M	i-D33XW60C1R6EU-M	i-D33XW60C1L7EU-M
	i-D33XW15C1R6GB-M	i-D33XW30C1R6GB-M	i-D33XW60C1R6GB-M	i-D33XW60C1L7GB-M
Capacity x Certified/Approved Readability	15 kg x 5 g	30 kg x 10 g	60 kg x 20 g	
Maximum Certified Resolution	1:3,000			
Indicator	304 stainless steel indicator			
Column	330 mm stainless steel			680 mm stainless steel
Base Construction	Stainless steel removable weighing platform with stainless steel frame, silicon sealed IP67 stainless steel loadcell			
Safe Overload Capacity	150% of maximum capacity			
Stabilization Time	Within 1 second			
Operating Temperature Range	-10°C to 40°C			
Scale Dimensions (A x B x C x D x E x F)	355 x 305 x 121.8 x 75 x 541.6 x 481.9 mm			550 x 420 x 134 x 80 x 896.1 x 685.6 mm
Shipping Dimensions (L x W x H)	642 x 497 x 212 mm M models: 495 x 455 x 373 mm			857 x 564 x 225 mm M models: 1022 x 687 x 247 mm
Approx. Net Weight	12.3 kg			19.2 kg
Approx. Shipping Weight	15.3 kg			23.3 kg

Model	i-D33XW150C1L7-EU	i-D33XW150C1X7-EU	i-D33XW300C1X7-EU
	i-D33XW150C1L7-GB	i-D33XW150C1X7-GB	i-D33XW300C1X7-GB
Capacity x Default Readability	150 kg x 20 g		300 kg x 50 g
Maximum Displayed Resolution	1:7,500		1:6,000
Linearity/Repeatability	±1d		
Certified Model	i-D33XW150C1L7EU-M	i-D33XW150C1X7EU-M	i-D33XW300C1X7EU-M
	i-D33XW150C1L7GB-M	i-D33XW150C1X7GB-M	i-D33XW300C1X7GB-M
Capacity x Certified/Approved Readability	150 kg x 50 g		300 kg x 100 g
Maximum Certified Resolution	1:3,000		
Indicator	304 stainless steel indicator		
Column	680 mm stainless steel		
Base Construction	Stainless steel removable weighing platform with stainless steel frame, silicon sealed IP67 stainless steel loadcell		
Safe Overload Capacity	150% of maximum capacity		
Stabilization Time	Within 1 second		
Operating Temperature Range	-10°C to 40°C		
Scale Dimensions (A x B x C x D x E x F)	550 x 420 x 134 x 80 x 896.1 x 685.6 mm	650 x 500 x 150 x 90 x 894.6 x 784.6 mm	
Shipping Dimensions (L x W x H)	857 x 564 x 225 mm M models: 1022 x 687 x 247 mm	1022 x 687 x 247 mm M models: 1022 x 687 x 247 mm	
Approx. Net Weight	19.2 kg	31.8 kg	
Approx. Shipping Weight	23.3 kg	35.3 kg	

DEFENDER™3000 Washdown Bench Scales

Specifications

Front Mount Bench Scale

Model	i-D33XW15C1R5-EU	i-D33XW30C1R5-EU	i-D33XW60C1R5-EU	i-D33XW60C1L5-EU
	i-D33XW15C1R5-GB	i-D33XW30C1R5-GB	i-D33XW60C1R5-GB	i-D33XW60C1L5-GB
Capacity x Default Readability	15 kg x 2 g	30 kg x 5 g	60 kg x 10 g	60 kg x 10 g
Maximum Displayed Resolution	1:7,500	1:6,000		
Linearity/Repeatability	±1d			
Certified Model	i-D33XW15C1R5EU-M	i-D33XW30C1R5EU-M	i-D33XW60C1R5EU-M	i-D33XW60C1L5EU-M
	i-D33XW15C1R5GB-M	i-D33XW30C1R5GB-M	i-D33XW60C1R5GB-M	i-D33XW60C1L5GB-M
Capacity x Certified/Approved Readability	15 kg x 5 g	30 kg x 10 g	60 kg x 20 g	
Maximum Certified Resolution	1:3,000			
Indicator	304 stainless steel indicator			
Column	304 stainless steel front-mount bracket with handle			
Base Construction	Stainless steel removable weighing platform with stainless steel frame, silicon sealed IP67 stainless steel loadcell			
Safe Overload Capacity	150% of maximum capacity			
Stabilization Time	Within 1 second			
Operating Temperature Range	-10°C to 40°C			
Scale Dimensions (A x B x C x D x E x F)	355 x 305 x 121.8 x 75 x 130 x 645.5 mm			550 x 420 x 134 x 80 x 132.9 x 842 mm
Shipping Dimensions (L x W x H)	857 x 564 x 225 mm M models: 495 x 455 x 373 mm			1022 x 687 x 247 mm M models: 1022 x 687 x 247 mm
Approx. Net Weight	11.9 kg			18.1 kg
Approx. Shipping Weight	14.3 kg			22.2 kg

Model	i-D33XW150C1L5-EU	i-D33XW150C1X5-EU	i-D33XW300C1X5-EU
	i-D33XW150C1L5-GB	i-D33XW150C1X5-GB	i-D33XW300C1X5-GB
Capacity x Default Readability	150 kg x 20 g		300 kg x 50 g
Maximum Displayed Resolution	1:7,500		1:6,000
Linearity/Repeatability	±1d		
Certified Model	i-D33XW150C1L5EU-M	i-D33XW150C1X5EU-M	i-D33XW300C1X5EU-M
	i-D33XW150C1L5GB-M	i-D33XW150C1X5GB-M	i-D33XW300C1X5GB-M
Capacity x Certified/Approved Readability	150 kg x 50 g		300 kg x 100 g
Maximum Certified Resolution	1:3,000		
Indicator	304 stainless steel indicator		
Column	304 stainless steel front-mount bracket with handle		
Base Construction	Stainless steel removable weighing platform with stainless steel frame, silicon sealed IP67 stainless steel loadcell		
Safe Overload Capacity	150% of maximum capacity		
Stabilization Time	Within 1 second		
Operating Temperature Range	-10°C to 40°C		
Scale Dimensions (A x B x C x D x E x F)	550 x 420 x 134 x 80 x 132.9 x 842 mm	650 x 500 x 150 x 90 x 133 x 941 mm	
Shipping Dimensions (L x W x H)	1022 x 687 x 247 mm M models: 1022 x 687 x 247 mm		
Approx. Net Weight	18.1 kg	30.8 kg	
Approx. Shipping Weight	22.2 kg	34.3 kg	

DEFENDER™3000 Washdown Bench Scale

Specifications

Indicators

Model	i-DT33XW
Construction	304 stainless steel housing and mounting bracket
Protection	IP66
Weighing Units	Kilogram, Gram, Pound, Ounce: Ounce (Kilogram, Gram only for M models)
Application Modes	Weighing, Parts Counting, Checkweighing and Totalization
Display	6-digit, 7-segment LCD display with multi-color backlight, 45 mm high digits
Check Indicator	3 Color (red, green, yellow) backlight
Keyboard	4 function keys
Auto-zero Tracking	Off, 0.5 d, 1 d or 3 d
Zeroing Range	2% or 100% of capacity
Interface	RS232 included
	Optional USB, Ethernet
Power	100-240 VAC / 50/60 Hz Universal Power Supply, hardwired or standard rechargeable battery
Battery Life	Up to 100 hours continuous use with backlight off (rechargeable battery)
Calibration	Zero, Span or 3 point-Linear

Outline Dimensions

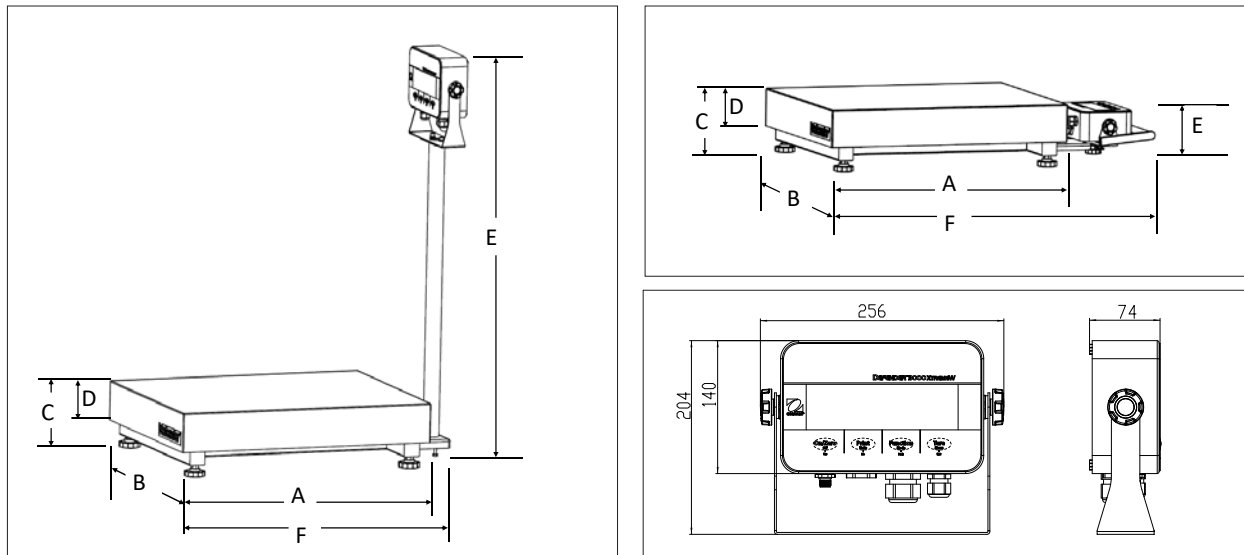

Compliance

- **Metrology:** EN45501 (Scale: T12209; Indicator: TC12208; Load Cell: OIML R60/2000-NL1-16.12 / TC8620).
- **Product Safety:** IEC/EN 61010-1; CAN/CSA C22.2 61010-1; UL61010-1
- **Electromagnetic Compatibility:** IEC/EN 61326-1 Class B, basic environments; FCC Part 15 Class A; Canada ICES-003 Class A
- **Ingress Protection:** IEC 60529 – IP66 (for indicator), IEC 60529 – IP67 (for load cell)
- **Compliance Marks:** CE, UKCA
- **Other:** WEEE, RoHS

Accessories

Ethernet Kit.....	30429666
USB Device Kit i-DT33.....	30699120
Dust Cover (5) i-DT33.....	30699121
Wheel Kit, Defender Series.....	30372146
Wheel Kit SST Defender Series.....	30616409
Carrying Handle Kit i-DT33.....	30696600
SF40A Printer.....	30064202
Cable RS232 i-DT33XW.....	80500552

Column Kit for i-DT33 indicator:

Column Kit, 330 mm, SST.....	30696595
Column Kit, 680 mm, SST.....	30696596
Column Kit, 330 mm, CS.....	30696597
Column Kit, 680 mm, CS.....	30696598
Column Kit, 980 mm, CS.....	30696599

OHAUS Europe GmbH

Heuwinkelstrasse 3,
8606 Nänikon,
Switzerland

e-mail: ssc@ohaus.com
Tel: 0041 22 567 53 19
e-mail: tsc@ohaus.com
Tel: 0041 22 567 53 20

www.ohaus.com

The management system
governing the manufacture of
this product is ISO 9001:2015
certified.