



RANGER® 7000
Terminal Tower Mount Kit
Instruction Manual

Manual de instrucciones
del kit de montaje de la torre del
terminal
de la RANGER® 7000

RANGER® 7000
Kit de montage du terminal sur
tourelle
Manuel d'instructions

RANGER® 7000
Säulenset zur Terminalmontage
Bedienungsanleitung

RANGER® 7000
Kit di montaggio della torretta
terminale
Instruction Manual

1. INTRODUCTION

Please read this manual completely before installation and operation.

CAUTION:



READ ALL SAFETY WARNINGS BEFORE INSTALLING, MAKING CONNECTIONS, OR SERVICING. FAILURE TO COMPLY WITH THESE WARNINGS COULD RESULT IN PERSONAL INJURY AND/OR PROPERTY DAMAGE. RETAIN ALL INSTRUCTIONS FOR FUTURE REFERENCE.

1.1 Kit Contents



2. INSTALLATION

2.1 Safety Precautions

For safe and dependable operation of this equipment, please comply with all safety precautions mentioned in this manual.

Disconnect equipment from mains power supply before installation.

2.2 Installation procedure

Follow the steps below. Refer to the Figures when performing the steps.

1



Make sure the unit is unplugged and turned OFF.



2

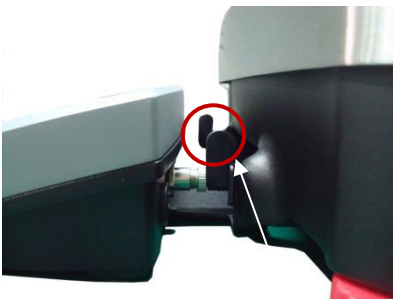

Detach the Terminal:
Push in one of the buttons on the side to disconnect. Then pull the Terminal away from the base.

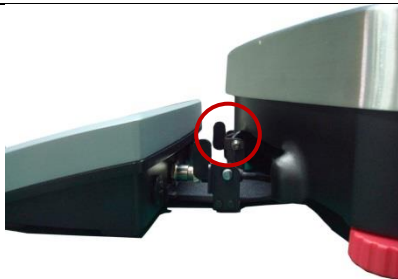

Disconnect the cable between the base and terminal

3

M5 screws

Remove the Joint plate from the Terminal by loosening the three M5 screws.

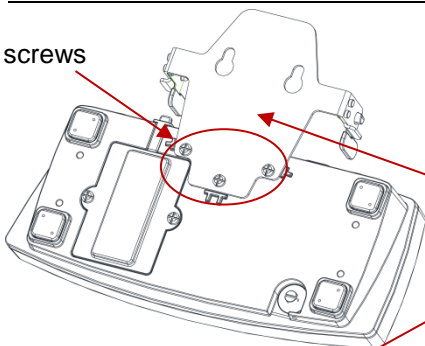

Joint Plate

M5 screws

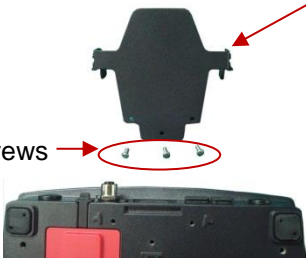

4



Unwind the Terminal cable from the base.

5

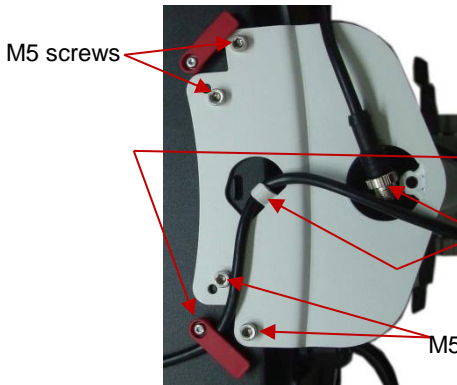

Attach Tower to the Base using the four M5 screws and hex wrench (supplied).

Secure the cable as shown:

1. First, under the cable guide,
2. Then under the groove in the tower base.

Insert the cable plug in the tower base and feed it through the column.

6



Pull the Terminal cable through the top of the column.

7

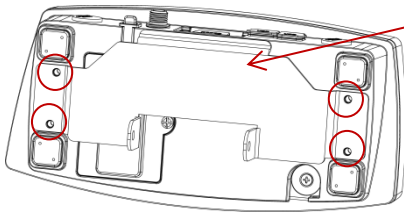

Install the joint plate on the back of the terminal, securing it with the 4 screws.

Tighten the screws.

8

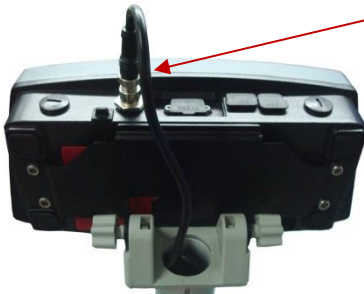

Plug in the cable to the Terminal, then rotate the screw and tighten it.

Pull excess cable down into the column for safety.

9



Adjust the Tower foot so it supports the Tower and is level with the feet of the Base.



To adjust the Terminal viewing angle:

- Loosen the knobs that secures the Tower top and adjust the Terminal.

3. KIT DIMENSIONS

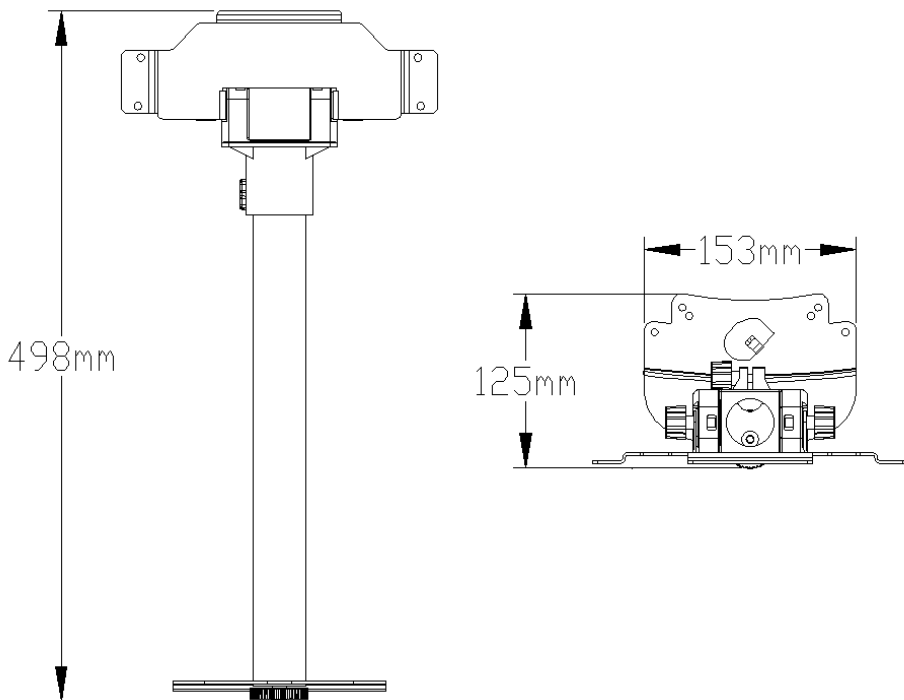
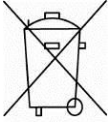

Figure 3-1. Tower kit dimensions

COMPLIANCE

Disposal



In conformance with the European Directive 2002/96 EC on Waste Electrical and Electronic Equipment (WEEE) this device may not be disposed of in domestic waste. This also applies to countries outside the EU, per their specific requirements. Please dispose of this product in accordance with local regulations at the collecting point specified for electrical and electronic equipment. If you have any questions, please contact the responsible authority or the distributor from which you purchased this device.

Should this device be passed on to other parties (for private or professional use), the content of this regulation must also be related.

For disposal instructions in Europe, refer to www.ohaus.com/weee.

Thank you for your contribution to environmental protection.

2. INSTALACIÓN

2.1 Precauciones de seguridad

Para un funcionamiento seguro y fiable de este equipo, cumpla con todas las precauciones de seguridad mencionadas en este manual.

Desconecte el equipo de la red antes de la instalación.

2.2 Procedimiento de instalación

Siga los siguientes pasos. Consulte las figuras al realizar los pasos.

1



Asegúrese de que la unidad está desenchufada y APAGADA.



2

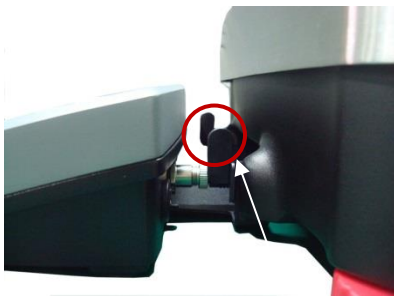

Separe el terminal.
Para desconectar, pulse uno de los botones en el lateral. Después separe el terminal de la base.

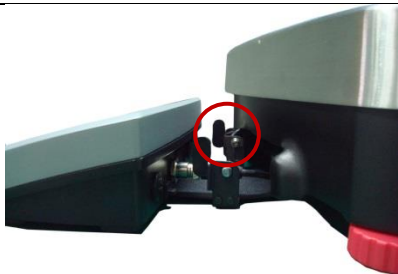

Desconecte el cable entre la base y el terminal

3

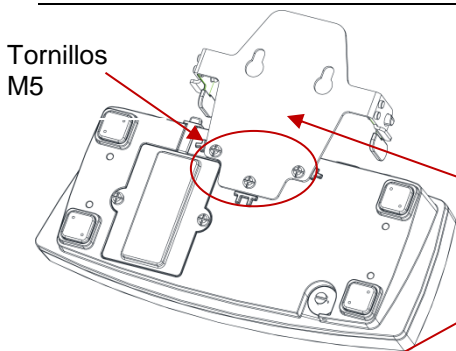

Retire la placa de unión del terminal aflojando los tres tornillos M5.

Placa de unión



Tornillos M5

4



Desenrolle el cable del terminal de la base.

5

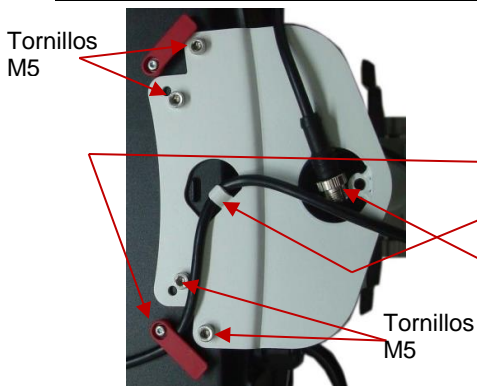

Coloque la torre en la base usando los 4 tornillos M5 y la llave hexagonal que se suministran.

Asegure el cable como se muestra.

1. Primero, debajo de la guía del cable.

2. Después debajo de la ranura en la base de la torre.

Inserte el enchufe del cable en la base de la torre e introdúzcalo a través de la columna.

6



Tire del cable del terminal a través de la parte superior de la columna.

7

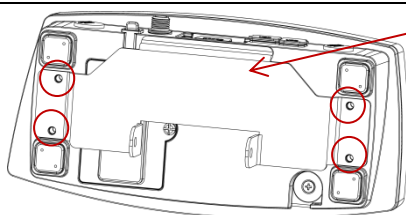

Instale la placa de unión en la parte posterior del terminal asegurándolo con 4 tornillos.

Apriete los tornillos.

8

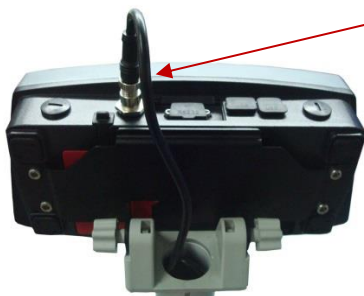

Enchufe el cable al terminal después rote y apriete el tornillo.

Para mayor seguridad, coloque el exceso de cable en la columna.

9



Ajuste el pie de la torre para que mantenga la torre y su nivel con el pie de la base.

10



Para ajustar el ángulo de visión del terminal:

- Afloje los botones que aseguran la parte superior de la torre y ajuste el terminal.

3. DIMENSIONES DEL KIT



Figura 3-1. Dimensiones del kit de la torre

CUMPLIMIENTO

Eliminación

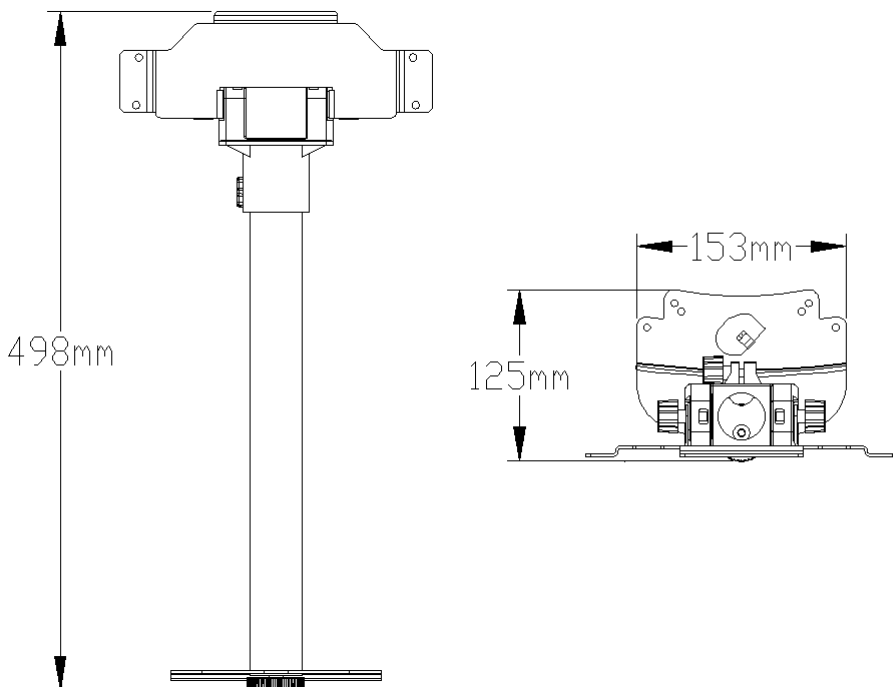

En cumplimiento con la Directiva europea 2002/96 de la CE sobre residuos de aparatos eléctricos y electrónicos (WEEE), este dispositivo no se puede eliminar como residuo doméstico. También se aplica en países fuera de la UE, según sus requisitos específicos.

Elimine este producto según las normativas locales en el punto de recolección especificado para equipos eléctricos y electrónicos. Si tiene alguna pregunta, póngase en contacto con la autoridad responsable o el distribuidor del que adquirió este dispositivo.

En caso de que este dispositivo se entregara a un tercero (para uso privado o profesional), se debe hacer referencia al contenido de esta regulación.

Para obtener instrucciones de eliminación en Europa, consulte www.ohaus.com/weee.

Gracias por su contribución a la protección del medioambiente.

1. INTRODUCTION

Lire complètement ce manuel avant l'installation et la mise en fonctionnement.

ATTENTION :



LIRE TOUS LES AVERTISSEMENTS DE SÉCURITÉ AVANT D'EFFECTUER L'INSTALLATION, LES CONNEXIONS OU LES RÉPARATIONS DE CET ÉQUIPEMENT. SI CES AVERTISSEMENTS NE SONT PAS RESPECTÉS, DES ACCIDENTS ET/OU DES DOMMAGES MATÉRIELS PEUVENT EN RÉSULTER. CONSERVER TOUTES LES INSTRUCTIONS POUR RÉFÉRENCE ULTÉRIEURE.

1.1 Contenu du kit



Huit Vis M5

Clé hexagonale

Haut de la tour
et pied

2. INSTALLATION

2.1 Précautions de sécurité

Pour une exploitation fiable et en toute sécurité de cet équipement, se conformer aux précautions de sécurité mentionnées dans le manuel.

Déconnecter l'équipement de l'alimentation secteur avant son installation.

2.2 Procédure d'installation

Suivre les étapes ci-dessous. Consulter les figures lors de la réalisation de ces étapes.

1



Vérifier que l'appareil est débranché et ÉTEINT.



2

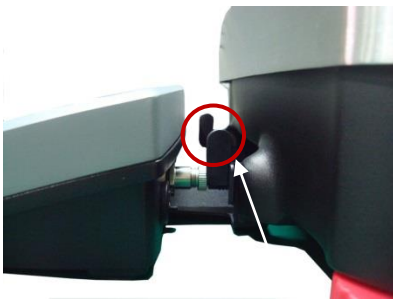

Détacher le terminal :
Appuyer sur l'un des boutons latéraux pour la déconnexion.
Extraire ensuite le terminal de la base.

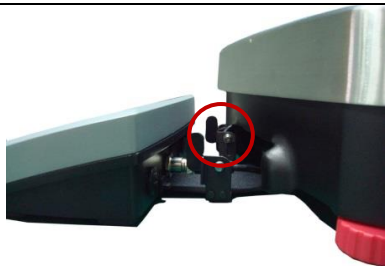

Déconnecter le câble entre la base et le terminal

3

Vis M5

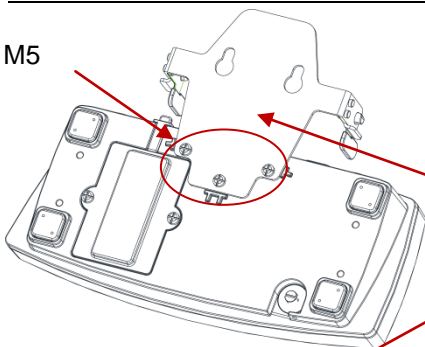

Démonter le couvre-joint du terminal en desserrant les trois vis M5.

Couvre-joint

Vis M5



4



Dérouler le câble du terminal hors de la base.

5

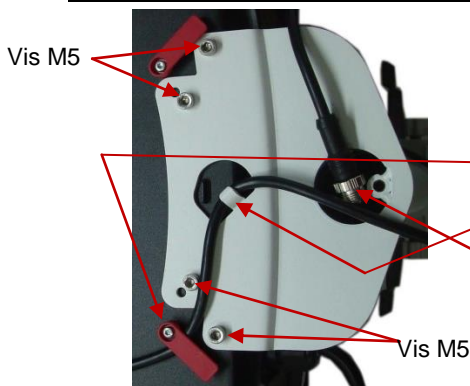

Fixer la tourelle sur la base en utilisant les quatre vis M5 et la clé hexagonale (fournie).

Fixer le câble selon la présentation :

1. D'abord sous le guide du câble,
2. et ensuite sous la rainure à la base de la tourelle.

Insérer la prise du câble dans la base de la tourelle et lui faire traverser la colonne.

6



Tirer sur le câble du terminal à travers la partie supérieure de la colonne.

7

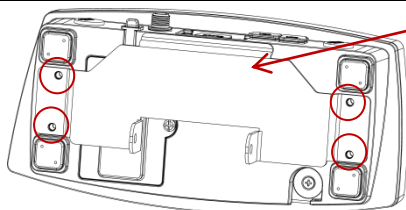

Installer le couvre-joint à l'arrière du terminal en le fixant avec les 4 vis.
Serrer les vis.

8

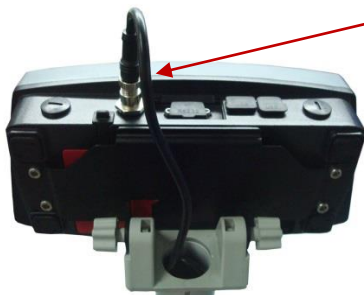

Brancher le câble sur le terminal,
visser la vis et la serrer.

Tirer le câble en excès vers le bas
dans la colonne par sécurité.

9



Ajuster le pied de la tourelle pour qu'il
puisse la soutenir ainsi que son niveau
avec le pied de la base.

10



Pour ajuster l'angle de visualisation du terminal :

- Desserrer les boutons maintenant la partie supérieure de la tourelle et régler le terminal.

3. DIMENSIONS DU KIT

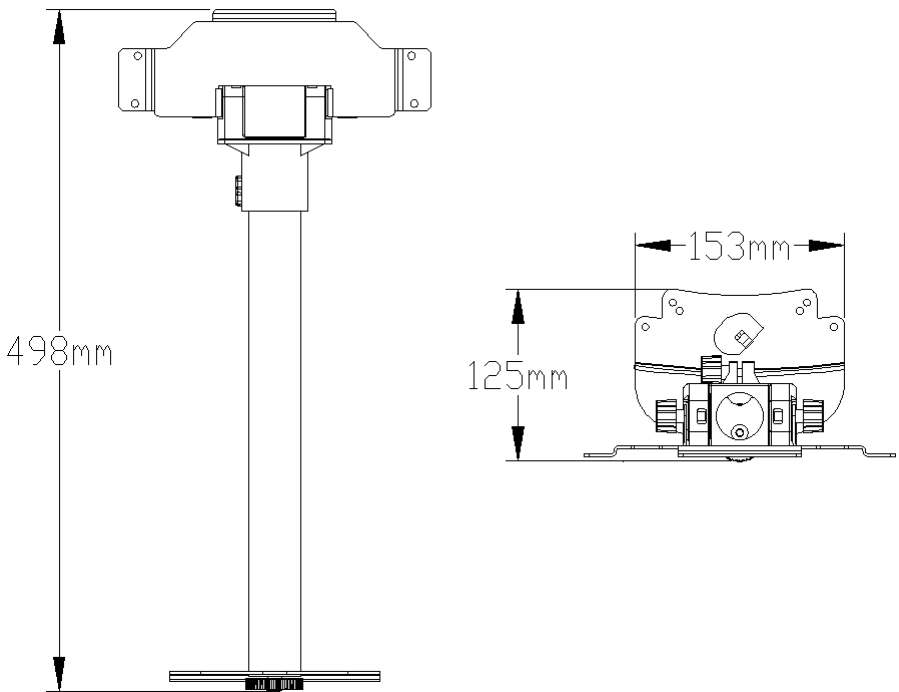

Figure 3-1. Dimensions du kit de la tourelle

CONFORMITE

Mise au rebut



Conformément à la directive européenne 2002/96/ CE sur l'équipement électronique et électrique des déchets (WEEE), cet appareil ne peut pas être éliminé dans des déchets ménagers. Ceci est également valable pour les pays en dehors de l'UE, selon leurs impératifs spécifiques.

Mette au rebut ce produit conformément à la réglementation locale au point de collecte spécifié pour les équipements électriques et électroniques. Pour de plus amples informations, contacter l'autorité responsable ou le distributeur auprès duquel vous avez acheté cet appareil.

Si cet appareil change de propriétaire (pour des raisons personnelles ou professionnelles), cette consigne doit lui être communiquée.

Pour les instructions sur la mise au rebut en Europe, voir www.ohaus.com/weee.

Merci de votre contribution à la protection de l'environnement.

1. EINLEITUNG

Lesen Sie diese Anleitung komplett durch, bevor Sie das Set installieren und verwenden.

ACHTUNG:



LESEN SIE ALLE SICHERHEITSHINWEISE, BEVOR SIE DAS SET INSTALLIEREN, ANSCHLIESSEN ODER REPARIEREN. DIE NICHTBEACHTUNG DER WARNHINWEISE KANN ZU VERLETZUNGEN UND/ODER BESCHÄDIGUNGEN FÜHREN. BEWAHREN SIE ALLE ANWEISUNGEN ZUM SPÄTEREN NACHSCHLAGEN AUF.

1.1 Set-Inhalt



2. INSTALLATION

2.1 Sicherheitsmaßnahmen

Zur sicheren und zuverlässigen Verwendung dieses Geräts müssen Sie alle Sicherheitsmaßnahmen in diesem Handbuch einhalten.

Trennen Sie die Waage vor der Installation vom Netz.

2.2 Installationsschritte

Führen Sie die folgenden Schritte durch. Beachten Sie dabei die Abbildungen.

1



Die Waage muss ausgeschaltet und vom Netz getrennt sein.



2

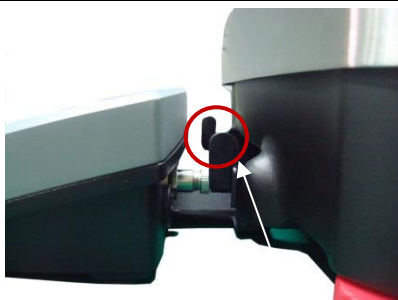

Lösen Sie das Terminal:
Drücken Sie auf eine der Freigabe-
tasten an der Seite, um das Terminal
vom Grundgerät zu trennen. Ziehen
Sie dann das Terminal vom
Grundgerät weg.

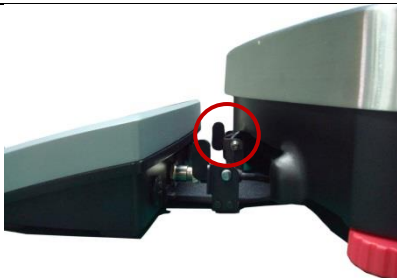

Trennen Sie das Kabel zwischen Grundgerät und Terminal.

3

Schrauben M5

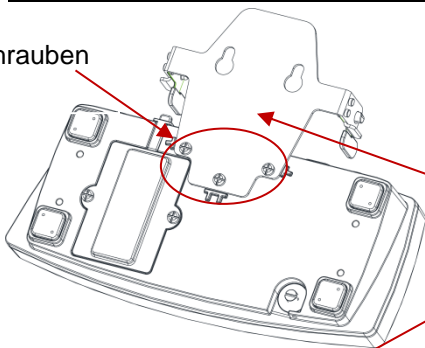

Entfernen Sie die Verbindungsplatte vom Terminal. Lösen Sie dazu die drei Schrauben M5.

Verbindungsplatte

Schrauben

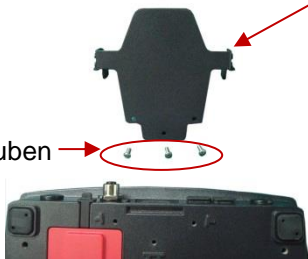

4



Wickeln Sie das Terminalkabel vom Grundgerät ab.

5

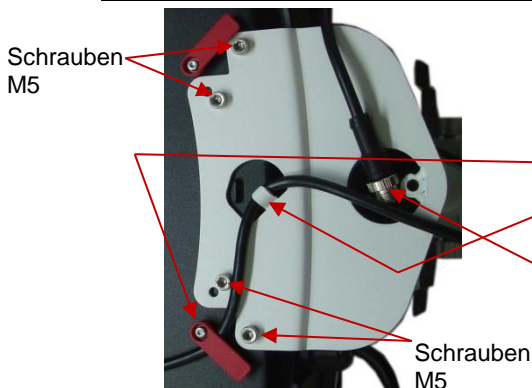

Befestigen Sie die Säule mit den vier Schrauben M5 und dem Inbus-schlüssel (im Lieferumfang enthalten) am Grundgerät.

Sichern Sie das Kabel wie abgebildet:

1. Zuerst unter der Kabelführung,
2. Dann unter der Kabelhalterung im Fuß der Säule.

Führen Sie das Kabel durch die Öffnung im Fuß der Säule und danach durch die Säule.

6



Ziehen Sie das Terminalkabel durch die obere Öffnung der Säule.

7

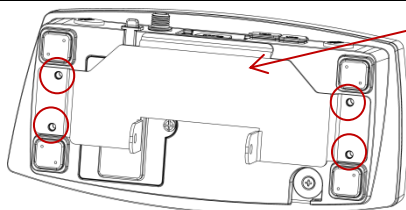

Befestigen Sie die Verbindungsplatte auf der Rückseite des Terminals mit 4 Schrauben.

Ziehen Sie die Schrauben fest.

8

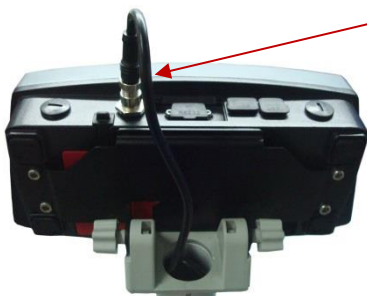

Verbinden Sie das Kabel mit dem Terminal und drehen Sie die Schraube fest.

Ziehen Sie überschüssiges Kabel aus Sicherheitsgründen zurück in die Säule.

9



Stellen Sie den Nivellierfuß der Säule auf die gleiche Höhe wie die Nivellierfüße des Grundgeräts ein, damit die Säule fest steht.

10

EINHALTUNG

Entsorgung

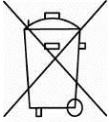

Entsprechend der Europäischen Richtlinie 2002/96/EG über Elektro- und Elektronik-Altgeräte (WEEE) darf dieses Gerät nicht im Hausmüll entsorgt werden. Dies gilt auch für Länder außerhalb der EU entsprechend den jeweiligen Vorschriften.

Entsorgen Sie dieses Produkt entsprechend den lokalen Vorschriften an der Sammelstelle für Elektro- und Elektronikgeräte. Bei Fragen wenden Sie sich bitte an die entsprechende Behörde oder an den Händler, von dem Sie das Gerät erworben haben.

Wenn Sie das Gerät an andere weitergeben (zur privaten oder beruflichen Nutzung), muss der Inhalt dieser Vorschriften ebenfalls weitergeben werden.

Entsorgungshinweise für Europa finden Sie unter www.ohaus.com/weee.

Vielen Dank für Ihren Beitrag zum Umweltschutz.

1. INTRODUZIONE

Leggere integralmente il manuale prima dell'installazione e della messa in funzione.

ATTENZIONE:



LEGGERE TUTTE LE AVVERTENZE DI SICUREZZA PRIMA DI PROCEDERE ALL'INSTALLAZIONE, ALLA REALIZZAZIONE DEI COLLEGAMENTI ALLA MANUTENZIONE. IL MANCATO RISPETTO DI QUESTA AVVERTENZA PUÒ COMPORTARE DANNI ALLA PROPRIETÀ E/O LESIONI PERSONALI. CONSERVARE TUTTE LE ISTRUZIONI PER RIFERIMENTI FUTURI.

1.1 Contenuto del kit

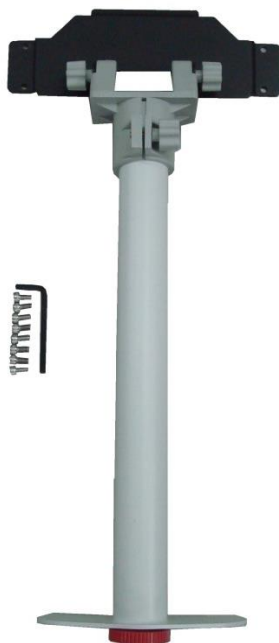

Otto viti M5

Chiave esagonale

Torretta con punta e piede

2. INSTALLAZIONE

2.1 Precauzioni di sicurezza

Per un funzionamento sicuro e affidabile dell'apparecchiatura, rispettare le precauzioni di sicurezza elencate nel presente manuale.

Scollegare l'apparecchio dall'alimentazione principale prima dell'installazione.

2.2 Procedura d'installazione

Seguire i passaggi descritti in basso. Fare riferimento alle figure quando si eseguono questi passaggi.

1



Assicurarsi che l'unità sia scollegata e spenta.



2

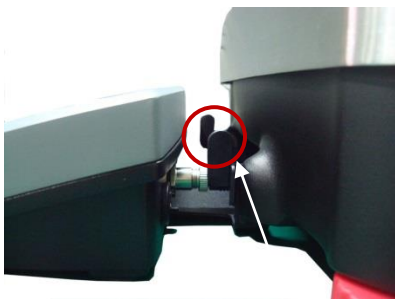

Staccare il terminale:
Spingere uno dei pulsanti a lato per scollegare. Quindi, separare il terminale dalla base.

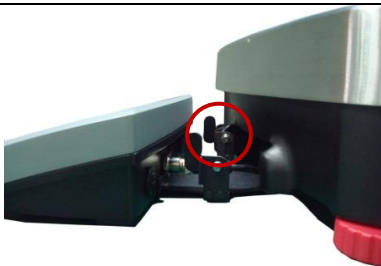

Scollegare il cavo tra la base e il terminale.

3

Rimuovere la piastra di giunzione dal terminale svitando le tre viti M5.

Viti M5

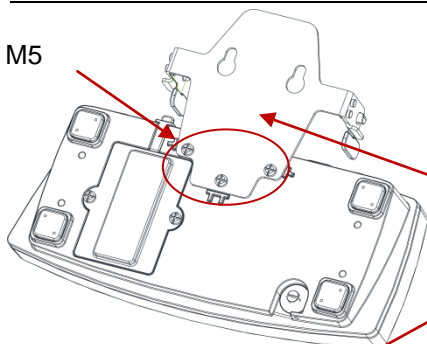

Piastra di giunzione

Viti M5

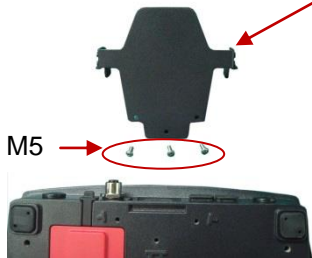

4



Svolgere il cavo del terminale dalla base.

5

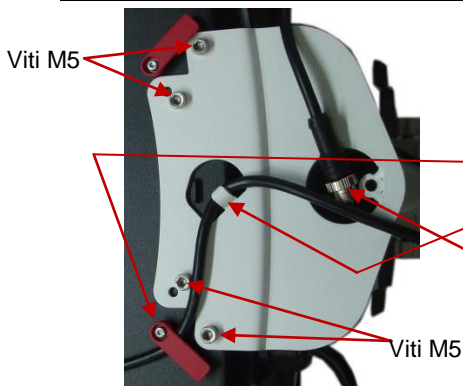

Fissare la Torretta alla base utilizzando le quattro viti M5 e la chiave esagonale (fornita).

Fissare il cavo come mostrato:

1. Dapprima, sotto la guida del cavo,
2. poi, sotto la scanalatura alla base della torretta.

Inserire la spina del cavo nella base della torretta e spingerla su per la colonna.

6



Spingere il cavo del terminale fino in cima alla colonna.

7

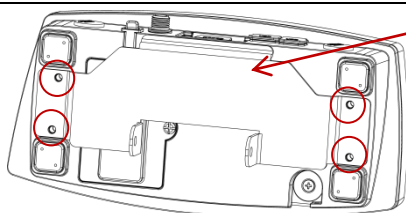

Installare la piastra di giunzione nella parte posteriore del terminale, fissandola con 4 viti.
Stringere le viti.

8

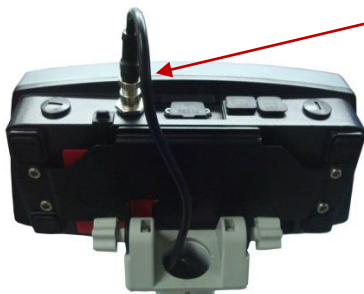

Inserire il cavo nel terminale, quindi avvitare e stringere le viti.

Spingere l'eccesso di cavo nella colonna, per sicurezza.

9



Regolare il piede della torretta in modo che la sostenga e che sia a livello con il piede della base.



Per regolare l'angolo di visione del terminale:

- Allentare le manopole che tengono ferma la cima della torretta e regolare il terminale.

3. DIMENSIONI KIT



Figura 3-1. Dimensioni Kit torretta

CONFORMITÀ

Smaltimento

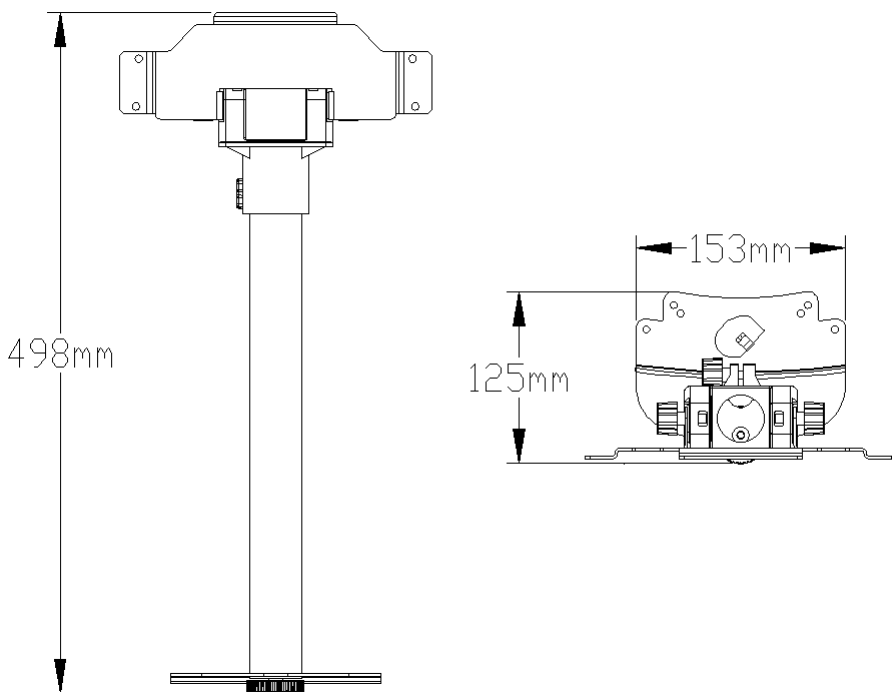

In conformità alla Direttiva Europea 2002/96/ CE sullo smaltimento delle apparecchiature elettriche ed elettroniche (WEEE, Waste Electrical and Electronic Equipment), l'apparecchiatura non deve essere smaltita assieme ad altri rifiuti domestici. La direttiva è applicabile anche a paesi non facenti parte dell'Unione Europea, in base ai requisiti specifici del paese di appartenenza. Il prodotto deve essere smaltito in base a quanto stabilito dalle normative locali presso il punto di raccolta specifico per apparecchiature elettriche ed elettroniche. Per eventuali domande, contattare l'autorità responsabile o il distributore da cui è stato acquistato l'apparecchio.

Qualora l'apparecchio venga trasferito a terzi (per uso privato o professionale), il contenuto della presente normativa deve ritenersi valido anche per terzi.

Per le istruzioni relative allo smaltimento in Europa, fare riferimento a www.ohaus.com/weee.

Grazie per il contributo alla salvaguardia dell'ambiente.



Ohaus Corporation
7 Campus Drive
Suite 310
Parsippany, NJ 07054, USA
Tel: +1 973 377-9000
Fax: +1 973 944-7177

With offices worldwide / Con oficinas en todo el mundo / Avec des bureaux dans le monde entier / Mit weltweiten Niederlassungen / Con uffici in tutto il mondo

www.ohaus.com



* 3 0 0 9 5 4 4 2 *

P/N 30095442A © 2013 Ohaus Corporation, all rights reserved / todos los derechos reservados / tous droits réservés / Alle Rechte vorbehalten / tutti i diritti riservati.

Printed in China / Impreso en China / Imprimé en Chine / Gedruckt in China / Stampato in Cina