MANUAL ERT DYNALINK

With optional remote display



TABLE OF CONTENTS

SAFE OPERATION GUIDE	2
CHAPTER 1 FEATURES AND SPECIFICATION	3
1.Features.....	3
2.Main technical data.....	3
3.Specification.....	3
4.Appearance illustration.....	4
5.Power supply.....	4
CHAPTER 2 DISPLAY AND KEY	5
1. Led display.....	5
2. Key area.....	5
CHAPTER 3 WIRELESS INDICATOR OPERATION GUIDE	7
CHAPTER 4 DYNA LINK FUNCTION GUIDE	8
1.Turn on/off.....	8
2.Zero.....	9
3.Tare.....	9
4.Peak Hold.....	9
5.Accumulation.....	9
6.Accumulation Search.....	9
7.Accumulation Clear.....	9
8.Battery Voltage Check.....	10
9.Unit Convert.....	10
CHAPTER 5 PARAMETER SETTING & CALIBRATION	10
1. Parameter setting.....	10
2. calibration.....	13
CHAPTER 6 SIGNAL ILLUSTRATION	14
CHAPTER 7 TROUBLESHOOTING GUIDE	15

FE OPERATION GUIDE :

1. Do not overload this Dyna-link load guage.
2. Do not perform overhead weighing. Stay clear when Dyna-link load guage is in operation
3. Do not perform weighing under strong wind condition which may cause incorrect reading
4. Do not perform weighing under enviornment of temperature rapid changes in which may cause incorrect reading
5. Do not attempt to open this Dyna-link load guage, no user serviceable parts inside.
6. Do not remove wire rope stopper from hook. For safety reasons, always apply it.
7. Remove all loads from shackle or hook when not in used.
8. Before weighing, check and make sure that all hanging /load- receiving elements / devices are in good condition.
9. Check hook, shackle, safety pins, and latches periodically. Contact your dealer for parts replacement in case defect, deform or wearing is found.
10. Always lift loads vertically.

CHAPTER 1 FEATURES AND SPECIFICATION

Profile:

ERT wireless Dyna-link load guage is an extremely well-built instrument for industry use ,as a standard wireless tool offer universal applications,Whether used as conventional crane weigher or to measure force, ERT wireless Dyna-link load guage is microprocessor controlled for precision accuracy, calibration is easier with wireless indicator.

1. Standard Features:

- ◆ Rugged construction.
- ◆ Accuracy: 0.1% of capacity
- ◆ All fuctions and units are clearly display on the LCD (with backlighting),
- ◆ Digits are 1 inch high for easy distant viewing.
- ◆ Two user programmable Set-Point can be used for safety and warning applications or for limit weighing.
- ◆ Long battery life on 3 standard "LR6(AA)"size alkaline batteries.
- ◆ All commonly used internationally recognized units are available:kilograms(kg), short Tons(t) pounds(lb), Newton and kilonewton(kN)
- ◆ Infrared Remote control easier to calibration(with password)
- ◆ Infrared Remote control with many fuctions: "ZERO", "TARE", "CLEAR", "PEAK", "ACCUMULATE", "HOLD", "Unit Change", "Voltage Check" and "Power OFF"
- ◆ 4 local mechanical keys:"ON/OFF", "ZERO", "PEAK" and "Unit Change".
- ◆ low battery warnning.
- ◆ RF wireless palm indicato

2. Main technical data

Display	25mm (1") 5digits LCD
Power on zero range	20% F.S.
Manual Zero Range	4% F.S.
Tare Range	20% F.S.
Stable Time	≤10 seconds
Overload Indication	100% F.S. + 9e
Max. Safety Load	125% F.S.
Ultimate Load	400% F.S.
Battery Life	≥40 hours
Battery Type	"LR6(AA)"size alkaline batteries. 1.5V x 3
Operating Temp.	- 10°C ~ + 40°C
Operating Humidity	≤85% RH under 20°C
Wireless Distance	Min. 80m(default) [200m(optional)]
Wireless Frequency	2.4GHz(default),433MHz,860MHz(optional)

3.Specification

MODEL	Max. capacity (kg/lb)	Min. weigh (kg/lb)	Division (kg/lb)	Total display
ERT -01	1000 /2200	10	0.5	n=2000
ERT -02	2000 /4400	20/4	1	n=2000
ERT -03	3000 /6600	20/4	1	n=3000
ERT -05	5000 /11000	40/8	2/	n=2500
ERT -10	10000 /22000	100/200	5	n=2000
ERT -15	15000 /33000	100/200	5/1	n=3000
ERT -20	20000 /44000	200 /400	10/2	n=2000
ERT -30	30000/66000	200/400	10/2	n=3000
ERT -50	50000/110000	400/800	20/4	n=2500
ERT -100	100000/220000	1000/2000	50/100	n=2000
ERT -200	200000/440000	20000/4000	100/200	n=2000

4. Appearance illustration

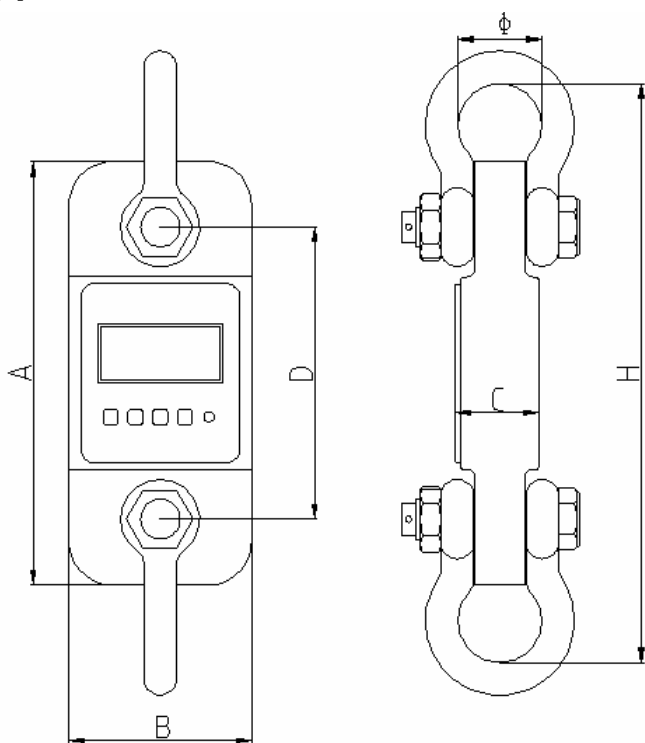

CAPACITY	A(mm)	B(mm)	C(mm)	D(mm)	Ø(mm)	H(mm)	MATERIAL
1000kg	245	112	37	190	43	335	Aluminium
2000kg	245	116	37	190	43	335	Aluminium
3000kg	260	123	37	195	51	365	Aluminium
5000kg	285	123	57	210	58	405	Aluminium
10000kg	320	120	57	230	92	535	Steel
15000kg	375	128	74	260	127	660	Steel
20000kg	375	128	74	260	127	660	Steel
30000kg	420	138	82	280	146	740	Steel
50000kg	465	150	104	305	184	930	Steel
100000kg	570	190	132	360	229	1230	Steel
200000kg	725	265	183	440	280	1380	Steel

5. Power supply

Battery: "LR6(AA)"size alkaline batteries. 1.5V x 3



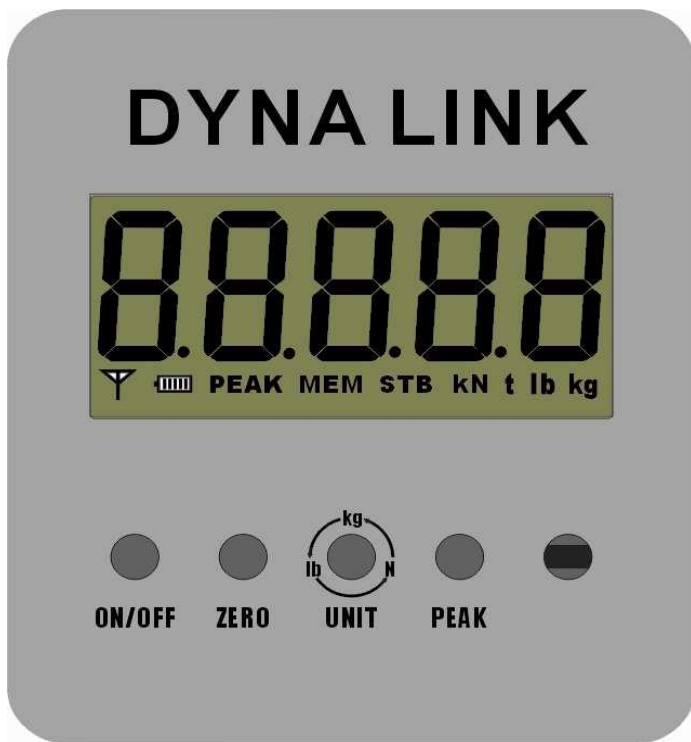

Current: the Dyna-link load gauge average current is about DC 25mA, 3pcs new batteries can be used for about 50hours.wireless indicator average current is about DC 20mA, 4pcs new batteries can be used for about 80hours

Low battery warning: When the digits flashes, it means the battery needs to be replaced. The Dyna-link load gauge or wireless indicator will power off automatically after half hours operation.

CHAPTER 2 DISPLAY & KEY



1. LCD DISPLAY

- a. 25mm (1") 5digits LCD with all fuctions and units.
- b.  : Wireless signal, it Appear means signal stable, it disppear while signal miss. it flash means signal weak.
- c.  : Battery Voltage,  : Full,  : Low,  : Empty
- d. **PEAK** : Current value is Peak Hold value(maxmium value).
- e. **MEM** : Appear one time when Parameter or calibration value storage. long time appearance means current value is Accumulation data.
- f. **STB** : Stable Status.
- g. **kN** : "kilonewton", **N** : "Newton". Tare status "N" will flash.
- h. **t** : "ton".
- i. **lb** : "pound".
- j. **kg** : "kilogram".

2. Key Area

- a. **ON/OFF**: Power ON & Power OFF
 1. Press "**ON/OFF**" Key 3 Second, the Dyna-link load guage turn ON.
 2. In ON status, Press "**ON/OFF**" Key 1 Second, the Dyna-link load guage turn OFF.

b. ZERO:

When DYNA LINK load guage switch on with no load on the hook, but there are small digits on screen, press this key to obtain the zero reading.

c. UNIT:

Press UNIT key, the unit on LCD will circlely sequence change: “kg”→ “t”→ “lb” →“klb”→ “N” → “k N” → “kg” .

d. PEAK:

- ① · When weight is changing · press this key will display the maximum reading.
- ② · Press this key again · reading will resume changing.

CHAPTER3

WIRELESS INDICATOR OPERATION GUIDE



① · **【 ZERO 】**

- a. In testing status ,there are small digits on screen, press this key to obtain the zero reading.
- b. In Parameter Setting status · it Used as scrolling up.

② · **【 TARE 】:**

- a. Hang sling or container on the hook, when the reading stable, press this key, the digits display “0”, and “N” indicator Flash.
- b · Put the goods into container, the DYNA LINK will display goods net weight.
- c · If move goods and container, the DYNA LINK will display minus value of tare weight.
- d. In Parameter Setting status · it Used as digits movement ◦

③ · **【 MODE 】 :**

Used as function select · or can be combined with other Keys.

④ · **【 ENTER 】 :**

- ◆ Used as function select , normally combined with 【MODE】 Key.
 - ◆ Press 【MODE】 key once, display “OFF”, Press 【ENTER】 Key to realize remote power OFF .
 - ◆ Press 【MODE】 key twice, display “SETUP”, Press 【ENTER】 Key access Parameter Setting status. Setting finish, press 【MODE】 key again storage data and back to test mode.
 - ◆ Press 【MODE】 key 3 times, display “dC”, Press 【ENTER】 Key to inquire battery voltage, press 【MODE】 key again back to test mode.
 - ◆ Press 【MODE】 key 4 times, display “Unit”, Press 【ENTER】 Key access unit selection. Press 【ZERO】 key to select unit, press 【MODE】 key again back to test mode.
 - ◆ Press 【MODE】 key 5 times, display “ACCU”, Press 【ENTER】 Key access Accumulation Status, press 【MODE】 key again back to test mode.
 - ◆ Press 【MODE】 key 6 times, display “SACCU”, Press 【ENTER】 Key access Accumulation Search Status, press 【MODE】 key again back to test mode.
 - ◆ Press 【MODE】 key 7 times, display “cLEAR”, Press 【ENTER】 Key access Accumulation clear Status, display “CLr”, Press 【ENTER】 Key again, display “noCLr”. press 【MODE】 key again back to test mode.
 - ◆ Press 【MODE】 key 8 times, display “CLIBr”, Press 【ENTER】 Key 3 seconds, access calibration Status, if press 【ENTER】 key less than 3 seconds, it will back to test mode.
 - ◆ Press 【MODE】 key 9 times, display “dFuLt”, Press 【ENTER】 Key and 【PEAK】 Key 3 seconds back to default setting.
- ⑤ · 【PEAK】
- ① · When weight is changing , press this key will display the maximum reading.
 - ② · Press this key again , reading will resume changing.

CHAPTER 4 DYNA LINK FUNCTION GUIDE.

Note : () mean the key on overlay , 【 】 mean the key on wireless indicator

1. ON/OFF

◆TURN ON Press (ON/OFF) 3seconds , display as below :

OPERATION	DISPLAY	ILLUSTRATION
ON/OFF	【8.8.8.8.8.】	Display twice
	【 Ert 】	Display twice
	【1000.0】	Display twice capacity
	【U 6.XX】	Display current battery voltage
	【u 2.1】	Display current software version
	【-----】	Waiting stable
	【 O】	“STB”light on, you can operate now

◆TURN OFF

1	Manual Power	Press (ON/OFF) Key 3Seconds
2	Remote Power OFF	Press 【MODE】 Key select “OFF”,press 【ENTER】 Key
3	Auto Power OFF	Choose turn off method when parameter setting, the scale will display [-] after no operation at 15minutes to save power,and it will turn off automatically after 60minutes.

2.ZERO

	OPERATION	DISPLAY	When Dynalink turn on,generally it displays [0] ,if display small digits when no load, press this key.
1	Press (ZERO	[0]	
2	Press 【ZERO		

3.TARE

	OPERATION	DISPLAY	After turn on,hanging tare weight such as sling, cable at first, press this key, “TARE” light on,then the scale will display net weight of the goods.
1	Press 【TARE】	[0]	

4.PEAK HOLD

	OPERATI	ILLUSTRATION
	Press (PEAK)or 【PEAK】	Display Maximum value
	Press (PEAK)or 【PEAK】 again	reading will resume changing.

5.ACCUMULATION

OPERATION	DISPLAY	ILLUSTRATION
Press 【MODE】 key5 times Then Press 【ENTER】	[No***]	Current accumulation time
	[H****]	Front four digits of total value
	[L****]	Rear four digits of total value

After display above contents twice, the DYNA LINK will return automatically.

6 · ACCUMULATION SEARCH

OPERATION	DISPLAY	ILLUSTRATION
Press 【MODE】 key 6 times Then Press 【ENTER】	[No.***]	Current accumulation time
	[*****]	Current weight reading
	[H****]	Front four digits of total value
	[L****]	Rear four digits of total value
Press 【MODE】 key		Return

Press 【TARE】 and 【ZERO】 can check different times weight and accumulation.

7. ACCUMULATION CLEAR

OPERATION	DISPLAY	ILLUSTRATION
Press【MODE】key 7 times Then Press 【ENTER】 Key	〔 CLr 〕	Ask if you want to clear or not
	〔noCLr〕	Press 【MODE】 key Cancel clear
	〔8.8.8.8.〕	Press 【ENTER】 key Confirm clear

8. BATTERY VOLTAGE

OPERATIO	DISPLAY	ILLUSTRATION
Press 【MODE】 key 3 times, display“dC”,press 【ENTER】key.	〔U *.*〕	Display current battery voltage
Press 【MODE】 key again		Return

Note : Battery voltage normally between 〔U 3.50〕 to 〔U 4.70〕 ,if below 〔U 3.10〕 , display will flash , Battery should be changed.

9. UNIT CONVERT

OPERATION	DISPLAY	ILLUSTRATION
Press 【MODE】 key select “UnIt”, press 【ENTER】 key.	〔Un =00〕	press 【ENTER】 key,Unit will be changed circulate
Press 【MODE】 key again		Return

10. Return to normal tecting status

OPERATI	DISPLAY	ILLUSTRATION
Press 【MODE】 keyselect “ESC”, press 【ENTER】 key.		Return to normal tecting status

HAPTER 5 PARAMETER SETTING & CALIBRATION.

You can use wireless indicator to operate parameter setting and calibration

1.Key function:

KE	FUNCTION
【TARE】	Move digits
【ZERO】	Set value up
【MODE】	Storage and exit
【ENTER】	Confirm

2. PARAMETER SETTING

OPERATION	DISPLAY	ILLUSTRATION
Press 【MODE】 two times	〔SETUP〕	Confirm, enter parameter setting program
Press 【ENTER】	〔FS=06〕	New Dyna-link , the screen display FS=06 , if

OPERATION	DISPLAY	ILLUSTRATION
Press 【ZERO】 to choose	〔FS=02〕	Choose capacity , the screen display 02/03/05/06/10/15/20/30/50/60/75 circularly , take cap:2000kg as example, choose FS=02
Press 【ENTER】 to confirm	〔Id=02〕	New Dyna-link , the screen display Id=02, if dyna-link calibrated , the screen display calibrated division.
Press 【ZERO】 to choose	〔Id=01〕	Choose division , the screen display 01/02/05/10/20 circularly. 2000kg Dyna-link division is 1kg, so choose Id=01
	〔Pt=0〕	New Dyna-link , the screen display Pt=0, if Dyna-link calibrated , the screen display calibrated decimal position
Press 【ZERO】 to choose	〔Pt=0〕	Choose decimal position, the screen display 0/1/2/3 circularly, 0=xxxxx, 1=xxxx.x, 2=xxx.xx, 3=xx.xxx , Cap.2000kg Dyna-link
Press 【ENTER】 to confirm	〔Ab=24〕	Display zero range , A:zero range by hand;B:zero range automatically, 0~5 total 6 options: 0=0%F.S; 1=2%F.S; 2=4%F.S; 3=10%F.S; 4=20%F.S; 5=50%F.S Generally Don't change this
Press 【ENTER】 to confirm	〔Cd=11〕	New Dyna-link , the screen display Cd=11,if Dyna-link calibrated , the screen display calibrated value.
Press 【ZERO】 to confirm	〔Cd=11〕	C: zero-tracking range, 0~5 total 6 options; 0=0d; 1=0.5d; 2=1d; 3=1.5d; 4=2d; 5=2.5d d: display speed , 0~2 total 3 options; 0=slow; 1=average; 2=fast; before calibration,set Cd=00,after calibration, set Cd=11 again. generally choose Cd==11
Press 【ENTER】 to confirm	〔LL=2〕	New Dyna-link , the screen display LL=2, if dyna-link calibrated , the screen display calibrated value.
Press 【ZERO】 to choose	〔LL=2〕	LL : filter parameter , 0~5 total 6 options , from smallest to biggest , before calibration, set LL=0,after calibration, set LL=2 again,

Press【ENTER】to confirm	〔Un=0〕	New dyna-link , the screen display Un=0, if dyna-link calibrated , the screen display calibrated unit.
Press 【ZERO】 to choose	〔Un=0〕	Choose unit , Un=0 : kg, Un=1: lb, Un=2: N, Un=3: KN, Un=4: ton, Generally, choose Un=0 when ex-stock.
Press【ENTER】to confirm	〔OFF 1〕	New dyna-link , the screen display OFF 1, if dyna-link calibrated , the screen display calibrated value.
Press 【ZERO】 to choose	〔OFF 2〕	Choose turn off method, 0~2 total 3 options; 0: turn off by hand; 1: if no operation, the screen display [-] after 15minutes to save power;2: if no operation, the screen display [-] after 15minutes, and turn off automatically after 60minutes. Generally,
Press【ENTER】to	〔 SP1〕	Set point 1
Press【ENTER】to confirm	〔1 OFF〕	New dyna-link , the screen display 1 OFF, if dyna-link calibrated , the screen display calibrated value.
Press 【ZERO】 to choose	〔1 LO〕	Choose Set point 1 mode: “1 OFF” means set point 1 no function, “1 LO” is Set point 1 lower, “1 HI” is Set point 1
Press 【ENTER】 confirm	〔02000〕	New dyna-link , the screen display 02000, if dyna-link calibrated , the screen display
Press 【ZERO】 to set value, Press 【TARE】 to move digit	〔02000〕	Set “1 LO” or “1 HI” Value.
Press【ENTER】to	〔 SP2〕	Set point 2
Press【ENTER】to confirm	〔2 OFF〕	New dyna-link , the screen display 2 OFF, if dyna-link calibrated , the screen display calibrated value.
Press 【ZERO】 to choose	〔2 LO〕	Choose Set point 2 mode: “2 OFF” means set point 2 no function, “2LO” is Set point 1 low value, “2 HI” is Set point 2 High value
Press 【TARE】 to confirm	〔02000〕	New dyna-link , the screen display 02000, if dyna-link calibrated , the screen display calibrated value.

Press 【ZERO】 to set value, Press 【TARE】 to move digit	〔02000〕	Set “2 LO” or “2 HI” Value.
Press【ENTER】 to	〔 g〕	acceleration of gravity
Press【ENTER】 to confirm	〔9.7940〕	New dyna-link , the screen display 9.7930, if dyna-link calibrated , the screen display calibrated value.
Press 【MODE】	〔 End 〕	Confirm above parameter setting , Exit parameter

3. calibration

OPERATION	DISPLAY	ILLUSTRATION
	〔 0〕	Take Cap:2000kg Dyna-link as example , pay attention that the screen display 〔 0 〕 after hanging tare weight, you can hang tare weight at first then turn on
Press 【MODE】 key 8 times,display“CLIBr” Press 【ENTER】 Key 3 seconds,access calibration Status	〔LoAd 〕	No load , the screen display 0,and wait until STB display
Hanging standard weight 2000kg		Waiting until STB signal on screen
Press 【ENTER】 Key	〔02000 〕	Display capacity you choose when parameter setting , and first digit flash , Do wait until STB signal on screen.
Press 【MODE】 key to storage	〔-----〕	Confirm
	〔 -oL- 〕	
	〔End〕	
	〔2000.0〕	
Press 【TARE】 key to Shift digit	〔2000〕	Calibration end

CHAPTER 6 DISPLAY ILLUSTRATION

DISPLAY	ILLUSTRATION	REMARK
〔no519〕	Without wiresee signal	
〔SEtUP〕	Enter parameter setting	
〔UAdJ 〕	Enter voltage calibration	
〔LoAd〕	Calibration point	
〔- - - - 〕	Exceed high limit	Tare weight can't exceed full
〔 ____ 〕	Exceed low limit	Tare weight can't be negative
〔-----〕	Waiting	
〔Err10〕	Weight less than Min.	Can't accumulate the value
〔Err11〕	Accumulated times	Can't accumulate after 30times
〔Err12〕	Accumulated weight	Can't accumulate after 99999
〔Err13〕	Error in repeat accumulation	Can't accumulate one weight
〔no***〕	Current accumulation times	
〔H****〕	Front four digit of accumulated weight	Total weight=front four digit + rare four digit
〔L****〕	Rare four digit of accumulated weight	Total weight=front four digit + rare four digit
〔 CLr 〕	Ask if you really want to delete accumulated weight	In case error deletion
〔noCLr〕	Give up deletion	
〔88888〕	Confirm deletion	
〔 - - - 〕	Input value is too large	When you input tare or weight
〔 ____ 〕	Input value is too small	When you input tare or weight
〔noACC〕	No any accumulated	when you check accumulation
〔-oL0- 〕	Overload warning	Tare + Net weight exceed full
〔-oL1- 〕	Overload warning	Tare + Net weight exceed full
〔-Lb- 〕	Low battery warning	Turn off automatically one minute
〔U*.**〕	The voltage of current	
〔 End 〕	End	when parameter setting or
〔 OFF 〕	Turn off	
〔Unstb〕	Input value before STB light	

NOTE: If you turn off the DYNA-LINK ,immediately turn on it , sometime it will disply 〔-oL1- 〕 though it without any hanging. Just turn off it waiting few minutes.

CHAPTER 7 TROUBLESHOOTING GUIDE

PROBLEM	POSSIBLE CAUSE	SOLUTION
No display	Defective battery	Replace
	Defective button	Requires authorized service
	Power button not properly depressed	Press ON/OFF key firmly in three seconds
Digits flash	Low battery	Recharge the battery
Display doesn't respond to load changes	Faulty loadcell or PCB	Requires authorized service
	Out of calibration	Re- calibration
Display experiences excessive	DYNA LINK do not stabilize after turning on	After turning on, heating 3-5 minutes.
Displayed weight shows large error	DYNA LINK not Zeroed before	Depress ZERO before applying
	Requires recalibration	See calibration
	Kg/lb wrong selection	See operation
Wireless distance shortened	Wireless indicator's battery is low	Replace battery.