

DGT4XAN

Digital weight Transmitter with 4 channels

QUICK START GUIDE V1

ENGLISH

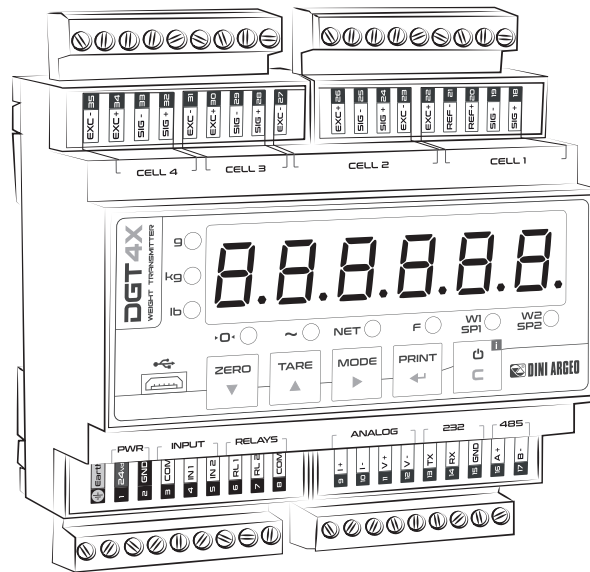

1. Electrical scheme

⚠ In LOAD CELL 2, 3, 4 connect:
SEN + to EXC +
SEN - to EXC -

⚠ There's a single SENSE circuit that compensate all 4 load cells.

⚠ Load cells excitation: 5 V.
Load cells output: 6 mV/V max.

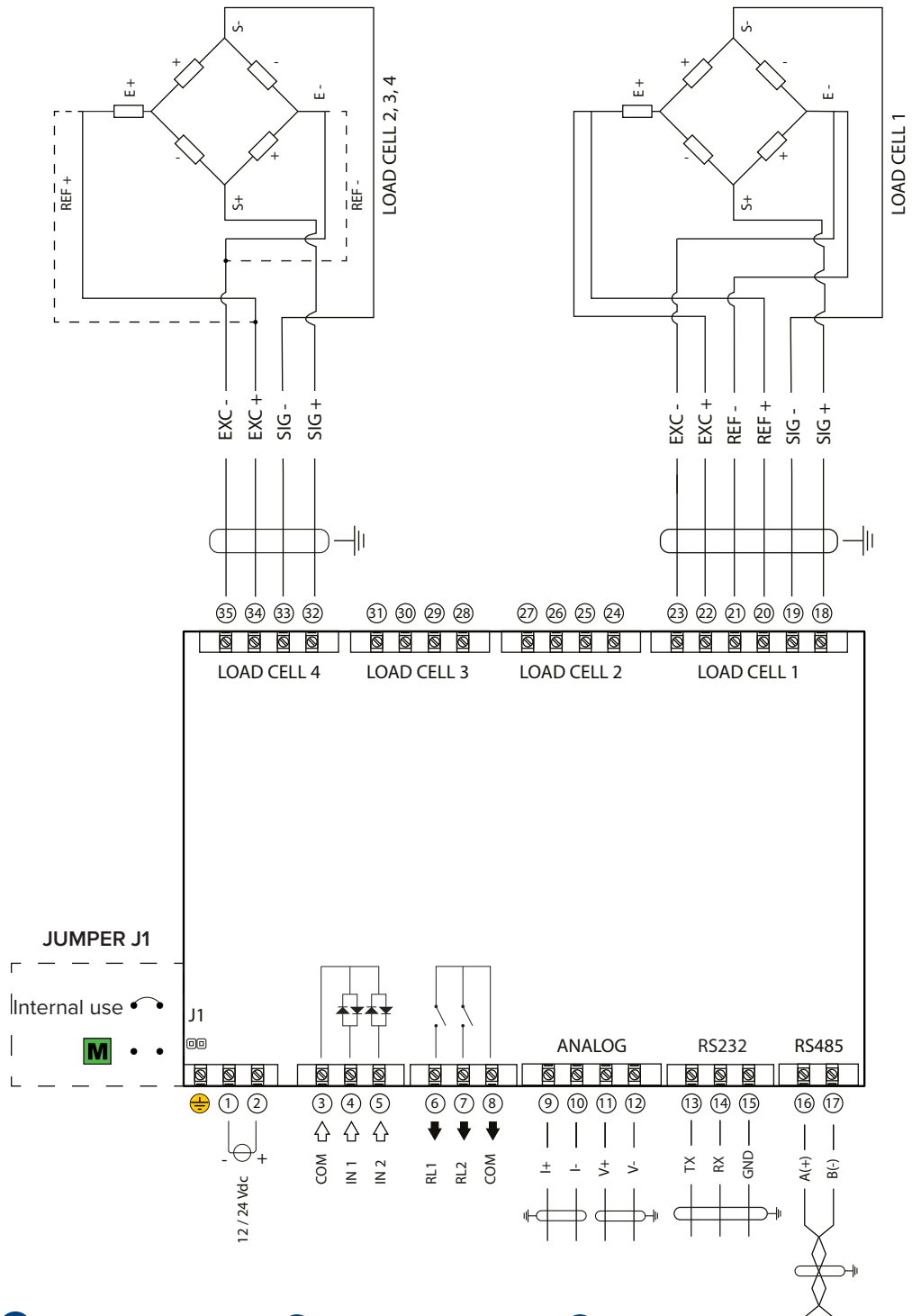

UL For UL approved models: equipment to be powered by 12-24 Vdc LPS or Class 2 power source.

⚠ CONSUMPTION:
4,5 W max.

⚠ INPUT:
12÷48 Vdc,
OUTPUT:
48Vac or 60Vdc,
0,5 A max

⚠ Max resistance on current analog output: 300 Ω
Min resistance on voltage analog output: 1 kΩ

2. Key function in configuration menu and in weighing mode

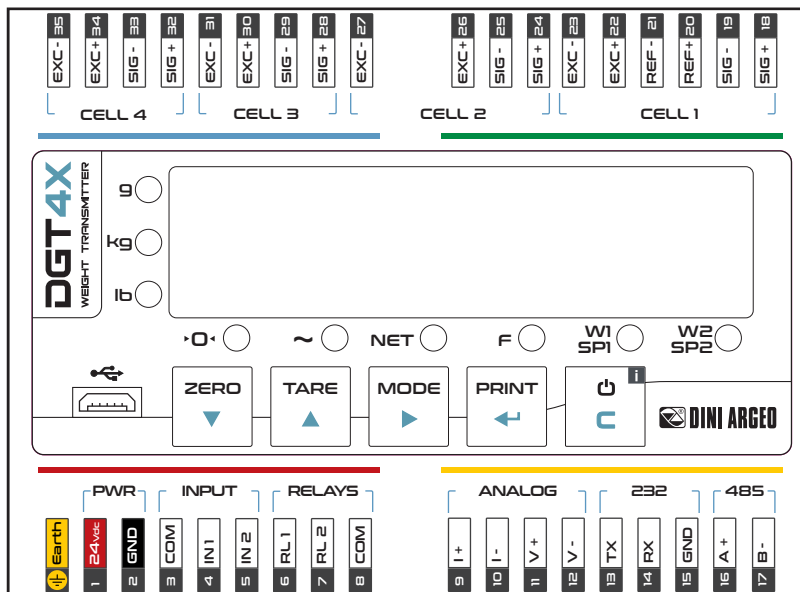

Configuration menu	
▼	Decreases digit / Scroll down.
▲	Increases digit / Scroll up.
▶	Enter the setup. Selects digit to modify.
←	Enters a step / Confirms.
C	Clears / Exits a step (no save).

Weighing mode	
▼	Clears the displayed gross weight.
▲	With short pressing: executes semiautomatic tare. With long pressing: allows to enter known tare.
▶	With long pressing: allows to switch between scales (only in Mode 2 "ind. [h]").
←	With short pressing: execute a data transmission on the printer serial port. With long pressing: Setpoint configuration.
C	ON/Standby of the instrument.

3. Indicator lights meaning

•O•	Weight on zero.
~	Unstable weight.
NET	A tare is active.
F	A function is active.
W SPI	Digital output 1 is active.
W2 SP2	Digital output 2 is active.

4. Configuration menu

1. Reboot the weight transmitter
2. Press the ► key when display shows the 888888 message:

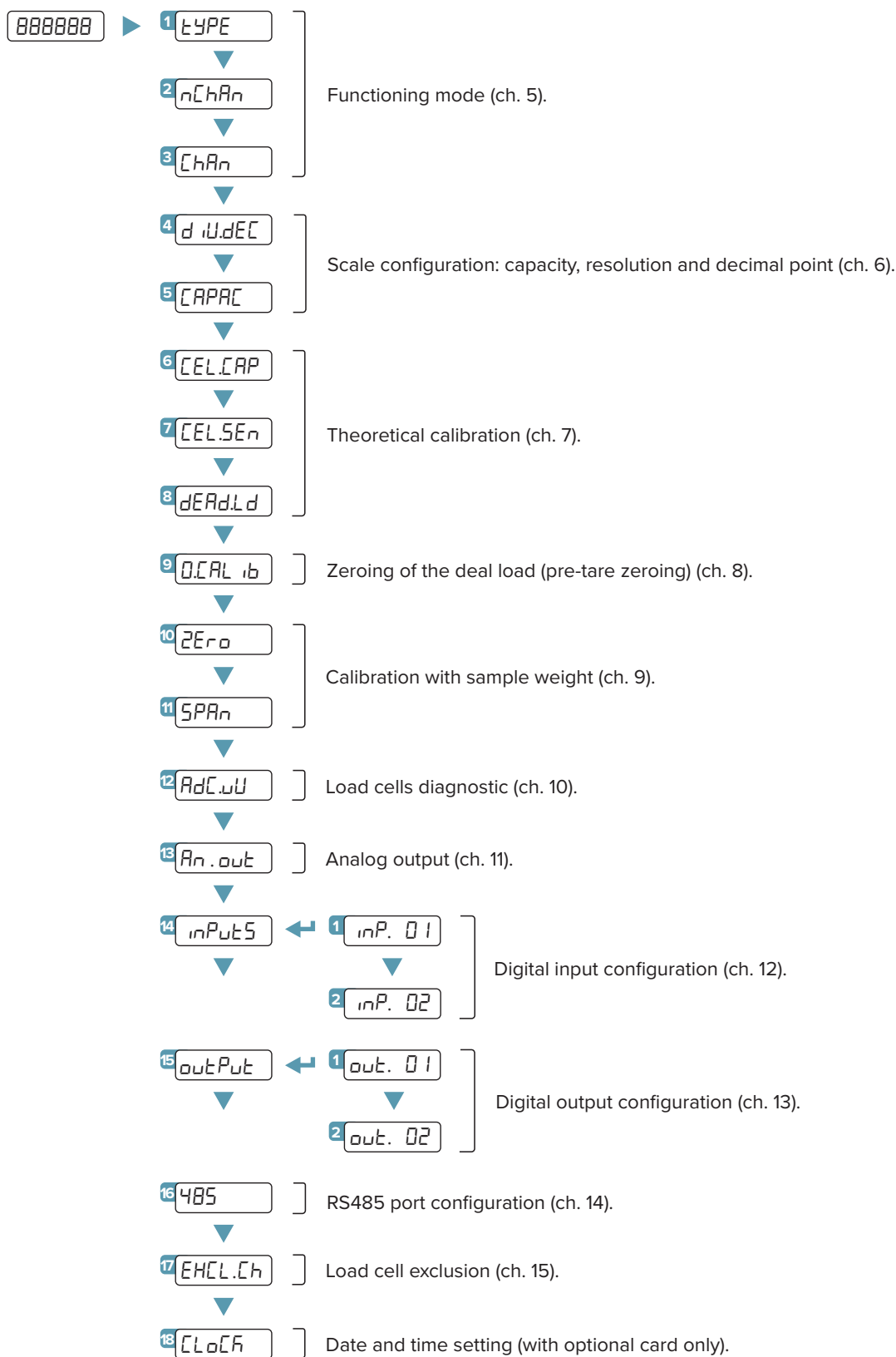

HOW TO EXIT THE MENU AND STORE YOUR CONFIGURATION

1. Press **C** key many times until **SAVE?** message will appear; press **←** to store or press **C** to exit without storing.

6. Maximum scale capacity, increment and decimal point setting

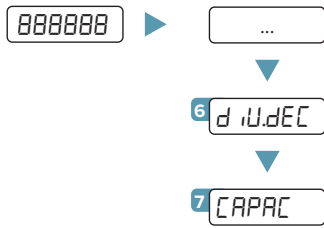

Set the decimal point position and the minimum scale increment*¹
 (0.001 - 0.002 - 0.005 - 0.01 - 0.02 - 0.05 - 0.1 - 0.2 - 0.5 - 1 - 2 - 5 - 10 - 20 - 50).

Set the maximum scale capacity*² (max 999999).

Examples:

For a 60000 kg scale, with 2 kg increment:
 $d.u.dEC = 2$
 $CAPAC = 60000$

For a 10000 g scale, with 0,1 g increment:
 $d.u.dEC = 0.1$
 $CAPAC = 10000.0$

For a 3000 kg scale, with 0,05 kg increment:
 $d.u.dEC = 0.05$
 $CAPAC = 3000.00$

*¹ Increment = the amount that the scale will increment by as weight is added or removed.

*² Maximum capacity = the maximum weight that can be measured using the scale you are creating.

7. Theoretical calibration

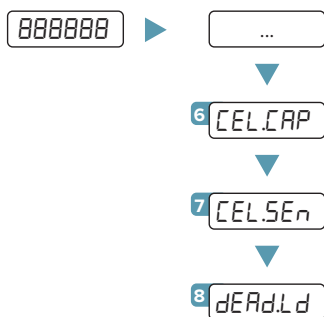

Set the total load cells capacity (up to 999999).

Set the load cells sensitivity (up to 999999). *

Dead load weight (from -9999.9 to 99999.9).

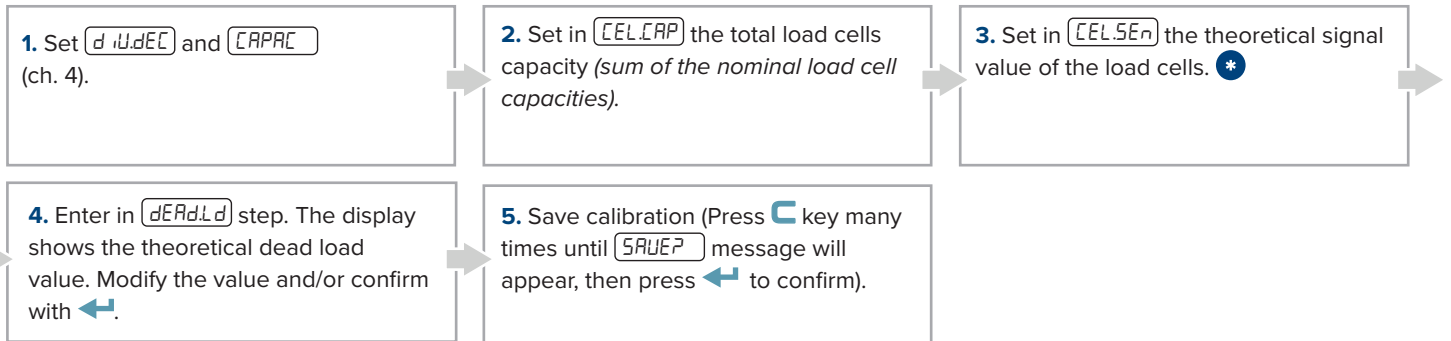

* **MODE 1 "DEP.CH"**

Insert in $CEL.SEn$ parameter, the load cells sensitivity sum value:

$$(mV/V \text{ cell1}) + (mV/V \text{ cell2}) + (mV/V \text{ cell3}) + (mV/V \text{ cell4})$$

MODE 2 "IND.CH"

For each scale to calibrate, insert in $CEL.SEn$ parameter the average sensitivity value of the load cells:

$$\frac{(mV/V \text{ cell1}) + (mV/V \text{ cell2}) + \dots + (mV/V \text{ celln})}{n}$$

8. Zeroing of the mechanic tare (pre-tare zeroing)

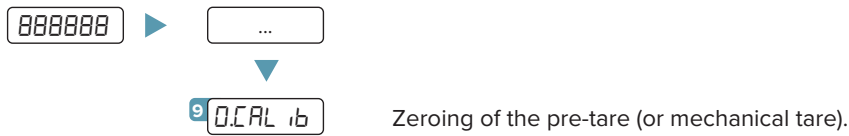

This functionality allows to zero the weigh of the scale structure (e.g. empty silo, conveyor, etc.) without changing the calibration in memory.

9. Calibration with sample weight

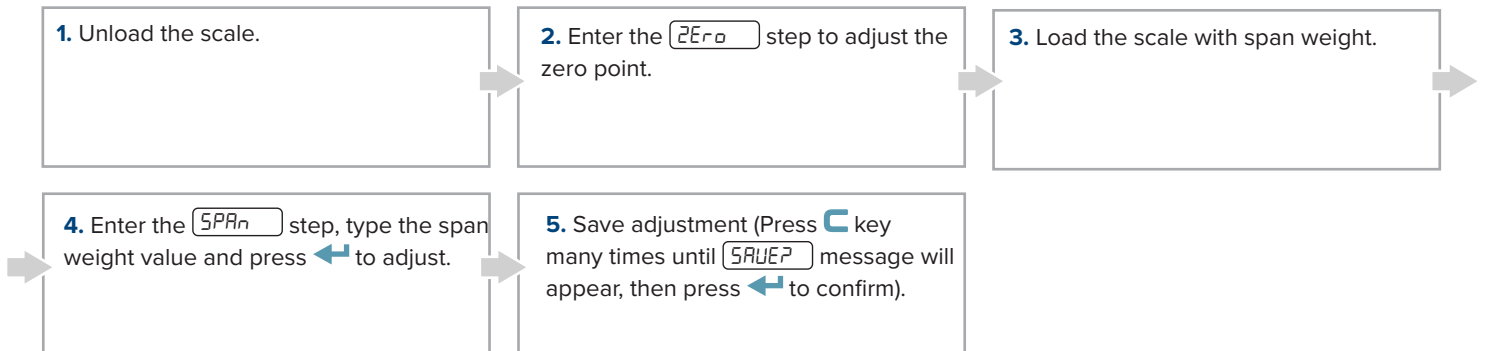
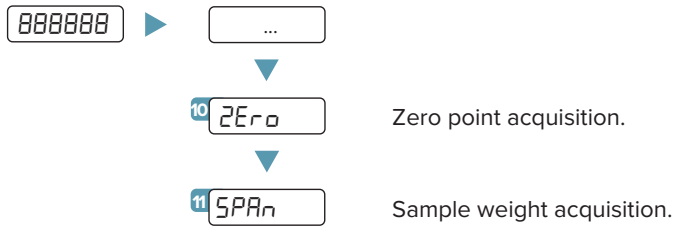

10. Diagnostic of the load cell $\mu V/V$

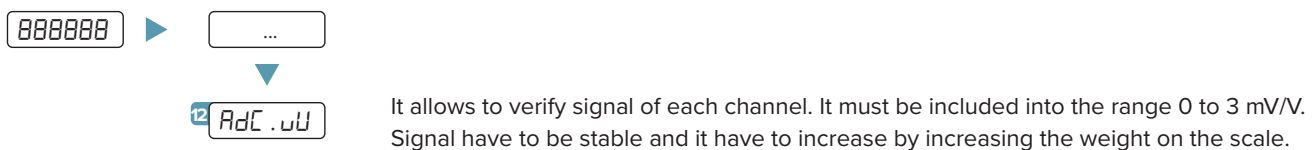

With more channels connected, it's possible to scroll between channels with keys ▼ and ▲.

11.2 EXAMPLES

Impostazione dell'uscita analogica sul peso lordo a 0 10 V, for a 1000 kg scale:

- Connect a multimeter to pins 11 (+) e 12 (-).
- Select 0-10 V in the parameter `ADTYPE`.
- Select `ADCR` in the parameter `MODE`.
- Select the channel (if necessary) in the parameter `CHAN`.
- Set the weight at 0 V in the parameter `WGT.W` (default = 0 kg).
- Set the weight at 10 V in the parameter `WGT.WRH` (default = 1000 kg).
- Correct, if necessary, the output values as shown in chapter 11.2.

Impostazione dell'uscita analogica sul peso netto a 4 20 mA, for a 20000 kg scale:

- Connect a multimeter to pins 9 (+) e 10 (-).
- Select 4-20 mA in the parameter `ADTYPE`.
- Select `ADNET` in the parameter `MODE`.
- Select the channel (if necessary) in the parameter `CHAN`.
- Set the weight at 4 mA in the parameter `WGT.W` (default = 0 kg).
- Set the weight at 20 mA in the parameter `WGT.WRH` (default = 20000 kg).
- Correct, if necessary, the output values as shown in chapter 11.2.

12. Input setting

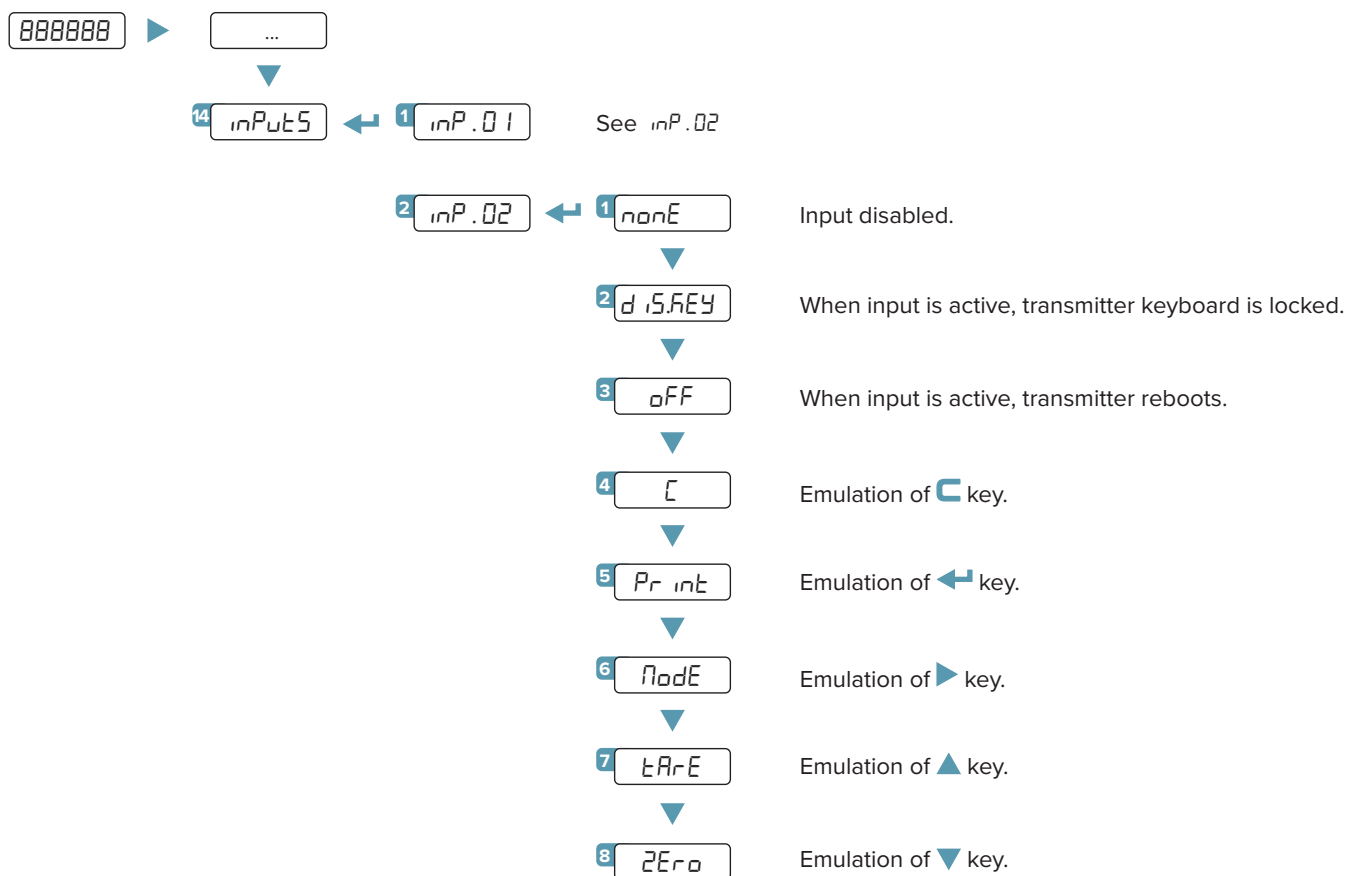

13. Output setting

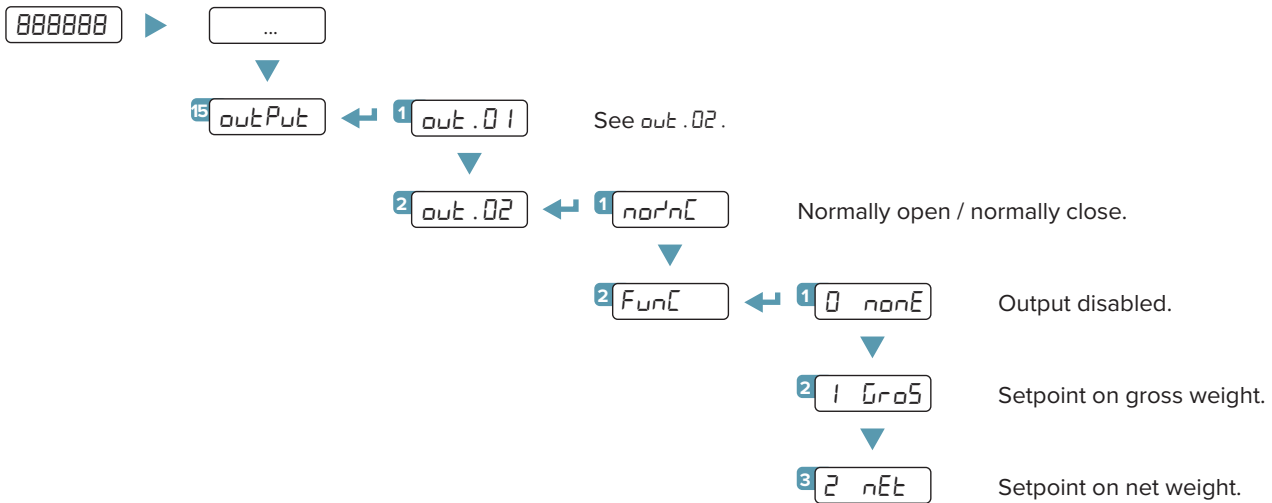

13.1 HOW TO PROGRAM SETPOINTS

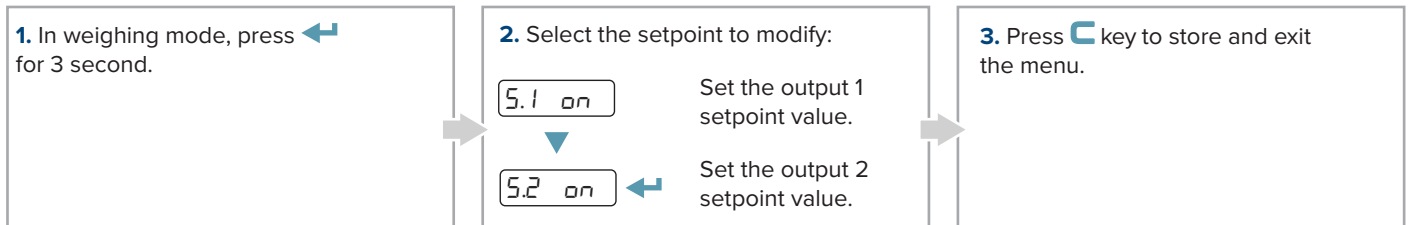

Please refer to the complete technical manual for more information.

14. RS485 port

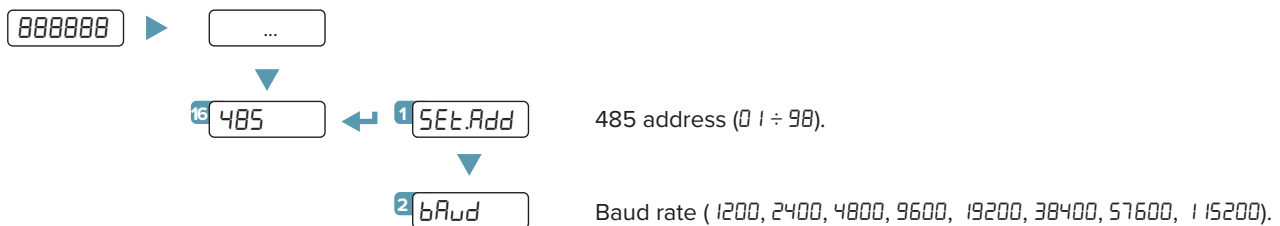

The RS485 port is configured by default to communicate in Modbus RTU (ch. 18).

15. Broken load cell exclusion (for dependent channel systems)

If a load cell is broken, it's possible to temporarily exclude the channel where it is connected and continue to weigh, pending replacement.

WARNING: this operation reduces the accuracy of the weighing system. We recommend use for liquid weighing or in applications where the load is evenly distributed.

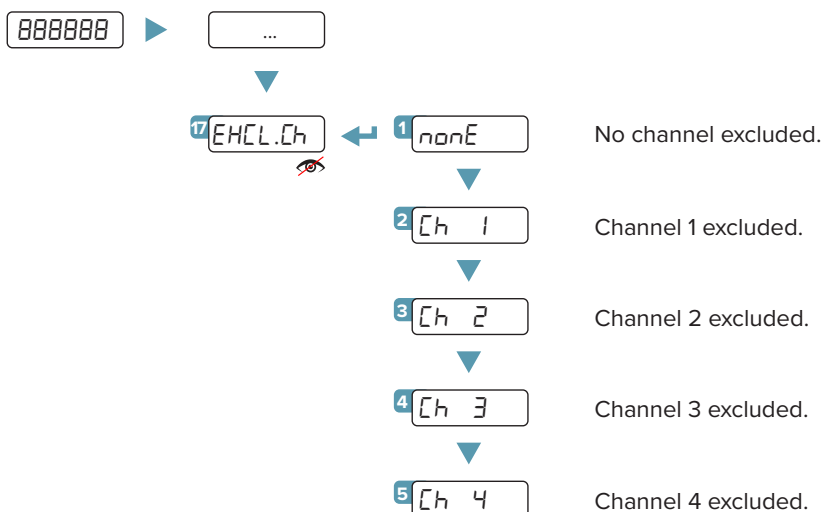

Visible only in dEP.Ch mode.

16. Programming errors

MESSAGE	DESCRIPTION	SOLUTION
PrEC.	Calibration error	First calibrate the zero point (ZErO), then proceed with the sample weight acquisition (SPRn) (ch. 9).
Err.Pnt	Calibration error	Check the connection of the load cell. Check that the cell signal is stable, valid and greater than that of the previously acquired point.
Er 11	Calibration error	Increase the calibration weight.
Er 12	Calibration error	Check that the signal coming from the cell increases upon the increasing of the weight loaded on the scale.
Er 37	Calibration error	Repeat the calibration, checking that the capacity and division have been correctly set.
Er 39	Instrument not configured	Transmitter needs to be configured.
CEr. 36	Calibration error	Check that the signal coming from the load cell is not negative.
CEr. 37	Calibration error	Check that the signal coming from the load cell is not negative.
Err.Pnt	Weight unstable	Check in AdC.uU parameter that the signal is stable. If the connection of the cells is with 4 wires, check that the sense jumpers are inserted.
AdC.Err	A/D converter error	Converter failure. Reboot the instrument.
CEL.Err	Global load cell error	Signal anomaly: check the load cells connection.
Er.CEL.1 ... Er.CEL.4	Load cell error	Signal anomaly: check the indicated load cell connection.

17. Modbus

17.1 MODBUS REGISTERS - dEP.Ch / ind.ch (1 SCALE)

Data	Register	DESCRIPTION													
Gross weight	30001	Gross Weight value.													
	30002														
Net weight	30003	Net Weight value.													
	30004														
Input status register	30005	Bit 15 ^(msb) Active channel. Bit 14 Active channel. Bit 13 No function. Bit 12 No function. Bit 11 No function. Bit 10 No function. Bit 9 Status of input n. 2. Bit 8 _(lsb) Status of input n. 1.													
		<table border="1"> <thead> <tr> <th>Bit 15</th> <th>Bit 14</th> <th>Active Channel</th> </tr> </thead> <tbody> <tr> <td>0</td> <td>0</td> <td>Channel 1</td> </tr> <tr> <td>0</td> <td>1</td> <td>Channel 2</td> </tr> <tr> <td>1</td> <td>0</td> <td>Channel 3</td> </tr> <tr> <td>1</td> <td>1</td> <td>Channel 4</td> </tr> </tbody> </table> Bit 7 ^(msb) 1 = Scale unloaded (gross weight = 0). Bit 6 Tare PT (1 = PT tare is active). Bit 5 Tare (1 = Tare is active). Bit 4 Overload condition (0 = No; 1 = Overload). Bit 3 Underload condition (0 = No; 1 = Underload). Bit 2 Weight Stability (0 = Unstable; 1 = Stable). Bit 1 Gross Weight Polarity (0 = "+"; 1 = "-"). Bit 0 _(lsb) Net Weight Polarity (0 = "+"; 1 = "-").	Bit 15	Bit 14	Active Channel	0	0	Channel 1	0	1	Channel 2	1	0	Channel 3	1
Bit 15	Bit 14	Active Channel													
0	0	Channel 1													
0	1	Channel 2													
1	0	Channel 3													
1	1	Channel 4													
Command status register	30006	Last received command.													
		Bit 7 ^(msb) Last command result. Bit 6 Last command result. Bit 5 Last command result. Bit 4 Last command result. Bit 3 Counting of processed commands. Bit 2 Counting of processed commands. Bit 1 Counting of processed commands. Bit 0 _(lsb) Counting of processed commands.													
Output status register	30007	No Function.													
		Bit 7 ^(msb) No function. ... Bit 2 No function. Bit 1 Digital output 2 status (0 = OFF; 1 = ON). Bit 0 _(lsb) Digital output 1 status (0 = OFF; 1 = ON).													
μ V Channel 1	30111	μ V value of the channel 1.													
μ V Channel 2	30112	μ V value of the channel 2.													
μ V Channel 3	30113	μ V value of the channel 3.													
μ V Channel 4	30114	μ V value of the channel 4.													

This manual contains the main registers for reading data / sending commands. Refer to the Modbus protocol manual for a complete list of available registers.

17.2 MODBUS REGISTERS - *ind.ch* (4 SCALES)

Data	Register	DESCRIPTION
Status register scale 1	40202	Bit 15 _(msb) ... Bit 8 _(lsb) No function.
		Bit 7 _(msb) Bit 6 Bit 5 Bit 4 Bit 3 Bit 2 Bit 1 Bit 0 _(lsb) Tare PT (1 = PT tare is active). Tare (1 = Tare is active). Net Weight Polarity (0 = "+"; 1 = "-"). 1 = Scale unloaded (gross weight = 0). Overload condition (0 = No; 1 = overload). Underload condition (0 = No; 1 = underload). Stability (0 = "unstable"; 1 = "stable"). Gross Weight Polarity (0 = "+"; 1 = "-").
Gross weight scale 1	40203	Gross Weight of scale 1.
	40204	
Status register scale 2	40205	Same as Status register scale 1.
Gross weight scale 2	40206	Gross Weight of scale 2.
	40207	
Status register scale 3	40208	Same as Status register scale 1.
Gross weight scale 3	40209	Gross Weight of scale 3.
	40210	
Status register scale 4	40211	Same as Status register scale 1.
Gross weight scale 4	40212	Gross Weight of scale 4.
	40213	
Net weight scale 1	40214	Net Weight of scale 1.
	40215	
Net weight scale 2	40216	Net Weight of scale 2.
	40217	
Net weight scale 3	40218	Net Weight of scale 3.
	40219	
Net weight scale 4	40220	Net Weight of scale 4.
	40221	

 This manual contains the main registers for reading data / sending commands. Refer to the Modbus protocol manual for a complete list of available registers.

17.3 MODBUS REGISTERS FOR COMMAND SENDING

Data	Register	DESCRIPTION																		
<i>Command</i>	40001	Main available commands:																		
		<table border="1"> <thead> <tr> <th>Value</th> <th>Command</th> </tr> </thead> <tbody> <tr> <td>00 Hex</td> <td>No command</td> </tr> <tr> <td>01 Hex</td> <td>Scale zeroing</td> </tr> <tr> <td>02 Hex</td> <td>Tare</td> </tr> <tr> <td>03 Hex</td> <td>Preset Tare</td> </tr> <tr> <td>0A Hex</td> <td>Setpoint 1 setting</td> </tr> <tr> <td>0B Hex</td> <td>Setpoint 2 setting</td> </tr> <tr> <td>19 Hex</td> <td>Digital output setting</td> </tr> <tr> <td>22 Hex</td> <td>Reboot the weight transmitter</td> </tr> </tbody> </table>	Value	Command	00 Hex	No command	01 Hex	Scale zeroing	02 Hex	Tare	03 Hex	Preset Tare	0A Hex	Setpoint 1 setting	0B Hex	Setpoint 2 setting	19 Hex	Digital output setting	22 Hex	Reboot the weight transmitter
		Value	Command																	
		00 Hex	No command																	
		01 Hex	Scale zeroing																	
		02 Hex	Tare																	
		03 Hex	Preset Tare																	
		0A Hex	Setpoint 1 setting																	
		0B Hex	Setpoint 2 setting																	
19 Hex	Digital output setting																			
22 Hex	Reboot the weight transmitter																			
<i>Parameter 1</i>	40002	First parameter of the command. Parameter is always expressed in absolute mode (no decimals, no sign).																		
	40003																			
<i>Parameter 2</i>	40004	Second parameter of the command. Parameter is always expressed in absolute mode (no decimals, no sign).																		
	40005																			

EXAMPLE 1

For zeroing the weight on the scale:

- Set the command in byte 2

Byte	Value
1	00 Hex
2	01 Hex

EXAMPLE 2

For setting a preset tare of 1000 kg:

- Set the tare value in parameter 1 (byte 3, 4, 5, 6)
- Set the command in byte 2

Byte	Value
1	00 Hex
2	03 Hex
3 _(MSB)	00 Hex
4	00 Hex
5	03 Hex
6 _(LSB)	E8 Hex



This manual contains the main registers for reading data / sending commands.
Refer to the Modbus protocol manual for a complete list of available registers.



A RICE LAKE WEIGHING SYSTEMS COMPANY

HEAD OFFICE

Via Della Fisica, 20
41042 Spezzano di Fiorano, Modena - Italy
Tel. +39 0536 843418 - Fax +39 0536 843521

SERVICE ASSISTANCE

Via Dell'Elettronica, 15
41042 Spezzano di Fiorano, Modena - Italy
Tel. +39 0536 921784 - Fax +39 0536 926654

www.diniargeo.com

Authorized service center stamp

