

PSDS User Manual

mantracourt.com



PSDS

Portable Sensor Display – Strain Bridge

| | |
|---|-----------|
| Introduction / Overview | 3 |
| Key Concepts..... | 3 |
| Calibration Ranges | 3 |
| Advanced Flexible Multi-Point Calibration | 4 |
| Display Modes..... | 4 |
| Decimal Point Position and Resolution..... | 4 |
| TEDS (Transducer Electronic Data Sheet)..... | 5 |
| Basic concept | 5 |
| How it works..... | 5 |
| Advantages | 5 |
| PSD Specifics..... | 6 |
| Supported TEDs Hardware Devices..... | 6 |
| Extended TEDS Calibration Options..... | 6 |
| Overriding TEDS Units | 6 |
| Displayed Error Codes | 7 |
| Configuration Customisation | 8 |
| Measurement Block..... | 9 |
| User Operation..... | 10 |
| Keypad | 10 |
| Display..... | 12 |
| Default Display Modes | 12 |
| Simple Mode | 12 |
| Cumulative Zeroing | 13 |
| Hold..... | 13 |
| Min / Max..... | 13 |
| Delta..... | 14 |
| Go / No Go..... | 14 |
| Icons | 15 |
| Full Screen Messages..... | 16 |
| Menu..... | 17 |
| Menu Basics | 17 |
| Menu Structure | 17 |
| Editing Parameter Values | 21 |
| Editing Numeric Values..... | 22 |
| Editing Text | 23 |
| Connections | 24 |
| Strain Bridge Sensor Field Cable Connector Wiring | 24 |
| Field Cable Preparation (4 Wire Shown) | 25 |
| Connector Assembly | 25 |
| Four (4) Wire & Six (6) Wire Measurement Explained..... | 26 |
| Wiring a Six Wire Strain Bridge Sensor..... | 26 |
| Wiring a Four Wire Strain Bridge Sensor (Existing four wire cable)..... | 26 |
| Wiring a Four Wire Strain Bridge Sensor (On extended six wire cable) | 27 |
| Wiring a Four Wire Strain Bridge Sensor When Four Wire Measurement Configured | 27 |
| Shield Connection..... | 28 |
| Where Strain Bridge Sensor Chassis is Metallic (or surrounding strain bridge sensor structure)..... | 28 |
| Where There is No Option to Connect to Strain Bridge Sensor Chassis..... | 28 |
| Toolkit Configuration..... | 28 |
| Home | 29 |
| Information..... | 30 |
| Settings | 31 |
| Interface Tab | 31 |
| Key Actions Tab..... | 32 |
| Clock Tab | 34 |
| Import / Export | 35 |
| Export Tab | 35 |

| | |
|---|-----------|
| Export Tab – Clone Export | 36 |
| Import Tab | 37 |
| Standard Export File | 37 |
| Clone Export File | 38 |
| Configuration..... | 39 |
| Menus Tab | 39 |
| Calibration Tab | 40 |
| Display Modes Tab | 41 |
| Units Tab..... | 42 |
| Custom Units Tab..... | 43 |
| Firmware Upgrade Tab..... | 44 |
| Displays Tab..... | 45 |
| Summary Sub Tab | 45 |
| Mode 1...6 Sub Tab..... | 46 |
| Select New..... | 47 |
| Management Tab | 48 |
| Logging | 50 |
| Measurement | 53 |
| Calibration | 56 |
| Summary Tab..... | 56 |
| Range 1 – 6 Tabs | 58 |
| Calibration Types | 60 |
| Gain and Offset..... | 60 |
| Multi-Point..... | 61 |
| Polynomial | 62 |
| Management Tab | 63 |
| Alarm..... | 64 |
| Enclosure | 66 |
| Dimensions..... | 66 |
| Battery Compartment..... | 66 |
| USB Connection..... | 66 |
| Accessories | 67 |
| Magnetic Pad..... | 67 |
| Fixed Mount | 68 |
| Carry Case | 69 |
| USB Cable..... | 69 |
| Connector Conversion Cable..... | 69 |
| Specification | 70 |
| Strain Gauge Measurement..... | 70 |
| Electrical, Mechanical & Environmental..... | 70 |
| Units of Measure | 71 |
| EU Declaration of Conformity | 77 |
| UK Declaration of Conformity | 78 |
| Warranty | 79 |

Introduction / Overview

The PSD (Portable Sensor Display) product group is a range of hand-held instrumentation which will cover different sensor types in the future.

The PSDS (Portable Sensor Display Standard) for strain bridge sensors is a microprocessor based portable display instrument designed to interface with any full bridge sensor with an output sensitivity of up to 480mV/V. Bridge resistances from 85 ohms upwards can be used with the PSD.

This module can be either used as a handheld device or, using the optional mounting accessories, or attached to equipment, dashboards, walls, or desks.

Configuration and calibration of the PSD is achieved using the free PC Toolkit software and also limited configuration and two-point calibration via the front panel keypad menu system.

User functions available on the PSD include:-

- Range Selection
- Display Hold/Freeze
- Gross/Net indication selection
- Peak Hold selection
- Trough Hold selection
- TEDS support

The PSD is powered by two internal non-rechargeable AA alkaline batteries and can also be USB powered.

Key Concepts

Calibration Ranges

There are six calibration ranges available that can be individually calibrated for use with strain bridges that do not have TEDS capability.

These ranges can be used for connecting to different strain bridges or for different sections of the same strain bridge ie. one for compression and one for tension. The ranges are user selectable and independent of what is physically connected to the handheld.

The number of ranges available and the ability to switch between these ranges can all be controlled when configuring the handheld.

Each of these ranges will remember settings that contribute to the user experience so for settings such as selected units and tare values etc these will be remembered and reused as each range is selected again.

In addition, there is also support for TEDS calibration tables in TEDS capable connected devices where the calibration information is held in the connected sensor. The user experience settings will be remembered for the last twenty connected TEDS sensors. There is an option to disable TEDS support on a particular TEDS enabled sensor so the handheld calibration ranges can then be used instead.

Advanced Flexible Multi-Point Calibration

The advanced calibration system for the six calibration ranges supports a very flexible calibrate-return-calibrate model where a calibration range can be revisited at any time and individual points can be added or deleted. There is also no restriction on the order that calibration points can be added in terms of input value. Points can be added in ascending, descending or random order of input magnitude.

A simple alternative to multi-point calibration is gain & offset, where the gain and offset values are supplied by the user;

$$\text{Calibrated Output} = \text{offset} + \text{gain} \times \text{input}$$

More flexible polynomial calibration is also supported where x is the m/V input and the coefficients a, b, c, d, e, \dots are supplied by the user;

$$\text{Calibrated Output} = a.x0 + b.x1 + c.x2 + d.x3 + e.x4 + \dots$$

Display Modes

Display modes determine what is visible on the LCD display and what actions are available from the set of three soft keys (Keys whose functions are dynamic and will change depending on what mode is being viewed and local conditions).

There are up to six available display modes that can be cycled through and can be selected from a library of different scenarios when using the Toolkit to configure the handheld.

These display modes are independent to whatever Calibration Range is currently selected.

Decimal Point Position and Resolution

Because the PSDS can handle so many engineering units out of the box and allow conversion between suitable units the way it handles decimal point positions and resolution (For displays) needed a complete overhaul compared to the original PSD.

On the original having only two calibration ranges (And no concept of engineering unit conversion), each range had its own formatting settings for decimal points and resolution and these ranges were very often used to deliver results from the same strain bridge sensor in two different engineering units.

The new PSD has six calibration ranges available where each can automatically convert between the calibrated units and any other unit the user wants to display the values in. Therefore, because each calibration range can display a whole range of engineering units (Although this can be limited by the user it still has that capability) setting the decimal position and resolution per range does not work anymore. I.e. changing from grams to tonnes would be nonsensical if they both shared the setting for 1 decimal place for example. This is even worse for resolution settings when switching between kg and lbs as the display would no longer count in increments suitable for **both** units.

So the new PSD now supports settings for both decimal point position on a per unit basis and resolution on a per calibration range basis.

Out of the box the decimal point position for all units has a sensible default but these can easily be changed using the keypad (until the user chooses to disable that feature) by long presses on the left and right keys. When you are viewing a particular unit simply adjust with the keys and this setting will be remembered any time that unit is selected in any calibration range or a TEDs device is connected showing that unit. Decimal places can be set from zero to seven.

The resolution is disabled by default and is unwieldy to allow changing via the keypad or menu system, but this is fully adjustable using the Toolkit.

Resolution is stored against each Calibration Range (Or in the case of a TEDS device, per device) and is set in the base calibrated units for that range.

For the chosen display units resolution snaps to the nearest appropriate 1,2 or 5 multiple in that unit.

i.e.(.0001, .001, .01, .1, 1, 10, 100, .0002, .002, .02, .2, 2, 20, 200, .0005, .005, .05, .5, 5, 50, 500.)

This selection works across all display modes.

TEDS (Transducer Electronic Data Sheet)

"Plug and play sensor hardware and software make configuring a smart TEDS sensor as easy as plugging a mouse into a PC. The technology has greatly improved efficiency and productivity by completely eliminating manual sensor configuration."

Basic concept

TEDS is at the heart of the universally accepted IEEE 1451.4 standard for delivering Plug and Play capabilities to analogue measurement and test instruments. In essence, information in a Transducer Electronic Data Sheet provides interfacing devices with the critical sensor calibration information in order to perform accurate and precise measurements every time.

TEDS works in a similar way in which USB computer peripherals immediately work as they are connected. TEDS enabled equipment maybe swapped and changed without recalibration, saving time and money.

TEDS holds information such as a sensor manufacturer, model and serial numbers, and more importantly all the calibration settings determined by the manufacturer.

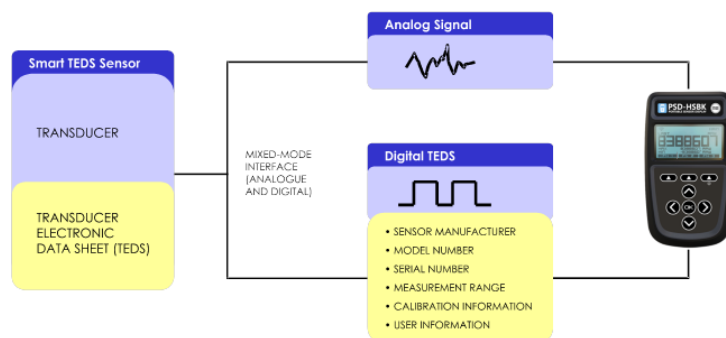

How it works

Plug and play is a data acquisition technology that can simplify the configuration of automated measuring systems by making a sensor's unique identification data available electronically. As implemented according to IEEE 1451.4, data in the form of a transducer electronic data sheet (TEDS) is burned on an electrically erasable programmable read-only memory (EEPROM) chip located on the sensor, so when a properly adapted signal conditioner interrogates the sensor, it can interpret the self-identification data. This technology provides a great benefit by eliminating the need for paper calibration sheets. And because all sensors produced according to the standard will carry the same basic identically formatted self-identification information, you will be able to mix and match sensors and applicable signal conditioners across manufacturers.

Advantages

Plug and play sensors are revolutionizing measurement and automation. With Transducer Electronic Data Sheets (TEDS), your data acquisition system can detect and automatically configure sensors. This technology provides:

- Reduced configuration time by eliminating manual data entry
- Better sensor tracking by storing data sheets electronically
- Improved accuracy by providing detailed calibration information
- Simplified asset management by eliminating paper data sheets
- Reliable sensor location by identifying individual sensors electronically

PSD Specifics

All standard TEDS devices contain a basic 2-point calibration. TEDS devices can also optionally hold more than one extended calibration table; template ID=40 (multi-point calibration) or template ID=41 (polynomial calibration). When you first connect a new TEDS device to the PSD a message will be displayed stating that a new TEDS device has been detected and that default settings have been used.

The first detected, valid calibration table from the TEDS device will be selected.

The user can select an alternative calibration table from the menu or Toolkit and this selection will be remembered and the table will be re-selected next time the device is plugged in.

The PSD will remember the last twenty connected TEDS devices so will automatically select the most recently used calibration table and will re-use the User Experience parameters such as Units and tare values.

There is also an option to ignore TEDS on specific devices so that the PSD Calibration Ranges can be used instead of any Calibration Tables held in the connected TEDS device.

In this case the User Experience parameters will be used from the selected Calibration Range. i.e. The device will act as if there is no TEDS chip until the user re-enables TEDS for this device. When a TEDS disabled device is connected again it will automatically switch to the last used PSD Calibration Range.

Supported TEDs Hardware Devices

DS2431+ and compatible devices

DS2433+ and compatible devices

DS28EC20 and compatible devices



A 4 Kbit (or larger) device is recommended where additional TEDS calibration templates are to be included.

Extended TEDS Calibration Options

The PSD supports up to five extended TEDS calibration tables in addition to the standard 2-point calibration. These can be any combination of template ID=40 (multi-point calibration) or template ID=41 (polynomial calibration). This could be used to provide multiple calibrations for the transducer, for example high range, low range, tension & compression.

Typically, a TEDS-enabled transducer would be supplied with one additional calibration template. The default behaviour is to select the first calibration template, or the standard 2-point if a calibration template is not found. The user can cycle between all the available calibrations unless this feature has been restricted.

The TEDS standard allows very large or complex calibration templates to be defined. For practical reasons the PSD imposes restrictions on the size and complexity that is allowed.

Multi-Point Calibration (template ID=40)

- Maximum calibration points = 10

Polynomial Calibration (template ID=41)

- Maximum number of segments = 1
- Maximum number of coefficients = 10 (10th order polynomial)

Overriding TEDS Units

Sometimes the units held in the TEDS configuration may be incorrect or you simply want to use a different or custom unit. The device menu offers a method to use the custom units mechanism instead of the units held in the TEDS device. See [Menu Structure](#).

Displayed Error Codes

If errors occur whilst connected to a TEDS device an error code will be displayed on the LCD screen.

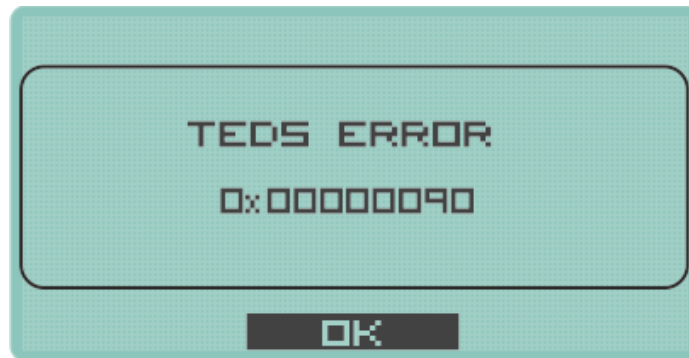

| Bit | Error Description |
|-----|--|
| 0 | 1-wire EEPROM not supported |
| 1 | Read from 1-wire EEPROM failed |
| 2 | Write to 1-wire EEPROM failed |
| 3 | TEDS profile is too large to be written into the 1-wire EEPROM |
| 4 | TEDS decoding failed on a read |
| 5 | CRC in TEDS read failed |
| 6 | Read from TEDS failed |
| 7 | Error reading from standard TEDS template |
| 8 | Error reading from calibration TEDS template |
| 9 | TEDS contains too many calibration templates (>5) |
| 10 | Template 40 contains too many calibration points (>10) |
| 11 | Template 41 contains too many polynomial coefficients (>10) |
| 12 | Template 41 contains too many segments (>1) |
| 13 | Template 42 contains too many entries (>10) |

Configuration Customisation

Many actions and features of the PSD can be hidden or disabled. If certain features mentioned in this manual are not visible on your particular PSD then these features have most likely been locked / protected by your supplier.

The flexible configuration customization offered by the handheld in conjunction with the toolkit offers a unique and powerful way to tailor the device to individual requirements.

- User calibration can be locked down in its entirety and be inaccessible without the password or, using Configuration, only specific calibration ranges may be made available for re-calibration using the toolkit.
- The availability of calibration ranges, display modes, menu items and other features can be configured to simply limit the available options to a purely handheld user. The Configuration is left open so that the handheld can be freely configured again using the toolkit whenever required by anyone.
- The new 'personality' designed using the configuration settings can also be protected behind a password so that the handheld cannot be reconfigured or recalibrated by anyone with a toolkit unless they know the password. This includes restoring saved settings to a handheld. i.e. the protected configuration is locked permanently and cannot be changed by anyone without the password.
- These options allow you to define how the handheld acts and then lock it down to enable redistribution as a specific device for a specific task knowing that this configuration cannot be tampered with.



Mantracourt takes the security of protected devices very seriously. Nobody will be able to unlock any of your protected calibration or configuration without your original password.

A forgotten password **cannot** be recovered but the protected sections can be unprotected again, but this will involve contacting your supplier as Mantracourt will need to verify that you have the rights to the protected data. There will be a charge for this service.

MAKE SURE YOU RECORD ANY APPLIED PASSWORDS!

See later [Toolkit Configuration – Configuration](#)

Measurement Block

The following diagram shows how values and flags are generated. This entire block is processed at the **Measurement Rate** selected. Some processes (such as the calibration and linearization) are only shown as a single block due to their complexity.

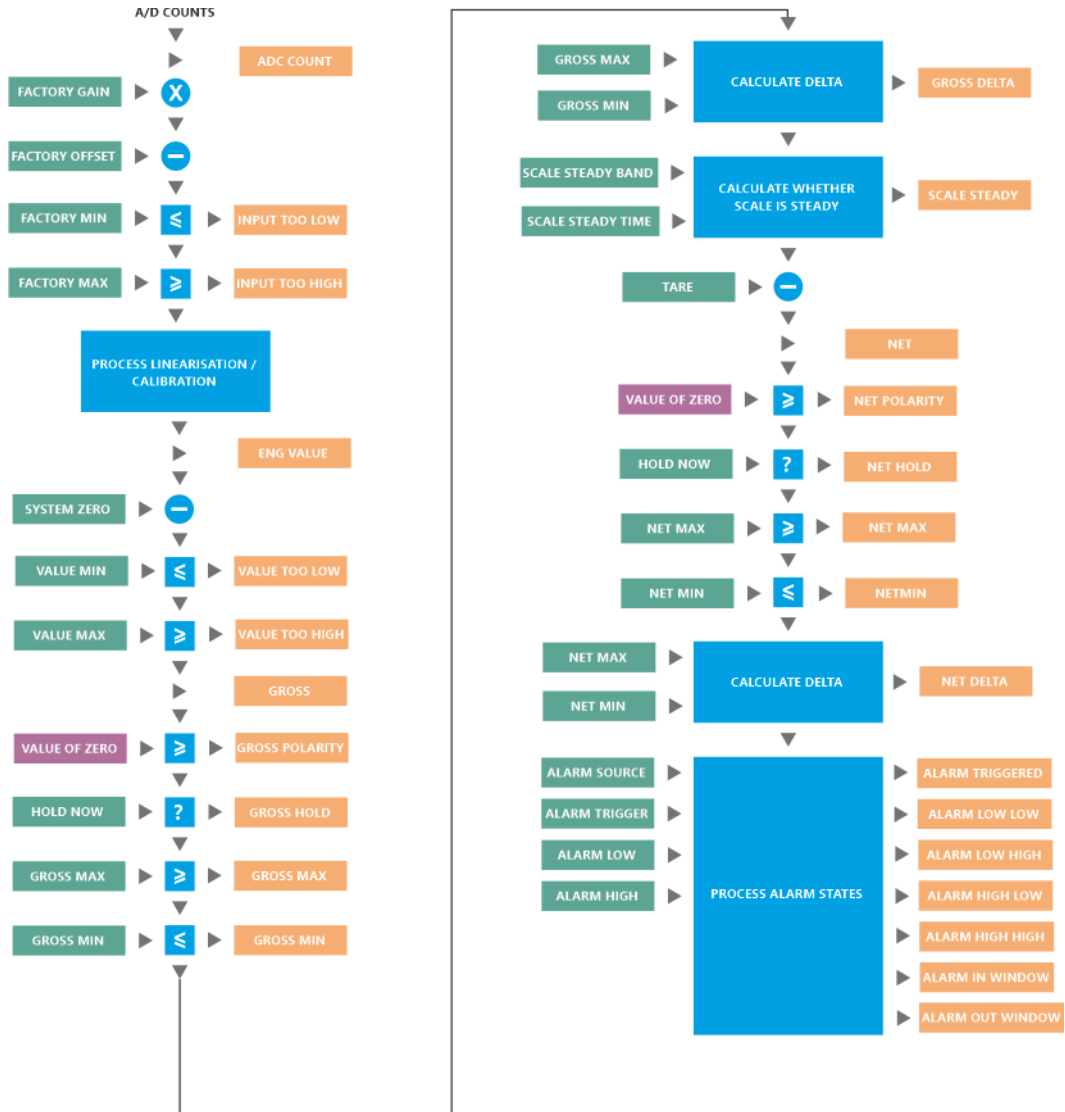

Key:

- Parameter read as part of calculation
- Process block performing calculation
- Fixed value used as part of calculation
- Parameter updated

User Operation

Keypad

The keypad has some functionality that is fixed and some that can be configured and some that changes depending on what is on the LCD display. The handheld can optionally sound a beep when keys are pressed.

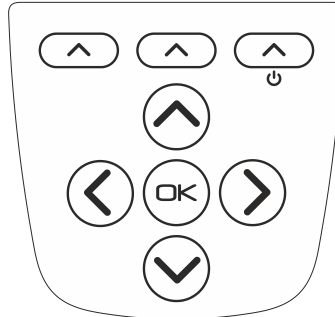

| Key | Function |
|-----|--|
| | The top right key doubles as the power key. Hold this for approximately two seconds to turn on or off the handheld. |
| | The three keys along the top of the keypad are soft keys and relate to the three descriptions shown directly above them on the LCD display. The action of these keys will depend on what is currently being viewed. |
| | <p>The navigation keys are used for various purposes such as selecting the current calibration range, selecting the current display, navigating the menu system or editing string and numeric values.</p> <p>The OK key is used to open the menu (If that has been allowed in the configuration) and to select menu items and complete editing sessions.</p> <p>Later we will explain how to use the keys to navigate the menu system.</p> |
| | <p>When not in a menu the Up/Down keys can perform one of a few user definable functions but the default is to cycle through all available calibration ranges.</p> <p>If a TEDS device is attached then these keys will cycle through any valid Calibration Tables held in the device. If There is no TEDS device (or manual override for that particular TEDS device has been set) then the keys will cycle through the internal device Calibration Ranges.</p> <p>In both the menu and the toolkit the user may also select an action for a long press. A long press is where the key is held down for over a second before being released.</p> |



When not in a menu the **Left/Right** keys can perform one of a few user definable functions but the default is to cycle through all available display modes.

In both the menu and the toolkit the user may also select an action for a long press. A long press is where the key is held down for over a second before being released.



The **OK** key is used to open the menu (If that has been allowed in the configuration) and to select menu items and complete editing sessions.

The **OK** key can also be held down for a long press (Approx one second then released) to cancel any current editing of values and data.

Display

The PSD has a monochrome dot matrix backlit display and the display may change depending on the display mode. However, the basic operation and positions of items should remain intuitive.

The example shown below allows up to three values to be displayed where one is a large, primary value with two secondary values.

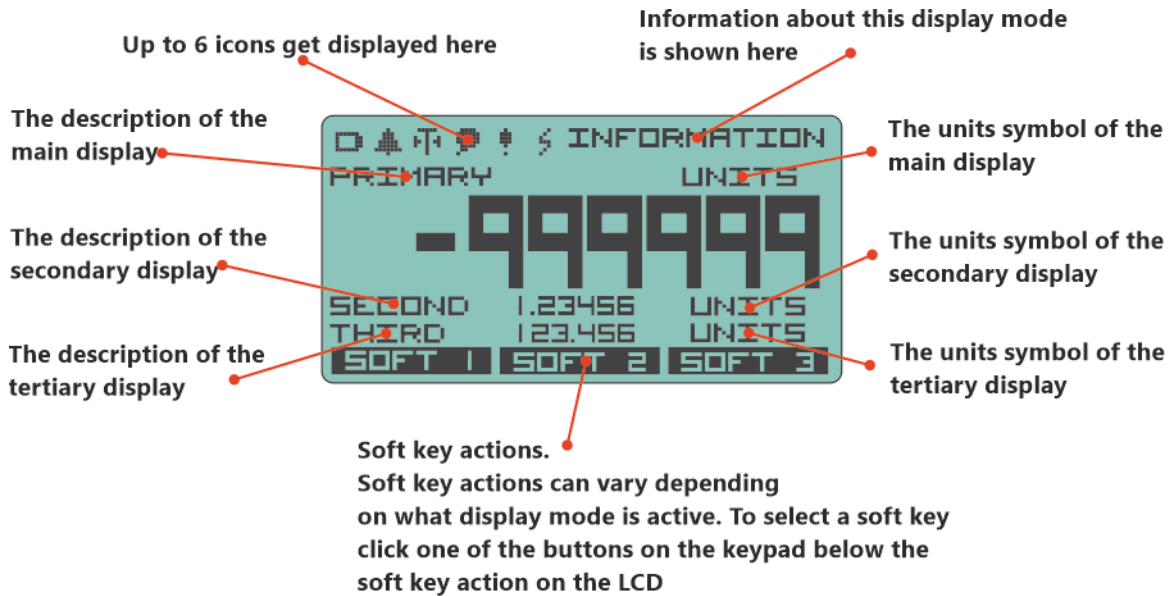

The **values** for the main, secondary and tertiary items are not indicated on the above diagram to improve clarity.

Other modes such as the menu or editing values will be shown in the appropriate sections of the manual.

Default Display Modes

The handheld comes with a set of default Display Modes but the user can swap them for up to six available from a library contained in the Toolkit. The library of Display Modes will grow with new releases of the Toolkit or may be available for download from our web site.

Simple Mode

Used when you only want a simple single displayed value.



The current calibration range is display top right and Gross or Net is displayed above the main value. Current units are displayed above right of the main value.

Soft keys allow you to select from alternative units and to switch between Gross and a zeroed Net value. The state of Gross or Net is displayed above the main value to the left.

Cumulative Zeroing

Similar to simple mode but has the advantage of being continuously able to zero the main display whilst still viewing the Gross value.

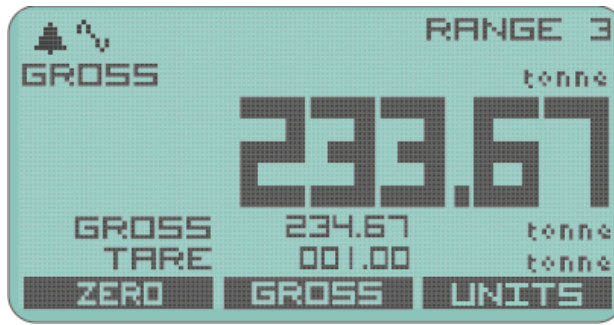

The Gross value and value of Tare are continuously displayed under the main value. Soft keys allow you to Zero the main display, switch back to full Gross value or change displayed units.

Hold

This mode allows you to Hold the main display by using a soft key, whilst still seeing the Live value underneath.

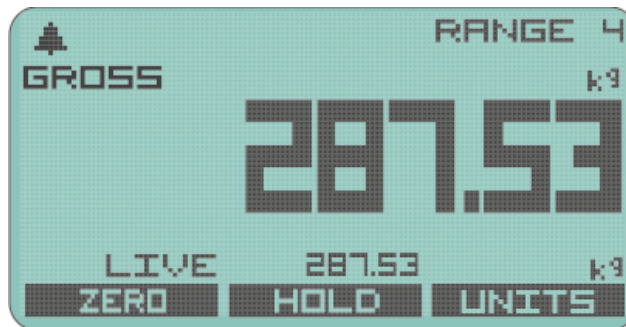

The other soft keys allow being able to Zero the main display or go back to displaying Gross. As usual there is a soft key to allow Units to be selected.

Min / Max

This display shows the min and max values underneath the large normal value display.

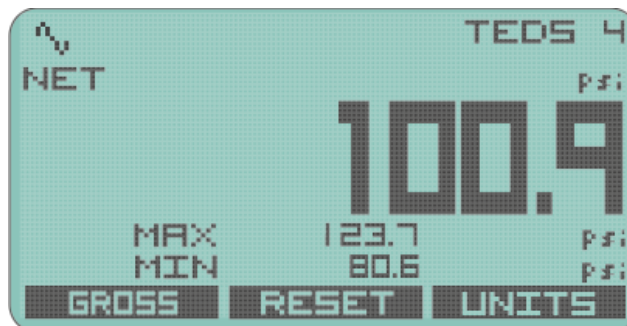

Soft keys allow you to toggle between Zeroed and Gross values and to Reset the min and max to the current value. The usual Units selection is also available.

Delta

Similar to Min / Max above but this allows you to focus on the change in value, or noise.

The display shows the Delta (Difference between Min and Max values) as the main value while the min and max are displayed underneath.



Soft keys allow to Reset the min and max to the current value. i.e. zero the Delta. The usual Units selection is also available.

Go / No Go

This is a very useful display mode for use in conjunction with the Alarm Limits values. The display simply shows PASS when the value is between those limits and FAIL if the value is outside those limits.

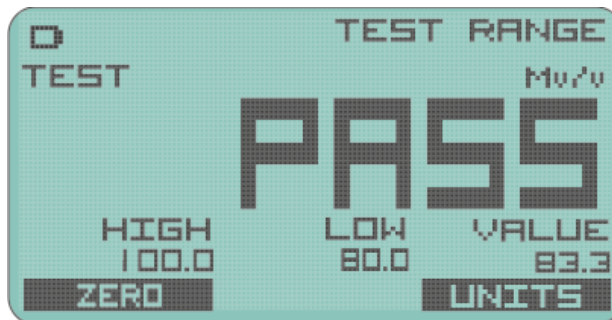

The High limit, Low limit and actual Value are displayed underneath.











Soft keys allow for toggling between Zero and Gross and the Units can be selected.



As there is only one global alarm, that is set in the base units of the currently selected calibration range, you must ensure that the correct calibration range is selected and that the Alarm Latch is not active!

Icons

The set of icons displayed along the top left of the display are common to all display modes and have the following meanings.

- | | | | |
|---|---|---|---|
|  | A warning is detected. Further investigation of the warning may be required either via the keypad or software. Also displayed when alarm is triggered. |  | External USB power has been applied. |
|  | Battery is low. |  | Shunt Calibration mode is in operation. |
|  | The keypad has been locked because some critical processes are being performed by the Toolkit or other software. |  | The Scale Steady functionality is active but the reading is not steady. |
|  | The measurement system is operating in 4-wire mode instead of 6-wire mode. (This feature is only available in certain versions and is not available to change by the user.) |  | A TEDs device is detected as being connected. |
|  | The main display is showing the Net value because a Tare has been executed. |  | The TEDs device is using an internal calibration range rather than its own calibration table. |
|  | The temperature is now too low to operate the LCD at its normal update rate. A slower update rate has been applied. Note that internal measurement (such as peak detection) will not be affected. | | |

Full Screen Messages

Some errors may be so severe that the value displayed cannot be trusted. In these cases a full screen message is displayed which will obscure the value displays to ensure that a potentially invalid value is not acted upon.

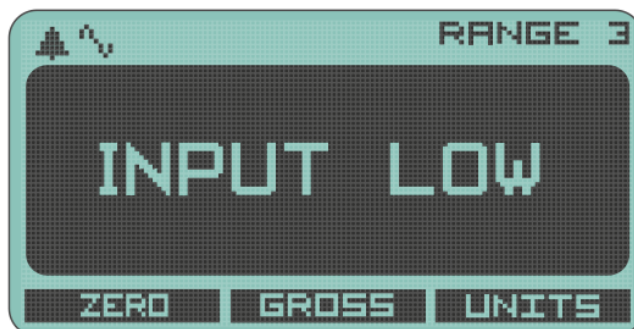

| Message | Reason |
|---|---|
| INPUT HIGH | The mV/V input exceeds the upper limit for the selected sensitivity range of the current calibration range. |
| INPUT LOW | The mV/V input is below the lower limit for the selected sensitivity range of the current calibration range. |
| OVERLOAD | The input value exceeds the user level set as overload. |
| UNDERLOAD | The input value is below the user level set as underload. |
| TEDS DISCONNECTED SESSION RESTORED | A TEDs device has been disconnected so the handheld is reverting to the last selected calibration range. (Click OK) |
| MULTIPLE TEDS ARE NOT SUPPORTED! | More than one TEDs device has been detected and this is not allowed. |
| NEW TEDS DEVICE USE SESSION DEFAULTS | A new TEDs device has been detected so default values will be used for all settings not held in the TEDs device itself. |
| KNOWN TEDS DEVICE SESSION RESTORED | A TEDs device has been reconnected so all the user settings from the previous session will be applied. (Click OK) |
| TEDs ERROR Code 0x0000 | An error has been detected in the connected TEDs device. See displayed error code and refer to the error code table in this manual. |
| BATTERY TOO LOW REPLACE IMMEDIATELY | Battery is too low to start the handheld. |



Note: Because the keypad gets locked during toolkit configuration, avoid swapping TEDS devices while connected to the toolkit as you will not be able to dismiss any full screen messages that may appear.

Menu Basics

The menu is accessed by holding the OK key for around one second. It is possible to lock out the menu system so if your handheld does not display a menu it may be that your supplier has locked this feature. Individual features may also have been hidden by your supplier.



The currently selected menu item is displayed on a dark background and this selection can be changed by using the up and down keys. Pressing OK will select that item and can either:

- Perform an action (Such as increasing LCD contrast)
- Edit a value (Such as editing an alarm level value)
- Display the items sub menu (Indicated by a following > symbol)

The menu system is a standard hierarchal one but does have some visual clues to help you navigate.

- If a menu item leads to a sub menu (Another list of items) it will display a ► to the right.
- If a menu item is part of a list where only one item can be selected at a time then the current active selection is indicated by a leading dot ● to the left. All items that this can apply to are shown as a ● below for clarity.
- Some items will lead to a displayed value or text which may be edited. See the next section regarding Editing Values where this is described. Shown as a following ●●● for clarity.

Menu Structure

MENU

| | |
|-----------------|--|
| | Menu is activated by holding the OK key for 1 second. |
| SYSTEM ► | System Menu contains settings for display and user interface and other system wide settings. |
| DISPLAY | Handles settings to do with the display and backlight. |
| CONTRAST ► | Allows the LCD contrast to be configured. |
| INCREASE | Instantly increases LCD contrast. |
| DECREASE | Instantly decreases LCD contrast. |
| BACKLIGHT ► | Allows the backlight settings to be configured. |
| INCREASE | Instantly increases brightness. |
| DECREASE | Instantly decrease brightness. |
| MODE ► | Select this item to choose the backlight operation mode. |
| ● OFF | Backlight is always off. |
| ● ON | Backlight is always on. |
| ● AUTO | Backlight is on but will turn off after a certain duration when no keys are pressed. Any key press will turn the backlight on again. |

| | |
|---|--|
| <ul style="list-style-type: none"> └ DURATION ●●● | <p>If Backlight Mode is set to Auto this sets the duration after which the backlight will turn off.</p> |
| <ul style="list-style-type: none"> └ AUTO-OFF ► | <p>Controls whether the handheld turns itself off after a duration without key presses.</p> |
| <ul style="list-style-type: none"> └ MODE ► <ul style="list-style-type: none"> └ ● DISABLED └ ● ENABLED | <p>Select Auto Off mode of operation.</p> <p>Disable Auto Off.</p> <p>Enable Auto Off.</p> |
| <ul style="list-style-type: none"> └ TIMEOUT●●● | <p>Display and edit the duration before the handheld turns off without a key press when Auto Off is enabled. (Only visible when mode is enabled.)</p> |
| <ul style="list-style-type: none"> └ USER INTERFACE ► | <p>Allows changes to be made to the way the user interface behaves.</p> |
| <ul style="list-style-type: none"> └ KEY ACTIONS ► | <p>Select this item to choose what feedback occurs when a valid key press is detected.</p> |
| <ul style="list-style-type: none"> └ ● NONE └ ● BEEP | <p>No feedback.</p> <p>The sounder will issue a beep.</p> |
| <ul style="list-style-type: none"> └ KEYS UP/DOWN ► | <p>Select this item to choose the action when the up and down keys are pressed (When not in the menu).</p> |
| <ul style="list-style-type: none"> └ ● RANGE SELECTION | <p>Select the next Calibration Range.</p> |
| <ul style="list-style-type: none"> └ ● DISPLAY SELECTION └ ● DECIMAL PLACES | <p>Select the next Display Mode.</p> <p>Increase or decrease the number of decimal places displayed for all displayed values using the same units as the main display.</p> |
| <ul style="list-style-type: none"> └ ● DISABLED | <p>No Action</p> |
| <ul style="list-style-type: none"> └ KEYS LEFT/RIGHT ► | <p>Select this item to choose the action when the left and right keys are pressed (When not in the menu).</p> |
| <ul style="list-style-type: none"> └ ● RANGE SELECTION | <p>Select the next Calibration Range (Only for non TEDS devices).</p> |
| <ul style="list-style-type: none"> └ ● DISPLAY SELECTION └ ● DECIMAL PLACES | <p>Select the next Display Mode.</p> <p>Increase or decrease the number of decimal places displayed for all displayed values using the same units as the main display.</p> |
| <ul style="list-style-type: none"> └ ● DISABLED | <p>No Action</p> |
| <ul style="list-style-type: none"> └ LONG UP/DOWN ► | <p>Select this item to choose the action when the up and down keys are pressed and released after around one second (When not in the menu).</p> |
| <ul style="list-style-type: none"> └ ● RANGE SELECTION | <p>Select the next Calibration Range (Only for non TEDS devices).</p> |
| <ul style="list-style-type: none"> └ ● DISPLAY SELECTION └ ● DECIMAL PLACES | <p>Select the next Display Mode.</p> <p>Increase or decrease the number of decimal places displayed for all displayed values using the same units as the main display.</p> |
| <ul style="list-style-type: none"> └ ● DISABLED | <p>No Action</p> |
| <ul style="list-style-type: none"> └ LONG LEFT/RIGHT ► | <p>Select this item to choose the action when the left and right keys are pressed and released after around one second (When not in the menu).</p> |
| <ul style="list-style-type: none"> └ ● NONE └ ● RANGE SELECTION | <p>No action.</p> <p>Select the next Calibration Range (Only for non TEDS devices).</p> |
| <ul style="list-style-type: none"> └ ● DISPLAY SELECTION └ ● DECIMAL PLACES | <p>Select the next Display Mode.</p> <p>Increase or decrease the number of decimal places displayed for all displayed values using the same units as the main display.</p> |

| | |
|----------------------|--|
| TIME & DATE ► | Allows setting of time and date. |
| TIME NOW ●●● | Display time and date. |
| SET DATE ●●● | Display and edit the date. |
| SET TIME ●●● | Display and edit the time. |
| DATE FORMAT ► | Choose the format for displayed dates. |
| ● YYYY/MM/DD FORMAT | |
| ● DD/MM/YYYY FORMAT | |
| ● MM/DD/YYYY FORMAT | |
| ABOUT ► | Displays information about this product. |
| ALARM ► | Configure settings for the global alarm. |
| ** ALARM CANCEL ** | Only appears when a latched alarm state is present. Click to retry alarm state. |
| ALARM SOURCE ► | Select the source value the alarm is based on. |
| ● GROSS | Base Alarm on Gross value. |
| ● NET | Base Alarm on Net value. |
| ALARM MODE ► | Select the alarm mode. |
| ● NORMAL | Alarm only active while value matches trigger criteria. |
| ● LATCHED | Alarm remains active until reset once triggered. |
| ALARM THRESHOLDS ► | Set the alarm low and high thresholds. |
| ● ALARM LOW ●●● | Edit Low Alarm value. |
| ● ALARM HIGH ●●● | Edit High Alarm value. |
| ALARM TRIGGER ► | Select how the alarm is triggered. |
| ● DISABLED | The Alarm is disabled. |
| ● OUTSIDE LIMITS | Alarm is triggered when the source value is below the Alarm Low level or above the Alarm High Level. |
| ● INSIDE LIMITS | Alarm is triggered when the source value is higher than the Alarm Low level and lower than the Alarm High Level. |
| ● ABOVE HIGH | Alarm is triggered when the source value is above the Alarm High level. |
| ● BELOW HIGH | Alarm is triggered when the source value is below the Alarm High level. |
| ● ABOVE LOW | Alarm is triggered when the source value is above the Alarm Low level. |
| ● BELOW LOW | Alarm is triggered when the source value is below the Alarm Low level. |
| ALARM ACTION ► | Select one of these actions to occur when the Alarm is triggered. |
| ● NONE | No action. (Will still trigger warning icon and Pass/Fail Display Mode will still operate) |
| ● BEEP | Play beep sound. |
| ● FLASH | Flash the main display. |
| ● BOTH | Do both. |
| MEASUREMENT ► | Allows configuration of the various measurement settings |
| MEASUREMENT RATE ► | Select the required Measurement Rate at which new values will be generated. The faster the rate the more this affects battery life. (SPS = Samples Per Second) |
| ● 1 SPS | One per second. |
| ● 3 SPS | Three per second. |
| ● 10 SPS | Ten per second. |
| ● 50 SPS | Fifty per second. |

| | |
|--|---|
| <ul style="list-style-type: none"> • 100 SPS • 1200 SPS • 2400 SPS | <p>One hundred per second.</p> <p>One thousand two hundred per second.</p> <p>Two thousand four hundred per second.</p> |
| MEASUREMENT QUALITY ▶ | Select the desired quality. This will affect the noise free resolution and battery life. |
| <ul style="list-style-type: none"> • LOW • HIGH | <p>Lowest quality.</p> <p>High Quality.</p> |
| CURRENT RANGE ▶ | Configure the System Zero options |
| SYSTEM ZERO ▶ | Configure the System Zero options |
| VIEW/EDIT ZERO ●●● | Display and edit the current Zero value |
| ZERO NOW | Perform a System Zero now |
| REMOVE ZERO | Remove any existing System Zero value |
| TARE VALUE ▶ | Configure the Tare options |
| VIEW/EDIT TARE ●●● | Display and edit the current Tare value |
| TARE NOW | Perform a Tare now |
| REMOVE TARE | Remove any existing Tare value |
| SCALE STEADY ▶ | Configure the Scale Steady values |
| BAND ●●● | Display and edit the Scale Steady ± band |
| INTERVAL ●●● | Display and edit the time interval over which the value must be within the band to constitute Scale Steady |
| SET ZERO MASK ●●● | Display and edit the Zero Mask value. This is entered in base calibrated units for this range and when the value is less than this level a zero will be displayed. |
| SET RESOLUTION ●●● | Display and edit the Resolution value in base calibrated units for this range. The display will change in increments of this value. |
| SET MIN LIMIT ●●● | Display and edit the Minimum user level in base units for this range. When the value falls below this a full screen Underrange message will be displayed. |
| SET MAX LIMIT ●●● | Display and edit the Maximum user level in base units for this range. When the value falls below this a full screen Overrange message will be displayed. |
| CALIBRATION ▶ | This menu contains settings regarding Calibration. |
| CALIBRATION INFO ▶ | Shows information about the currently selected calibration range. Information: Name, Mode, Units, Type and last calibration date. |
| USER CALIBRATION ▶ | Only available when no active TEDS device is attached |
| RANGE NAME ▶ | Only available when no active TEDS device is attached |
| RANGE 1 | Select a Calibration Range item to display and edit its text description. |
| RANGE 2 | Some Calibration Ranges may not be available. |
| RANGE 3 | |
| RANGE 4 | |
| RANGE 5 | |
| RANGE 6 | |
| SELECT RANGE ▶ | Only available when no active TEDS device is attached. This allows you to select the current Calibration Range to use. Some ranges may not be available. |
| <ul style="list-style-type: none"> • RANGE 1 • RANGE 2 • RANGE 3 • RANGE 4 • RANGE 5 • RANGE 6 | <p>Select Calibration Range 1.</p> <p>Select Calibration Range 2.</p> <p>Select Calibration Range 3.</p> <p>Select Calibration Range 4.</p> <p>Select Calibration Range 5.</p> <p>Select Calibration Range 1.</p> |
| LIVE CALIBRATION ▶ | Only available when no active TEDS device is attached. |
| SENSITIVITY | Select the desired sensitivity. Select an input range that covers the strain bridge being connected. |
| <ul style="list-style-type: none"> • 7.5 mV/V | Select the desired sensitivity. |

| | |
|---|--|
| <ul style="list-style-type: none"> • 15 mV/V • 30 mV/V • 60 mV/V • 120 mV/V • 240 mV/V • 480 mV/V | |
| UNIT | Select the units that the calibration is to be performed in. |
| <ul style="list-style-type: none"> • kg • kilograms | Select desired units by highlighting either the units symbol line or the units description line and press OK. This will cycle through all available units. (<i>Example Shown for kilograms</i>) |
| LOW/HIGH CALIBRATION | Configure the low and high points to perform calibration. Only a two point calibration can be performed using the keypad. |
| SET OUTPUT LOW | Enter a value in the units (selected above) as the low point of the known two point calibration. |
| SET OUTPUT HIGH | Enter a value in the units (selected above) as the high point of the known two point calibration. |
| CAPTURE mV/V LOW | Capture the inputs for mV/V to represent the two outputs entered above. If you actually apply the known force to the input when selecting these options the detected mV/V will be displayed ready to either select OK or to manually edit. |
| CAPTURE mV/V HIGH | |
| APPLY ●●● | Use all of the information captured above to perform the actual calibration. |
| TEDS ► | Only available if a TEDS device is attached. |
| TABLE NAME ► | Displays and edits the global name to give each TEDS Calibration Table. This applies to all TEDS devices |
| <ul style="list-style-type: none"> • TEDS STD • TEDS CAL1 • TEDS CAL2 • TEDS CAL3 • TEDS CAL4 • TEDS CAL5 | Select a Calibration Table item to display and edit its text description. Some Calibration Tables may not be available. |
| SELECT TEDS TABLE ► | Only available when an active TEDS device is attached. Select which of the Calibration Tables held in the TEDS device to use. |
| <ul style="list-style-type: none"> • TEDS STD • TEDS CAL1 • TEDS CAL2 • TEDS CAL3 • TEDS CAL4 • TEDS CAL5 | Select TEDS Calibration Table 1. Select TEDS Calibration Table 2. Select TEDS Calibration Table 3. Select TEDS Calibration Table 4. Select TEDS Calibration Table 5. Select TEDS Calibration Table 6. |
| TEDS MODE ► | Select whether a TEDS device is enabled / active or disabled / inactive |
| <ul style="list-style-type: none"> • ENABLED (TEDS) • DISABLED (PSD) | Enable TEDS support on the connected device. Disable TEDS support on the connected device. |
| TEDS UNITS ► | Allows you to optionally override the units held in TEDS and instead use the first of the custom units available in the Toolkit . This will also then allow unit conversion to selectable using up to three of the remaining custom units slots. |
| <ul style="list-style-type: none"> • TEDS UNITS • CUSTOM UNITS | Use the units specified in the TEDS device. Use the first custom units item instead of the TEDS units. |

Editing Parameter Values

Some menu items allow you to edit / enter a numeric value or text.





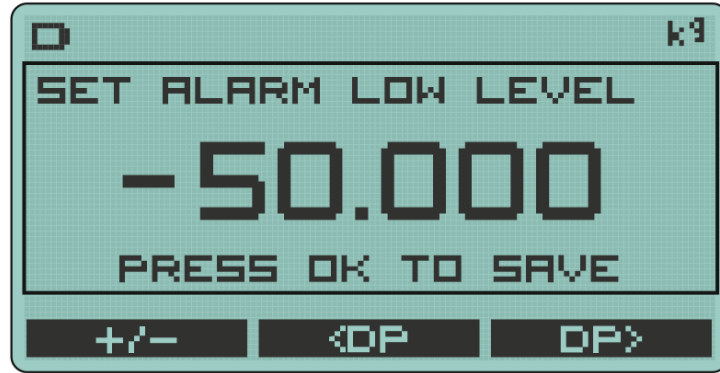



Editing Numeric Values

The following example screen shows what would be displayed for editing the Alarm Low level.



The text at the top right states the engineering units of the value being entered. The text at the top inside the box states what parameter is currently being edited.

One of the digits will be the current selection and this digit will flash alternatively displaying its character and an underlined space.

| Key | Function |
|---|--|
|   | These keys are used to change the currently selected (Flashing digit or character). |
|   | These keys will increment or decrement the currently selected digit. In the case of text the letters of the alphabet will be cycled through. |
| The soft keys at the bottom will (where appropriate) allow you to: | |
|  | Toggle the sign between positive and negative. |
|  | Move the decimal place to the left. |
|  | Move the decimal place to the right. |
|  | Click the OK key to stop editing and save the value. |







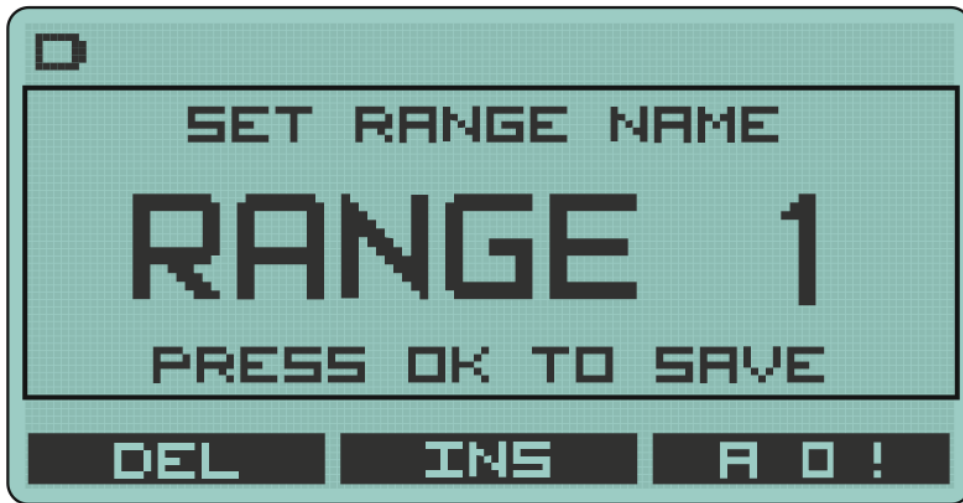

 *Pressing and holding this key for over a second then releasing will cancel the current edit.*

Editing Text

The following example screen shows what would be displayed for editing the name of a calibration range.



The text at the top inside the box states what parameter is currently being edited. One of the characters will be the current selection and this character will flash alternatively displaying its character and an underlined space.

| Key | Function |
|---|--|
|   | These keys are used to change the currently selected (Flashing digit or character). |
|   | These keys will increment or decrement the currently selected digit. In the case of text the letters of the alphabet will be cycled through. |
| The soft keys at the bottom will (where appropriate) allow you to: | |
|  | Delete the current character selection. |
|  | Insert another character to the left of the flashing cursor. |
|  | Cycle between character modes. Alpha, numeric and symbol. |
|  | Click the OK key to stop editing and save the value. |

 *Pressing and holding this key for over a second then releasing will cancel the current edit.*

Connections

Strain Bridge Sensor Field Cable Connector Wiring



To attach this connector to the handheld, align the white arrow on the connector with the white line on the handheld socket then rotate the locking collar as indicated on the connector.

The connector fitted to PSD Standard Product is BINDER 770-8. The cable fitted mating connector is a BINDER 771 8-way male connector. This male connector is available under three different BINDER Order Codes determined by the field cable diameter.

| Field cable diameter (mm) | Binder Order Code | MEL Stock code |
|---------------------------|-------------------|----------------|
| 2.5 to 4.0 | 99 0771 000 08 | Not Stocked |
| 4.0 to 6.0 | 99 0771 001 08 | 427-739 |
| 6.0 to 8.0 | 99 0771 002 08 | 427-741 |

Recommended cable BELDEN 9504 4-pair cable. Max cable size 0.25 mm² , AWG 24.

List of conductor identification and functions.

| Cable pair | Suggested Colour | Connector Pin | Function |
|---------------|------------------|---------------|---|
| 1 | White | 1 | Bridge Sensor Reference +ve |
| | Black | 2 | Bridge Sensor Reference -ve |
| 2 | Green | 3 | Bridge Sensor Signal +ve |
| | Black | 4 | Bridge Sensor Signal -ve |
| 3 | Red | 5 | Bridge Sensor Excitation +ve |
| | Black | 6 | Bridge Sensor Excitation -ve |
| 4 | Blue | 7 | TEDS |
| | Black | 8 | Ground |
| Shield/Screen | Grey | | Cable screen should <i>only</i> be connected to chassis of the sensor. If this cannot be achieved then it should be connected to Excitation -ve. |

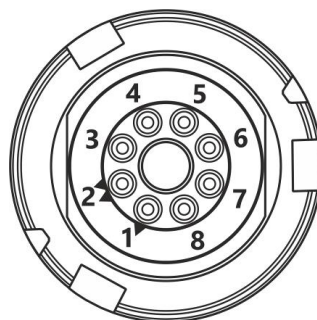

View from solder connector side of the connector

Field Cable Preparation (4 Wire Shown)

Strip 15 to 20mm of outer sheath. Strip 2mm of insulation from each conductor. Conductor diameter of Belden 9504 cable is at the maximum accommodated by connector solder buckets, so check fit before tinning. Note that pin one is identified with a single triangle and pin two by dual triangles.

The diagram below shows the recommended wire lengths to fit inside the plug body. This also shows the recommended method to use when one wire is required to connect to two connector pins:



Connector Assembly

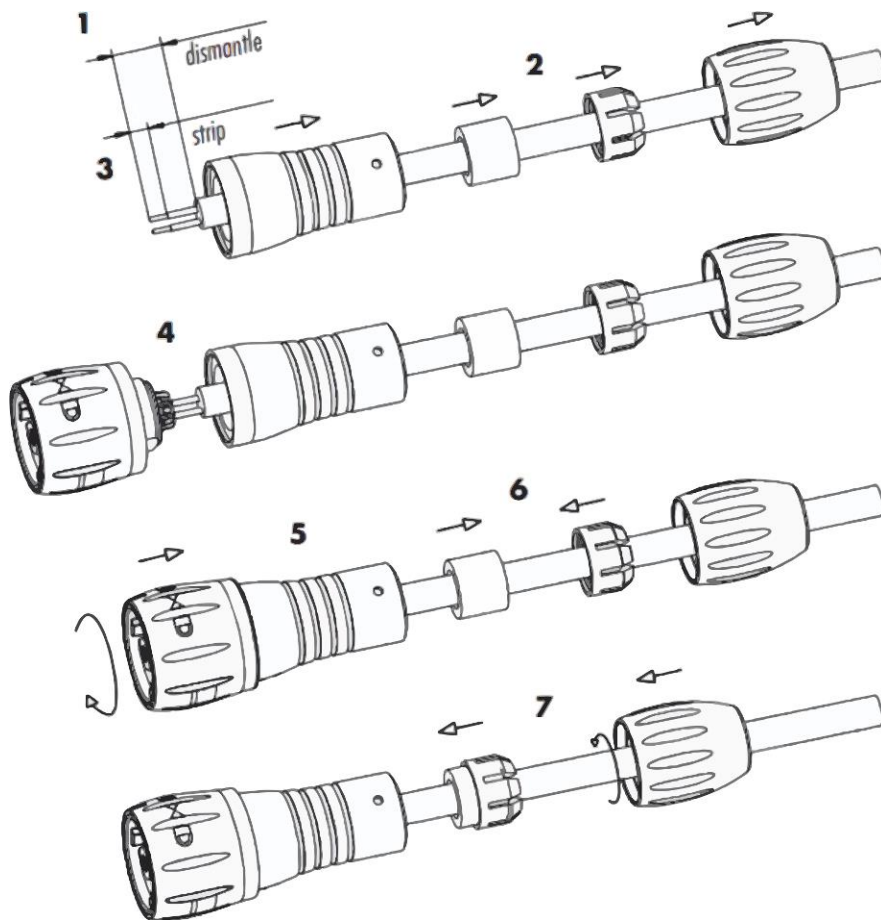

If a cable is already connected to the connector remember to unscrew the cable clamp before unscrewing the main body of the connector otherwise, you risk twisting the cable and breaking the connections.

If the main body is difficult to unscrew it may be easier to lock the connector to the handheld then grip and unscrew the main body in an anti-clockwise direction.

Four (4) Wire & Six (6) Wire Measurement Explained

The PSD utilizes a six wire measurement system, by default, to achieve maximum accuracy when connecting to a strain bridge sensor.

Four wire strain bridge sensor can still be used but please review the recommendations below to get the best out of the measurement system.

A six wire measurement system has one very big advantage over a four wire measurement system in that the length of the cable connecting the handheld to the strain bridge sensor can be compensated for in terms of losses along its length. Meaning that even after calibration the sensor's cables may be lengthened or shortened without affecting the integrity of the calibration.

The disadvantage is that the handheld needs all six wires connecting even if using a four wire strain bridge sensor.



Version 01.05 firmware allows the global override of 6-wire measurements and allows you to select 4-wire measurement.

See [Configuration Management](#)

See final wiring diagram in this section for true 4-wire measurement connections.

Wiring a Six Wire Strain Bridge Sensor

Where possible six core cable should be used to connect the strain bridge sensor directly to the PSD connector. If the cable has twisted pairs refer to the wiring table above where it is indicated which connections should share a twisted pair. Note that shield connections are described further on in this section. Also note that the extra two cores required for TEDs connection (If used) are not shown in the diagram.

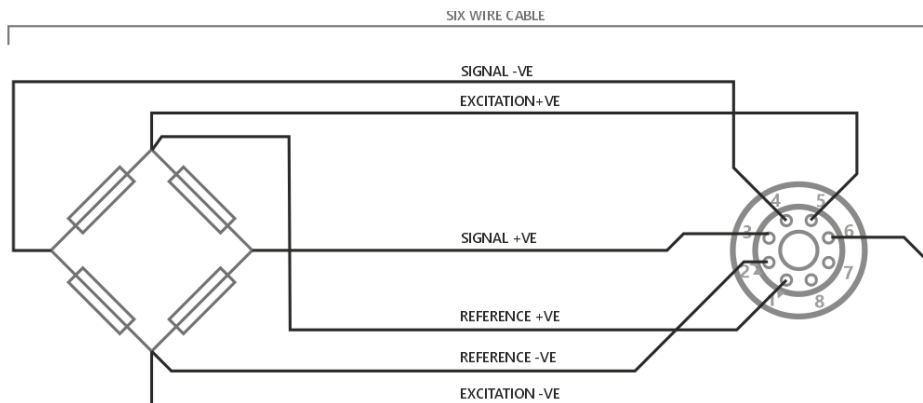

Wiring a Four Wire Strain Bridge Sensor (Existing four wire cable)

If it is not possible to run six core cable direct to the strain bridge sensor, or the strain bridge sensor is supplied with four core cable connected, then the sense connections will need to be made at the PSD connector end. See previous section for recommended method of connecting a single core cable to two connector pins.

If the cable has twisted pairs refer to the wiring table above where it is indicated which connections should share a twisted pair. Note that shield connections are described further on in this section.

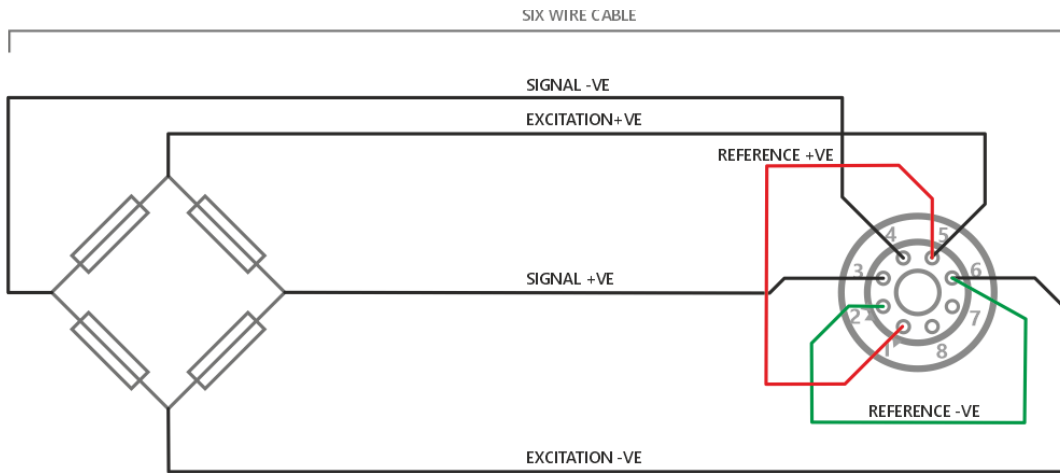

Wiring a Four Wire Strain Bridge Sensor (On extended six wire cable)

If a strain bridge sensor has four core cable fitted and a longer cable is needed to be attached then six core cable should be used to route up to the four core.

If the cable has twisted pairs refer to the wiring table above where it is indicated which connections should share a twisted pair. Note that shield connections are described further on in this section. Also note that the extra two cores required for TEDs connection (If used) are not shown in the diagram.

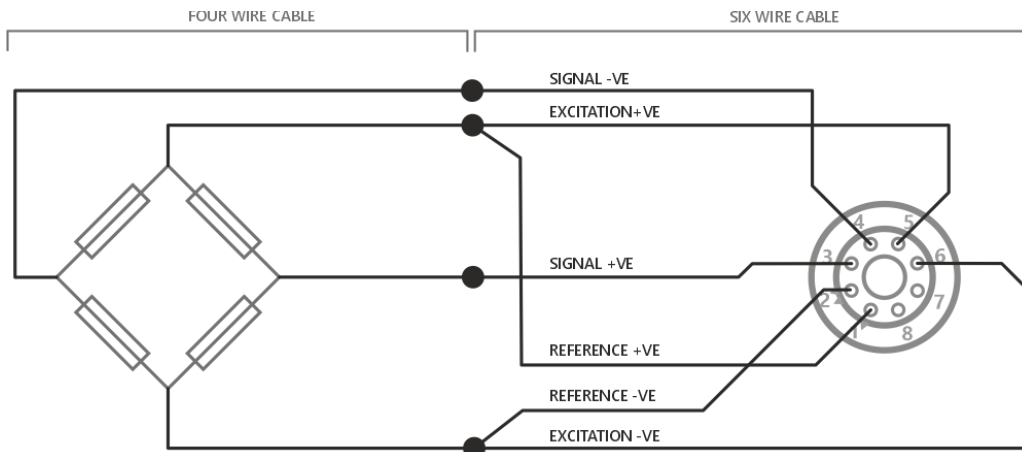

Wiring a Four Wire Strain Bridge Sensor When Four Wire Measurement Configured

Where possible four core cable should be used to connect the strain bridge sensor directly to the PSD connector. If the cable has twisted pairs refer to the wiring table above where it is indicated which connections should share a twisted pair. Note that shield connections are described further on in this section. Also note that the extra two cores required for TEDs connection (If used) are not shown in the diagram.

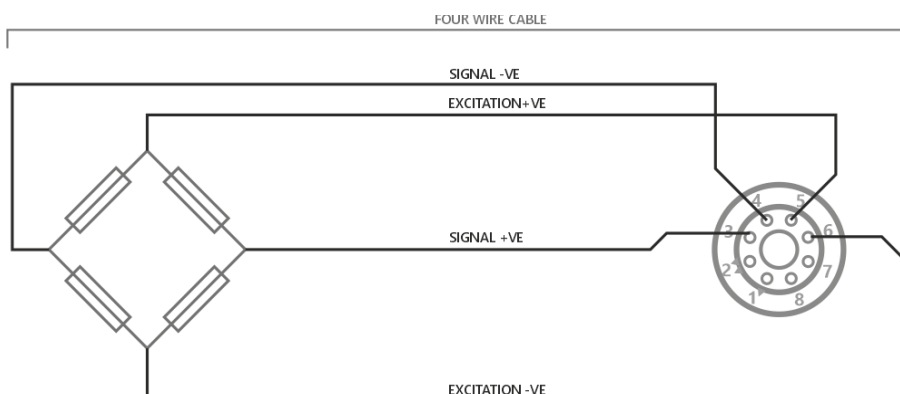

Shield Connection

All connection cables should be shielded / screened and the recommended shield connection point is as follows:

Where Strain Bridge Sensor Chassis is Metallic (or surrounding strain bridge sensor structure)

Cable shield should be connected to the strain bridge sensor chassis and remain unconnected at the PSD end.

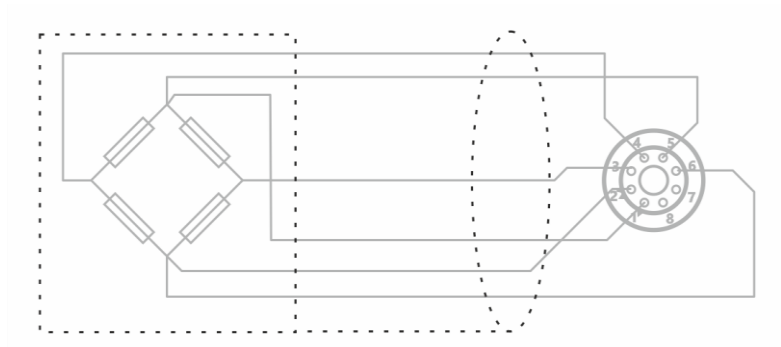

Where There is No Option to Connect to Strain Bridge Sensor Chassis

Cable shield should be connected to the PSD **Excitation -ve** and remain unconnected at the strain bridge sensor end.

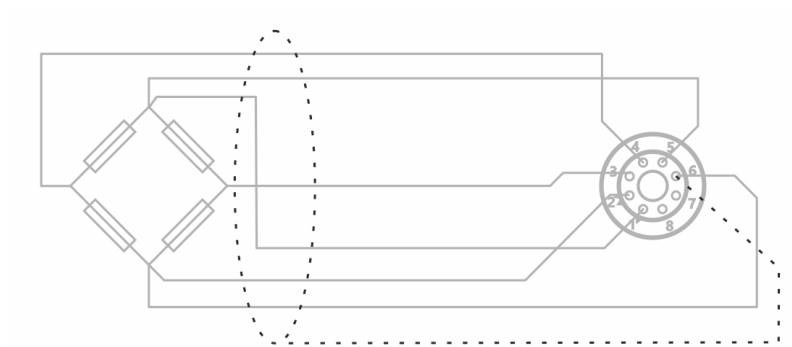

Toolkit Configuration

The toolkit (Windows 10 & 11) is used to configure the handheld and offer many more configuration options than the in-built menu system of the handheld itself.

Everything that the user can interact with in the Toolkit is highlighted in the blue accent colour.

Home

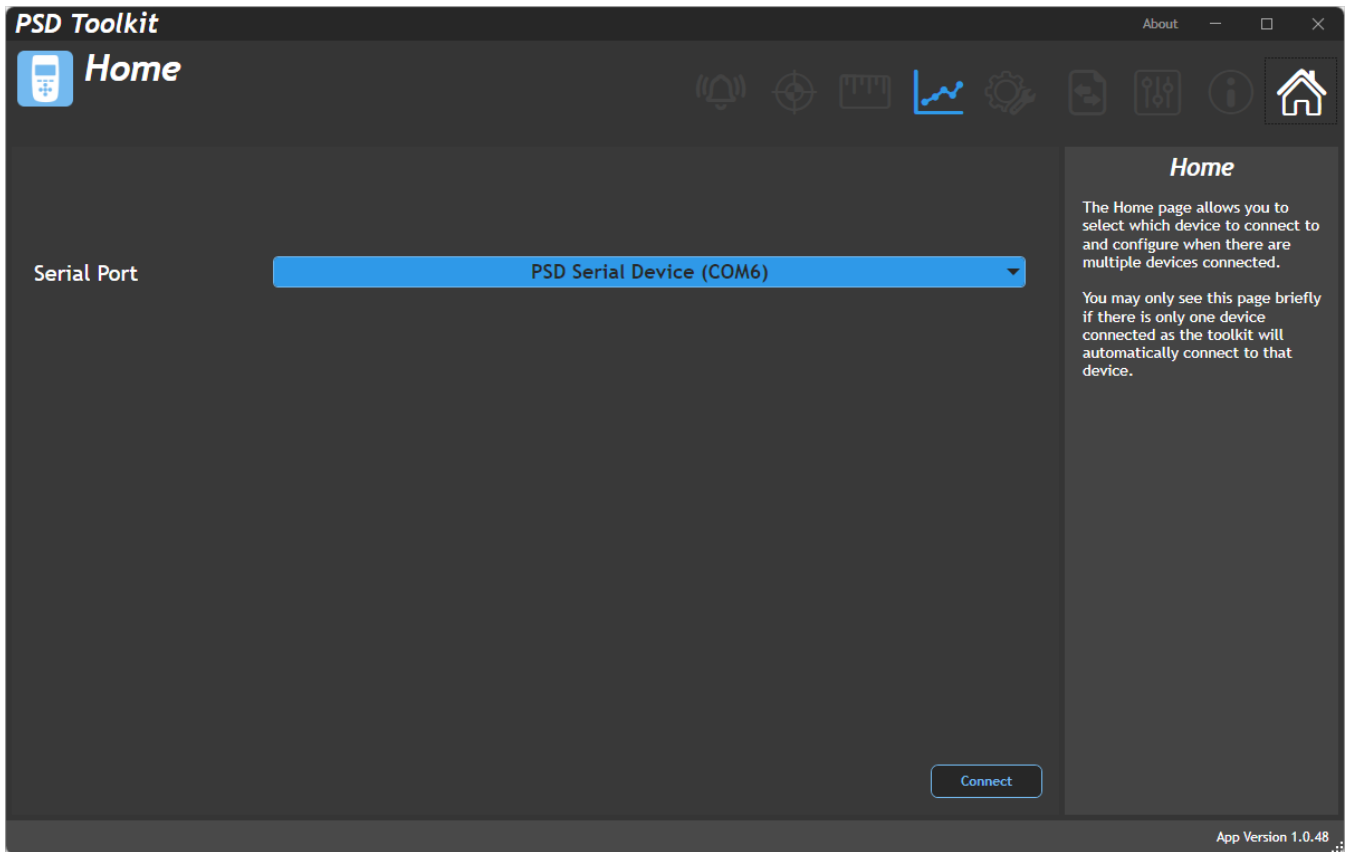

When you connect the handheld to the PC using a USB cable it creates a virtual COM port on the PC. All detected PSD devices are displayed in the drop-down list and you need to select the appropriate one. If only one handheld is detected you may not see this page as the Toolkit will automatically select and connect to it. After selecting the Serial port click the Connect button.

i Pressing F12 will toggle on/off the information panel displayed on the right of the window.

| Item | Description |
|------------------------------|--|
| Serial Port drop-down | Select from the list of detected serial ports. Select the one that the handheld is connected to. |
| Connect button | Connect to the device using the selected serial port. |

Information

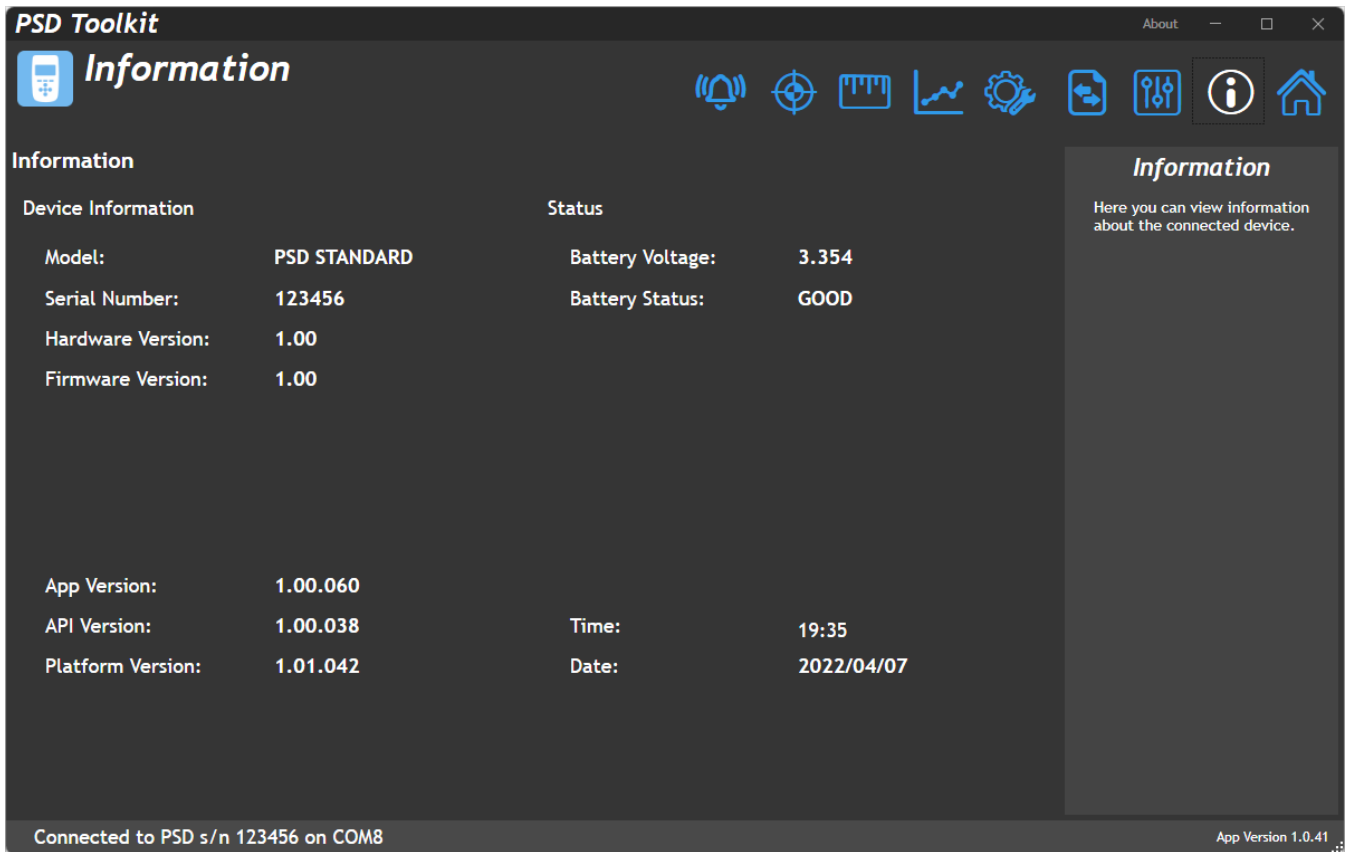

This page displays useful information about the connected handheld.

Settings

This page allows you to alter the device settings.

Interface Tab

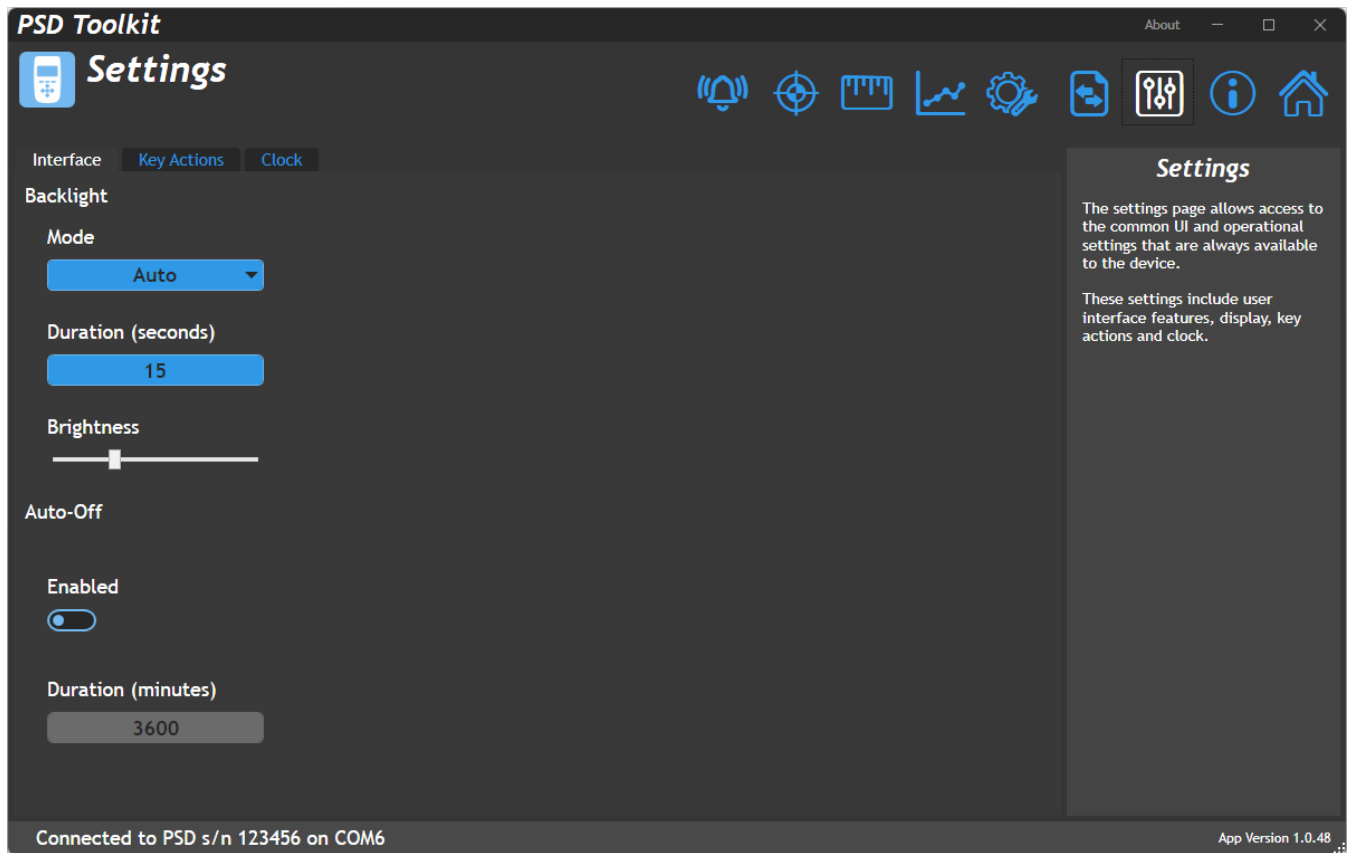

Here you can configure the user interface of the handheld and change settings of the backlight and keypad.

| Item | Description |
|--|--|
| Backlight | |
| Mode drop-down | Select the required operational mode for the backlight. Choices are: Off The backlight remains off On The backlight is on all the while the handheld is turned on Auto The backlight will come on when a key is pressed and turn off again if no key is pressed for the duration set below |
| Duration (s) entry field | Set the time to wait without a key press before the backlight turns off. Only applies if Mode is set to Auto. |
| Brightness slider | Change backlight brightness. Move the slider to set the desired backlight brightness level. A brighter backlight will result in lower battery life. |
| Auto-Off | |
| Enabled switch | Set to ON to automatically turn off the handheld if keys are not pressed for a specified duration. |
| Duration (minutes) entry field | Set the time to wait without a key press before the backlight turns off. Only applies if Auto-Off is enabled. |

Key Actions Tab

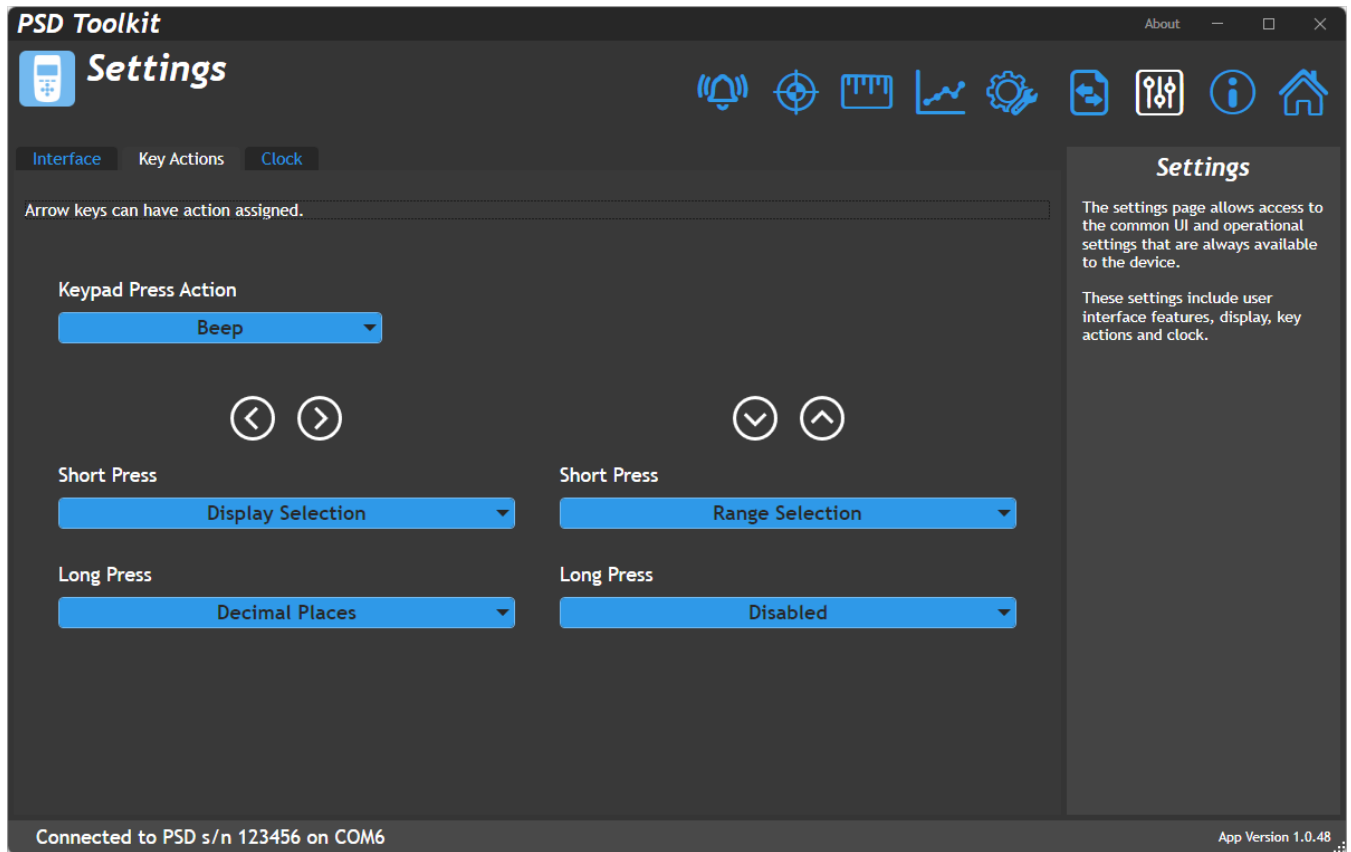

Here you can configure the user interface of the handheld and change settings of the keypad actions and functions.

Note that the left, right, up and down key action options may not be available on some handhelds.

| Item | Description |
|--|---|
| Keypad Press Action drop-down | Select the required action when a key is pressed: <ul style="list-style-type: none"> None Make no sound Beep Briefly sound the buzzer |
| Left/Right Short Press drop-down list | Select the action to take place when the keypad Left/Right keys are pressed. <ul style="list-style-type: none"> Range Selection Select the next Calibration Range. Display Selection Select the next Display Mode. Decimal Places Increase or decrease the number of decimal places displayed for all displayed values using the same units as the main display. Disabled No action. |
| Long Press drop-down list | Select the action to take place when the keypad Up/Down keys are pressed and released after approximately two seconds. <ul style="list-style-type: none"> Range Selection Select the next Calibration Range. Display Selection Select the next Display Mode. Decimal Places Increase or decrease the number of decimal places displayed for all displayed values using the same units as the main display. Disabled No action. |
| Up/Down | |

| | |
|--|---|
| <p>Short Press drop-down list</p> | <p><i>Select the action to take place when the keypad Up/Down keys are pressed.</i></p> <p>Range Selection Select the next Calibration Range. Display Selection Select the next Display Mode. Decimal Places Increase or decrease the number of decimal places displayed for all displayed values using the same units as the main display. Disabled No action.</p> |
| <p>Long Press drop-down list</p> | <p><i>Select the action to take place when the keypad Up/Down keys are pressed and released after approximately two seconds.</i></p> <p>Range Selection Select the next Calibration Range. Display Selection Select the next Display Mode. Decimal Places Increase or decrease the number of decimal places displayed for all displayed values using the same units as the main display. Disabled No action.</p> |

Clock Tab

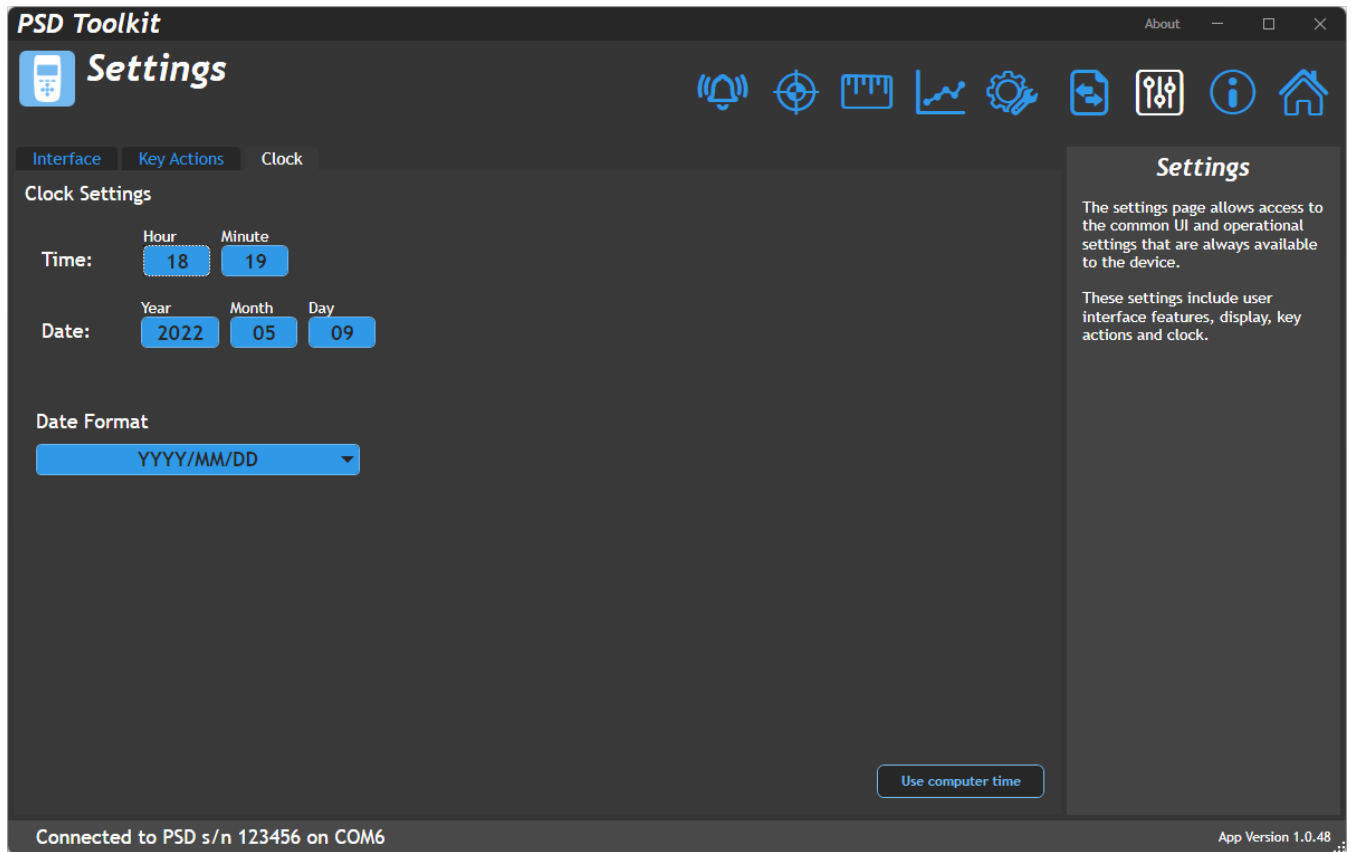

Here you can configure the device real-time clock.



NOTE: If the batteries are removed for more than half an hour (and the handheld is not being powered by USB) the real time clock may need resetting after the new batteries are fitted.

| Item | Description |
|--------------------------------------|---|
| Hour entry field | Set the handheld internal clock hour. |
| Minute entry field | Set the handheld internal clock minute. |
| Year entry field | Set the handheld internal clock year. |
| Month entry field | Set the handheld internal clock month. |
| Day entry field | Set the handheld internal clock day. |
| Date Format Drop-down list | Select the desired date format. |
| Use Computer Time button | Set handheld to PC time and date. |

Import / Export

This page allows you to export the settings from the connected device for later import into the same, or another, device. Depending on whether certain sections are locked you may not be allowed to export.

There are two ways to export data:

Standard Export – allows all settings that are not locked to be exported and then on import the user can choose which sections to overwrite. It is good practice to retain a copy of the exported settings file in case settings need to be restored in the future. Also note that technical support may ask for this file to aid trouble shooting.

Clone Export – The entire device is exported and on import will create a clone of the original device. Any locked/protected sections are still respected so no exports can be made from a locked device nor can a locked device be overwritten without knowledge of the passwords.

Export Tab

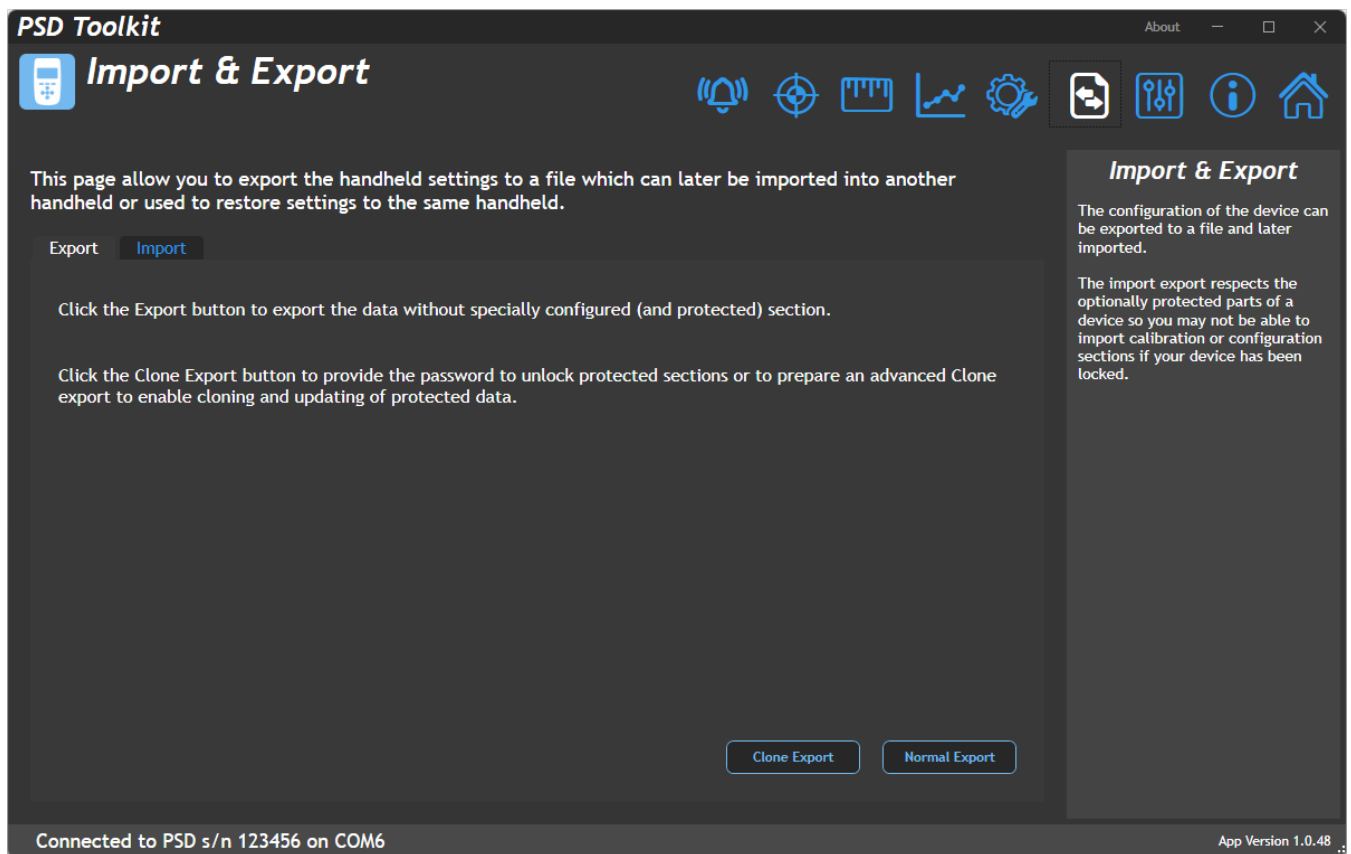

This page allows you to perform a simple Export or an advanced Clone Export.

Export – This exports device settings to a file on the PC which will contain all data except for configuration data if that section has been locked.

Clone Export – See the next section in the manual.

Also see Import later in the manual for information about using these exported data files.

| Item | Description |
|----------------------------|--|
| Export button | Export configuration to a file on the PC. This will open a file dialog box to allow you to specify where the export will be saved. |
| Clone Export button | See the next section in the manual. |

Export Tab – Clone Export

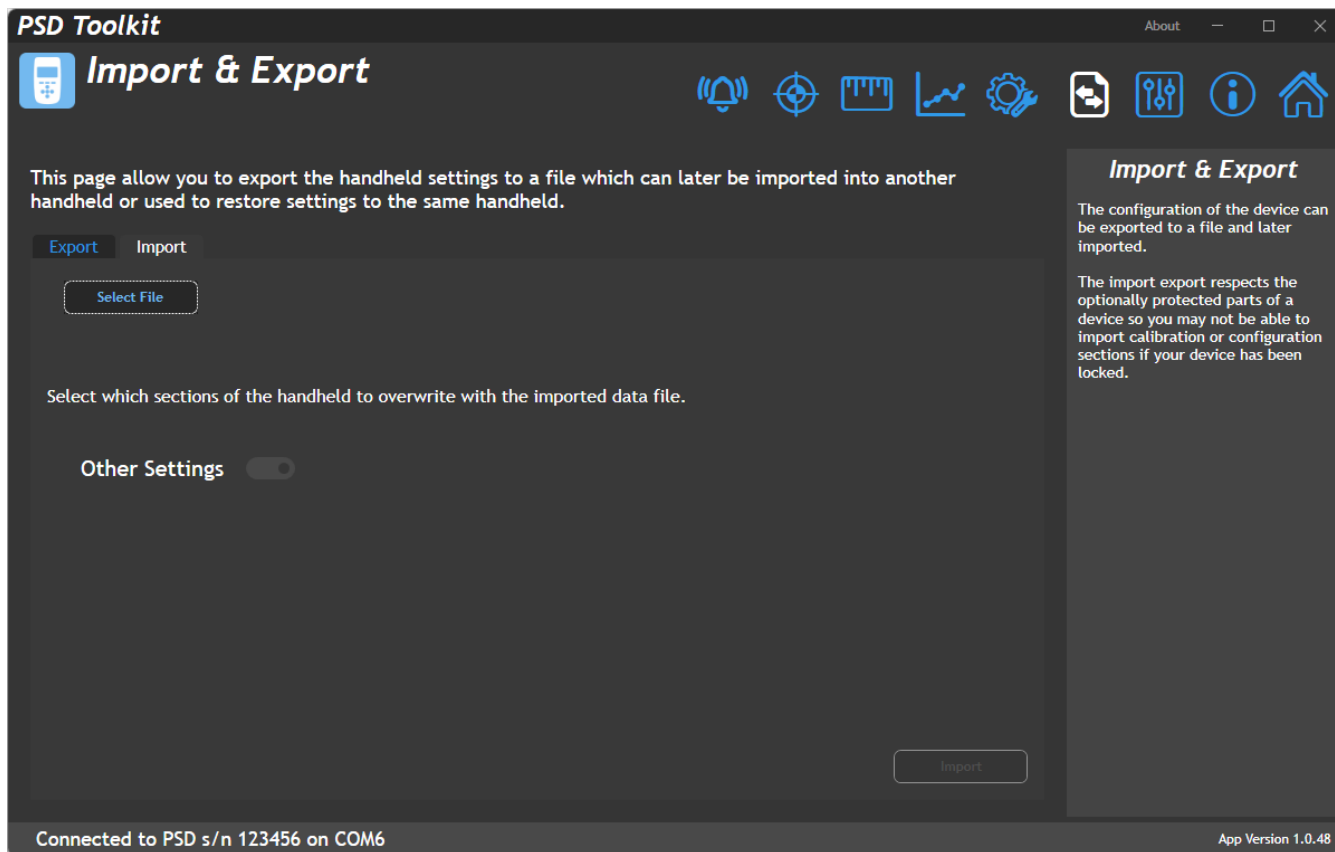

Clone Export is an advanced form of export that offers the ability to export data that may be locked and protected by a password and also allows passwords to be encrypted into the exported file and get applied to the freshly cloned device when imported.

When creating the Clone Export file an optional password may be supplied to automatically apply protection to the cloned device when imported.



It is important that these passwords are not forgotten. Resetting of a forgotten password will require proof of access rights and may require a return to supplier and may incur additional cost.

If the connected device has a password locked calibration or configuration section then the same passwords **must** be entered to proceed.

Summary: To successfully create a Clone Export the connected device must be unlocked or the passwords known for those locked sections. If a section is currently unlocked, then a password may be supplied at this point to be automatically applied to the cloned device later.

| Item | Description |
|----------------------------|--|
| Back button | Go back to standard export page. |
| Clone Export button | Export Clone configuration to a file on the PC. This will open a file dialog box to allow you to specify where the export will be saved. |

Import Tab

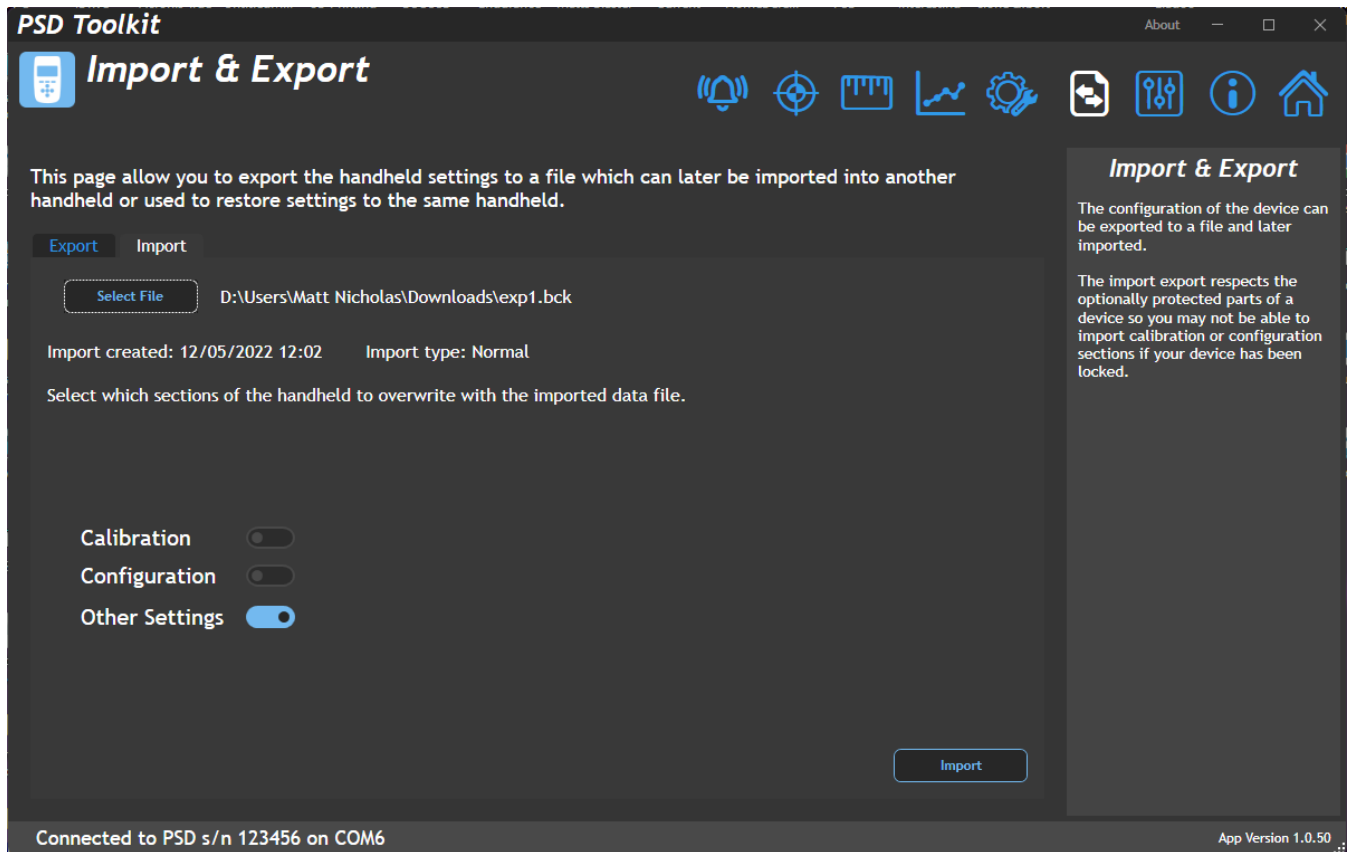

This page allows you import a previously exported file.

The file you choose may be one of two types and this may present further options depending on its type.

Standard Export File

You can choose which sections to import. The choices available will depend on whether they are present in the data file and whether those sections are protected in the connected device itself.

Calibration – Calibration settings

Configuration – The configuration which includes what settings are available to change, which menu items are visible etc. This also includes the Display Modes.

Settings – All general settings.

Clone Export File

To successfully import a Clone Export file, either the calibration and configuration sections must be unprotected in the connected device or the passwords encrypted in the data file must match those in the protected sections of the connected device.

After selecting the file the toolkit will inform you whether the data can be imported and if it can you can chose to click the Import button to perform the cloning action.

When cloning a handheld, all configuration, user calibration and user settings are duplicated leaving only the original factory settings and factory calibration intact

NOTE: If the Clone Export file contains encrypted passwords to protect either the calibration or configuration sections then it must be understood that those sections will become locked in the connected device once the data file is imported. There is no way to unlock a protected section if the password is unknown (Resetting of a forgotten password will require proof of right to access and may require a return to supplier and incur additional cost.) so be sure that the source of the Clone data file is trusted or that you know the passwords yourself. (It is normal for a provider of a locked down device to provide a Clone data file that can update that device.)

| Item | Description |
|------------------------------|--|
| Select File button | <i>Click to open a file select dialog box to allow you to choose the location of the file to import.</i> |
| Import button | <i>Perform the import.</i> |

Configuration

The configuration page is very important to enable you to tailor the functionality of the handheld to your requirements and to optionally lock down those settings.

Once locked with a password these settings cannot be changed either from the handheld itself or the Toolkit unless the user knows the password.

This also applies to imported files. A user cannot overwrite the settings of a handheld from a previously exported settings file without knowing the password.

This section may have been locked with a password. In this case then the padlock icon will indicate locked and not all tabs will be visible. To unlock the section, click on the padlock icon and enter the correct password.

Menus Tab

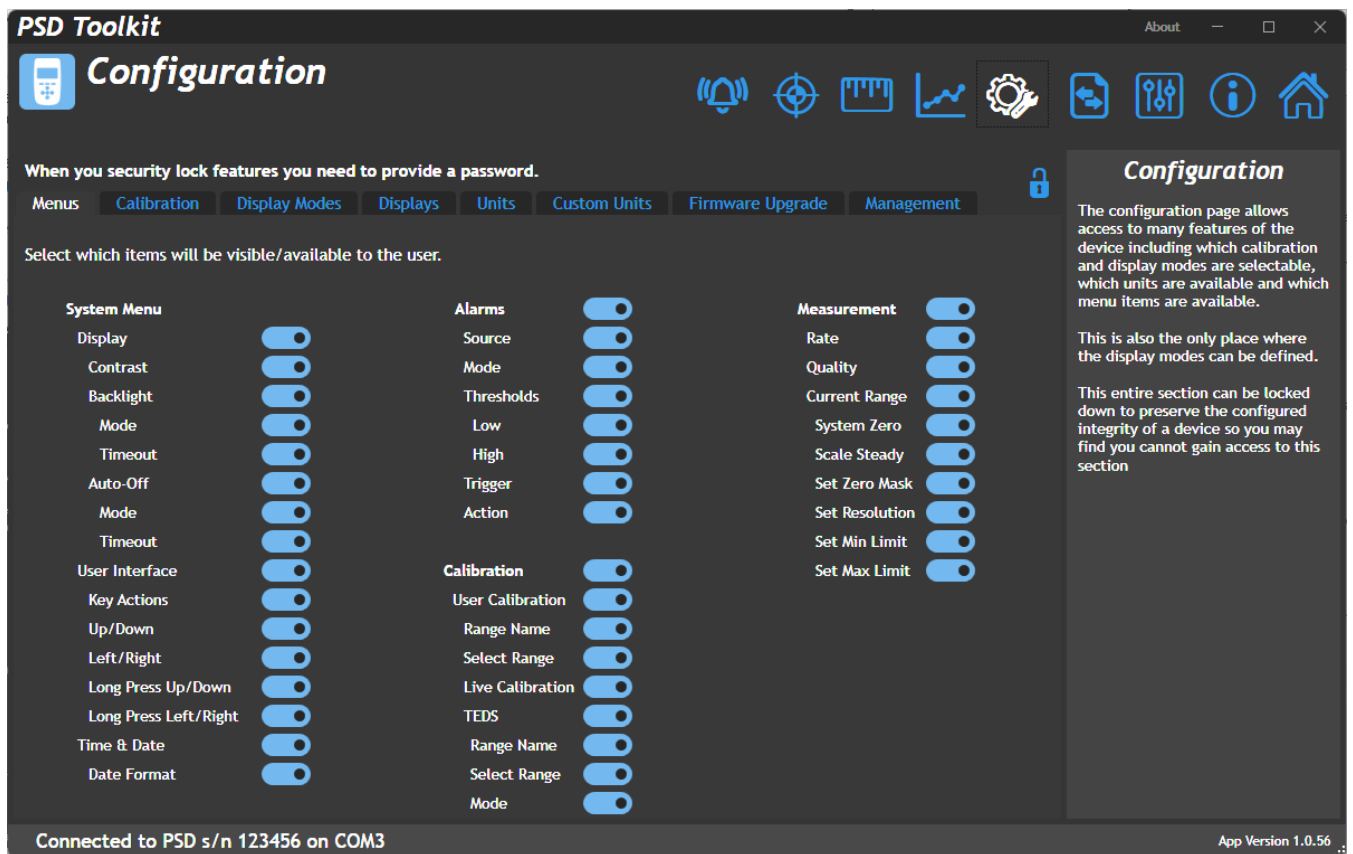

This tab allows you to select which menu items are available from the handheld.

Refer to the Menu Structure section to see what functionality the above menu options contain.

Note that individual menu items (Those not shown above) are not available for individually hiding.

 **Off** – Menu item will be hidden

 **On** – Menu item will be visible

Calibration Tab

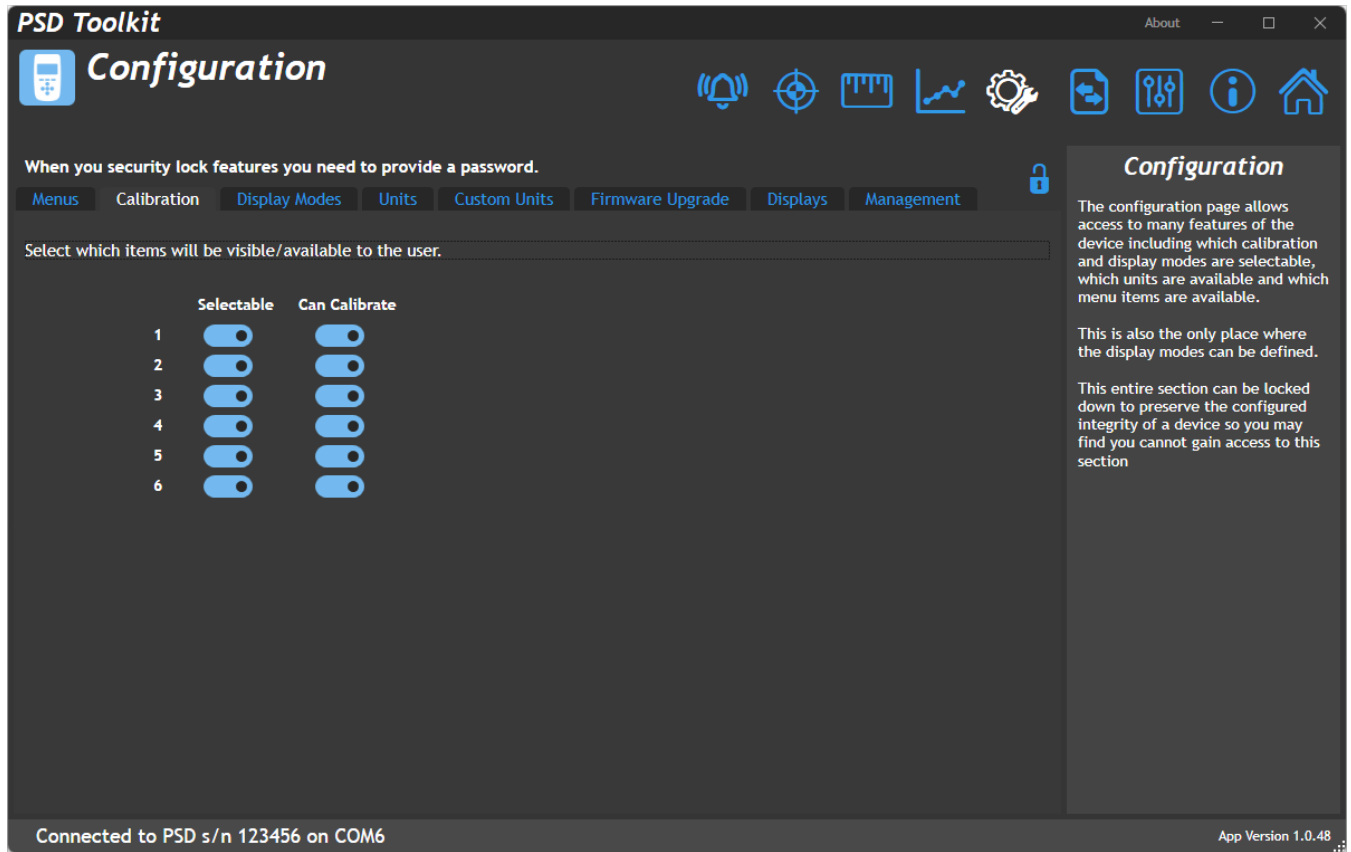

This section allows you to configure the available six calibration ranges availability from the menu and whether the range is selectable via the keypad (If that keypad action has been enabled).

For the internal six calibration ranges you can choose whether each is selectable and calibratable.

Selectable

- Off** – Calibration range will *not* be selectable via menu or keypad.
- On** – Calibration range will be selectable via menu or keypad.

Can Calibrate

- Off** – This calibration range *cannot* be calibrated by the user.
- On** – This calibration range can be calibrated by the user.

The calibration availability is useful for providing preset calibration ranges that cannot be recalibrated, whilst still allowing other ranges to be calibrated by the user.

Display Modes Tab

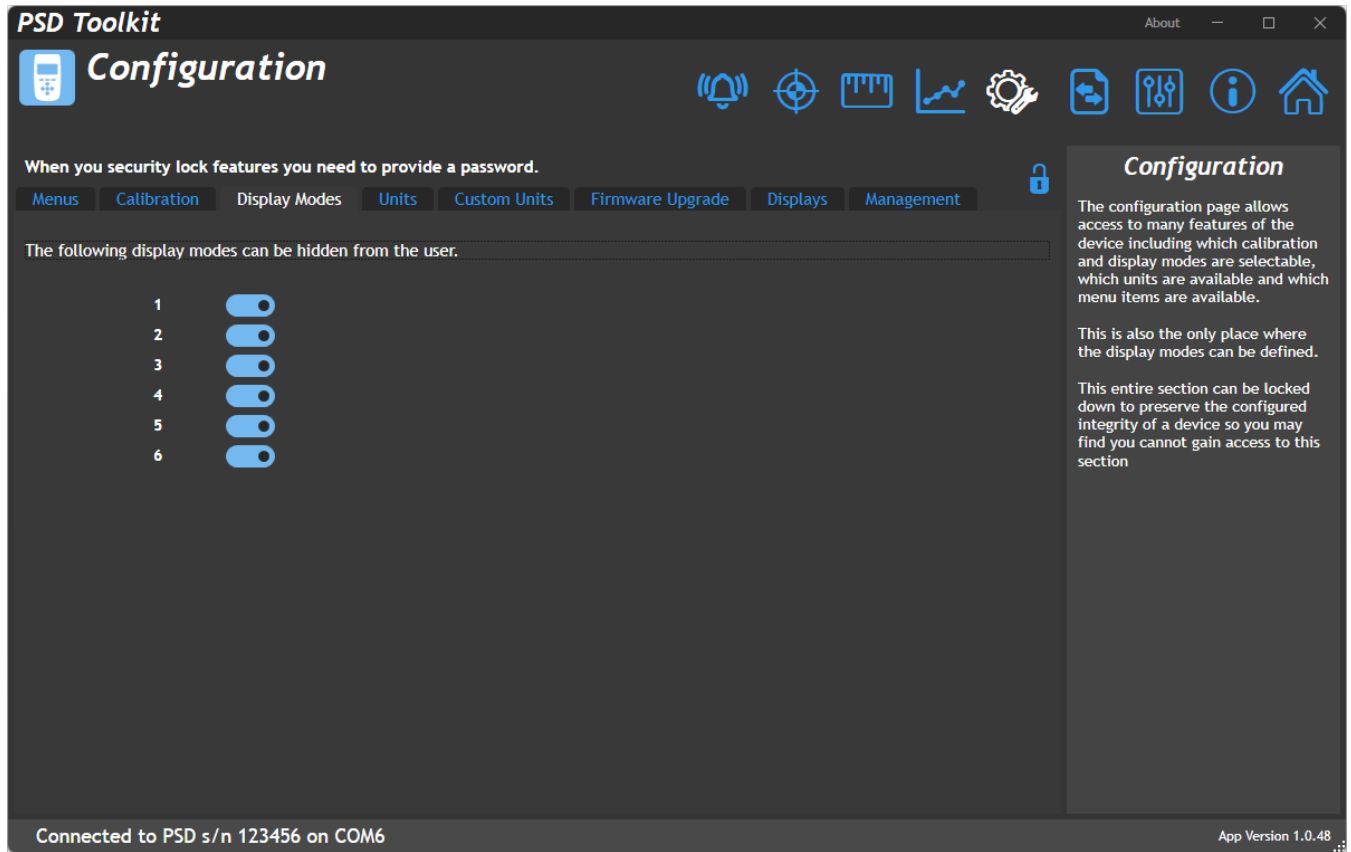

This section allows you to enable or disable the available six display modes from selection using the keypad (If that functionality has been configured)

Note that future display modes may provide the ability to select other modes via the soft keys. The selection options here will not stop that action but only the selection from the keypad.

 **Off** – Display Mode is *unavailable* for selection.

 **On** – Display Mode is available for selection.

Units Tab

PSD Toolkit Configuration

When you security lock features you need to provide a password.

Menus Calibration Display Modes Units Custom Units Firmware Upgrade Displays Management

Available units

| Unit | Name |
|------------|-------------------|
| ▲ Angle | |
| | circumference |
| | grade |
| | minutes |
| | seconds |
| rev | revolutions |
| ▲ Distance | |
| Å | angstrom |
| AU | astronomical unit |
| ch | chains gunters |
| ell | ell |
| em | em |
| fm | fathoms |
| fur | furlongs |
| in | inches |
| km | kilometers |
| lea | league |
| league | leagues |

Selected units

| Unit | Name | Decimal Places |
|-----------------|-----------------|----------------|
| ▲ Voltage Ratio | | |
| mV/V | milliVolts/Volt | 0.000 |
| V/V | Volts/Volt | 0.000 |
| µV/V | microVolts/Volt | 0.000 |
| ▲ Angle | | |
| rad | radians | 0.000 |
| ° | degrees | 0.000 |
| ▲ Distance | | |
| m | meters | 0.000 |
| cm | centimeters | 0.000 |
| ft | feet | 0.000 |
| yd | yards | 0.000 |
| ▲ Mass | | |
| kg | kilograms | 0.000 |
| g | grams | 0.000 |
| oz | ounces | 0.000 |
| lb | pounds | 0.000 |

Configuration

The configuration page allows access to many features of the device including which calibration and display modes are selectable, which units are available and which menu items are available.

This is also the only place where the display modes can be defined.

This entire section can be locked down to preserve the configured integrity of a device so you may find you cannot gain access to this section

Connected to PSD s/n 123456 on COM6

App Version 1.0.48

This section allows you to define which units of measure are available for calibration as the base engineering units and also any unit conversions that are selectable from the Units soft key that appears on most display modes. Two lists are displayed. The left one shows all available units that are *not* currently enabled and the one on the right shows the units that are available for calibrating or conversion. To change items between the two lists simply select one or more items (Hold CTRL keyboard key to select multiple items) and click the appropriate arrow symbol.

When the user uses the Units soft key to cycle around selected units the list will be limited to those that are relevant to the calibrated base units.

Each unit has a definable display format that sets the desired number of decimal places shown. The format can be changed here by right clicking the field in the Decimal Places column and selecting the desired format from the pop-up list.

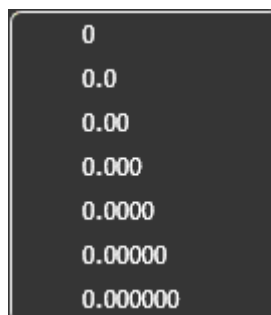

Note that the decimal places can also be modified (globally for the currently displayed engineering units) by using a long press on the keypad left and right direction keys (If this action has been allowed).

Custom Units Tab

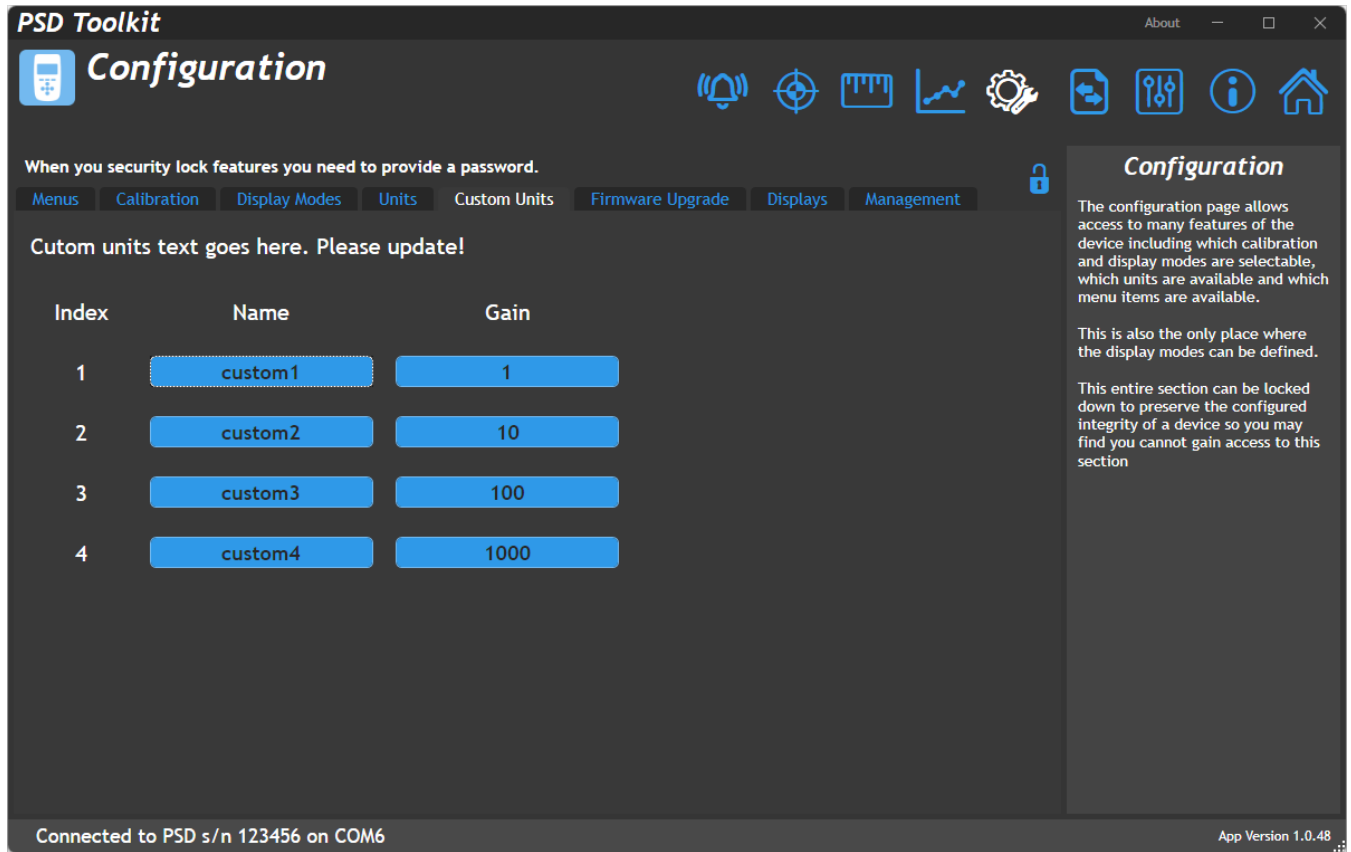

If the comprehensive list of built in units and automatic conversion does not contain the engineering units you need then this tab allows you to create your own.

You can create up to four units with a gain factor for each to allow conversion between them.

See the Engineering Units section for a list of supported unit categories and units. You will notice the four custom units at the end of the table. These are selectable as either calibrated or available display units and the conversion factors used and the description shown will come from the data entered here.

| Item | Description |
|----------------------------|---|
| Index label | Indicates the index of the custom unit. |
| Name entry field | <i>Enter the text to be displayed for this custom unit. i.e. kg, lbs etc.</i> |
| Gain entry field | <i>Enter a gain value for this custom unit. The gain value indicates how to convert between the different custom units. For example, if you were trying to enter mass units and wanted kg and lbs you could enter kg in index 1 with a gain of 1 and lbs in index 2 with a gain of 2.2.</i> |

Firmware Upgrade Tab

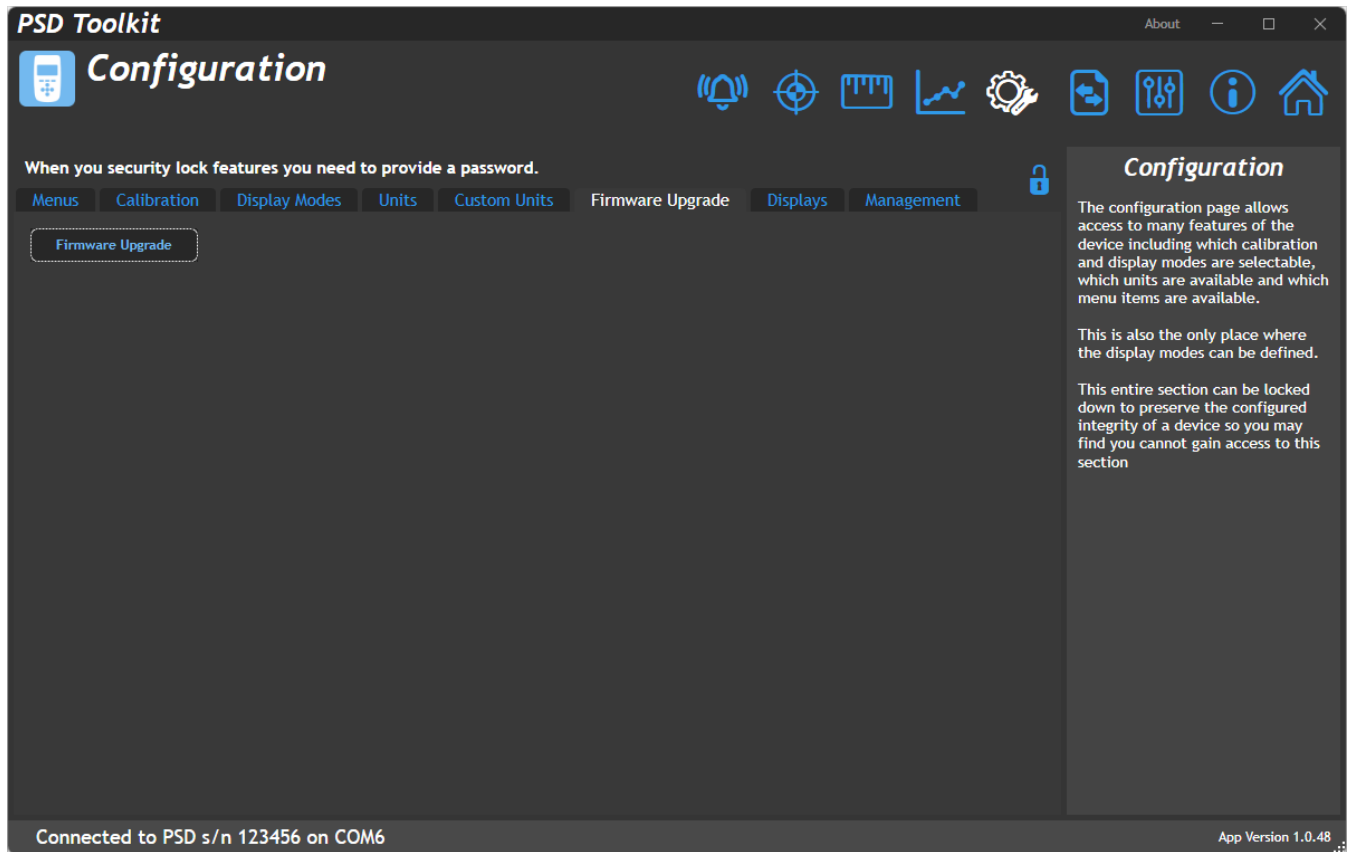

This section allows the firmware in the handheld to be updated.

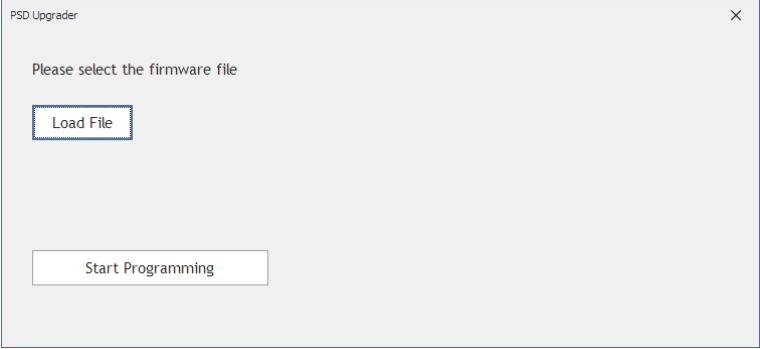

The toolkit must be launched using the 'Run As Administrator' option to enable firmware update to work.

| Item | Description |
|-----------------------------------|--|
| Firmware Upgrade button | <p>Click the button to open the upgrader window.</p>  <p>The screenshot shows a dialog box titled "PSD Upgrader" with a close button (X) in the top right corner. The text inside reads "Please select the firmware file". Below this text are two buttons: "Load File" and "Start Programming".</p> <p>Click Load File button to select the .src firmware file. Click Start Programming to initiate the update, then follow onscreen instructions. (Remove all power from the device before attempting to reconnect.)</p> |

Displays Tab

This tab allows Display Modes to be assigned to the six available slots. A selection of display modes are shipped with the Toolkit software and custom modes may be imported if you have been supplied a display mode update file.

Summary Sub Tab

This tab shows which Display Mode has been selected for each of the six available slots. The currently selected Display Mode of the handheld is indicated by the display number being shown in triangular brackets. The right-most column shows a graphical mimic of how the display is formatted.

The screenshot shows the 'PSD Toolkit Configuration' window. The 'Displays' tab is active, showing a table of six display modes. The first mode, 'Simple Mode', is selected and indicated by '< 1 >' in the 'Display' column. To the right of the table, a 'Configuration' sidebar provides additional information and a lock icon. At the bottom, the status bar shows 'Connected to PSD s/n 123456 on COM6' and 'App Version 1.0.48'.

| Display | Name | Description | Image |
|---------|--------------------|---|-------|
| < 1 > | Simple Mode | Switch between Gross & Net (Factory display 1) | |
| 2 | Cumulative Zeroing | Cumulative zeroing or Gross value (Factory display 2) | |
| 3 | Hold | Hold the live value (Factory display 3) | |
| 4 | Min/Max | Track min/max value (Factory display 4) | |
| 5 | Delta | Track min/max value and display Delta (Factory display 5) | |
| 6 | Pass/Fail | Pass/fail indication using alarm settings (Factory display 6) | |

Configuration

The configuration page allows access to many features of the device including which calibration and display modes are selectable, which units are available and which menu items are available.

This is also the only place where the display modes can be defined.

This entire section can be locked down to preserve the configured integrity of a device so you may find you cannot gain access to this section

Connected to PSD s/n 123456 on COM6 App Version 1.0.48

Mode 1...6 Sub Tab

This page shows which Display Mode is selected for each of the available Display Mode slots.

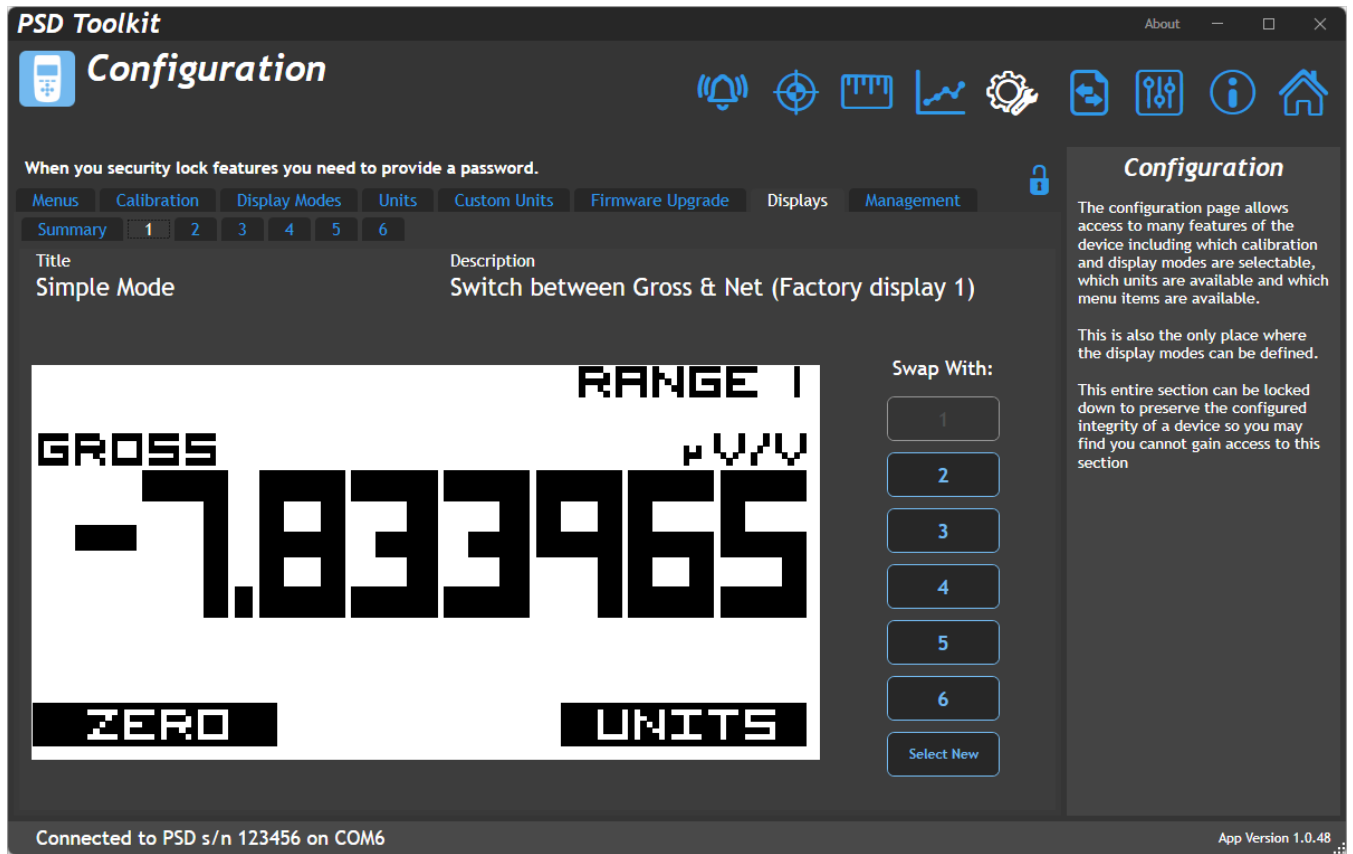

Configure the available Display Mode slots with the required Display Modes.

| Item | Description |
|-----------------------------|--|
| Title label | <i>Displays the title of the display mode currently selected for this slot.</i> |
| Description label | <i>Displays the description of the display mode currently selected for this slot.</i> |
| Swap With buttons | <i>Swap the current display mode with the one in another slot.</i> |
| Select New button | <i>Select a new display mode for the current slot. See the next section for a description of this process.</i> |

Select New

This pop-up dialog shows all available Display Modes that can be assigned to the currently selected Display Mode Slot. The Toolkit is installed with a library of available Display Modes but also offers the ability to import a custom Display Mode from a file.

Custom files may be sent to you by your supplier and once imported will remain in the list of available Display Modes.

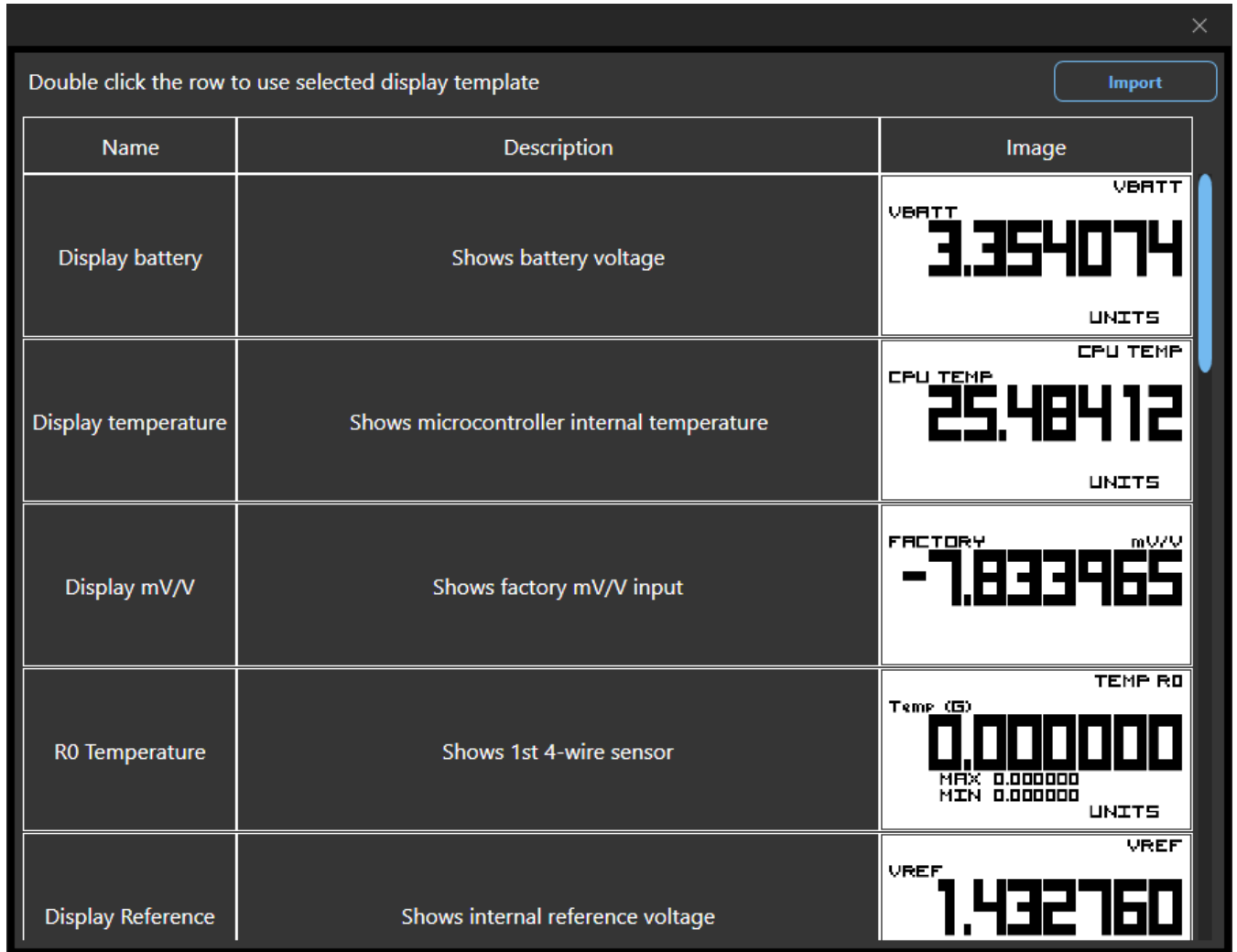

Here you can configure the user interface of the handheld and change settings of the backlight and keypad.

| Item | Description |
|----------------------------|---|
| Display Mode row | <i>Displays the title and description of the display mode currently selected for this slot.</i> |
| Import button | <i>Opens the file dialog window to allow a Display Mode Descriptor file to be located and imported. Display Mode Descriptor files have an .ies file extension.</i> |

Management Tab

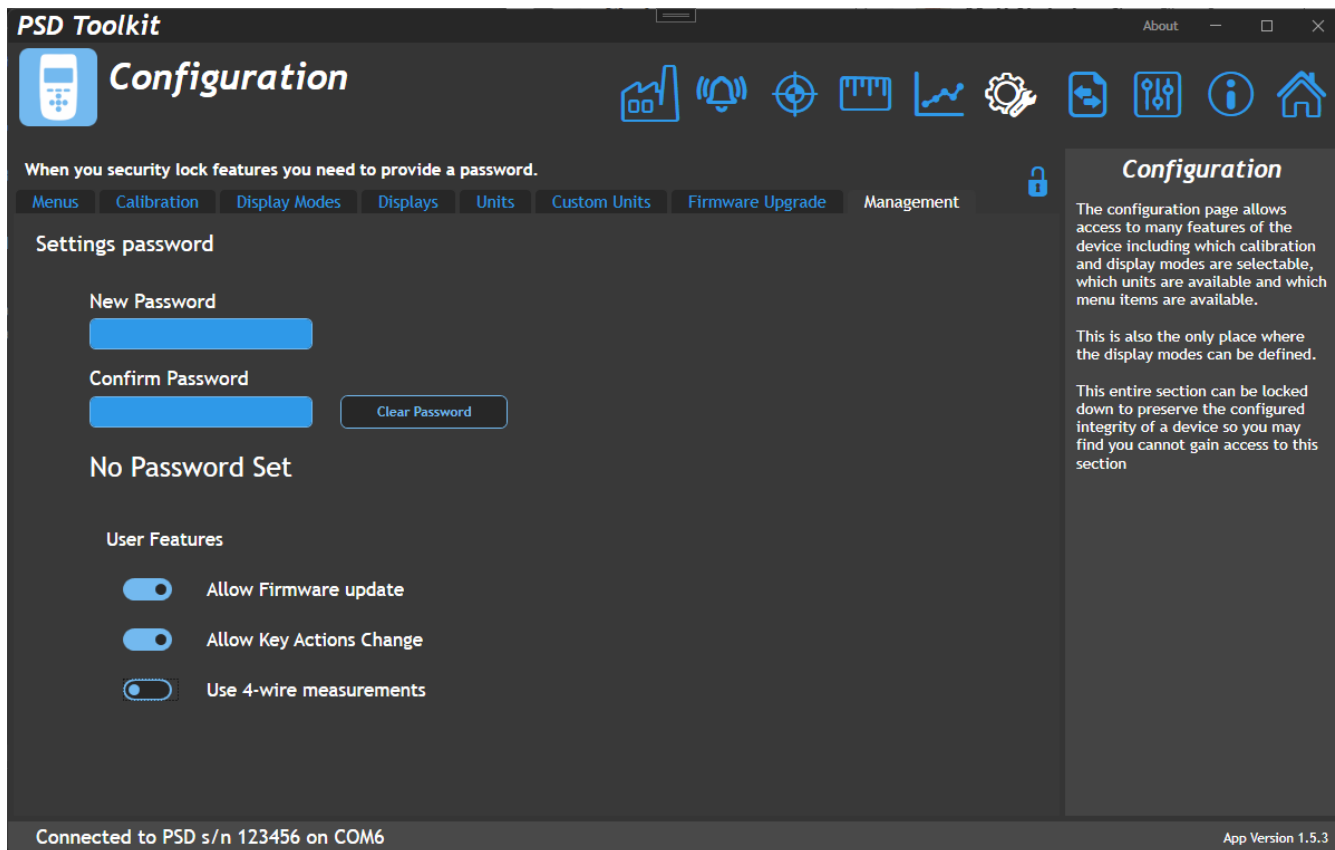

Access to the entire set of Configuration settings can be locked with a password. Without the password a user cannot change any of the protected settings which include the available Display Modes. This tab allows setting a new password or removing an existing password to protect or release the configuration settings.

! There is no way to unlock a protected section if the password is forgotten!
 Resetting of a forgotten password will require proof of right to access and may require a return to supplier and incur additional cost.
DO NOT FORGET YOUR PASSWORD!

| Item | Description |
|-------------------------------------|---|
| New Password button | Allows a new password to be set to protect the configuration settings of the device. This field will be available whether a password exists or not. |
| Confirm Password button | The new password must be entered in this field as well as the previous field. |
| Set Password button | Click to set the password. |
| Clear Password button | If a password exists, click this button to remove it and to remove protection of the configuration settings. |
| User Features | |
| Allow Firmware Update switch | When set to off the user cannot upgrade the handheld firmware using the Configuration page when Configuration is locked with a password. |

**Allow Key Action
Change**
switch

When set to off the user cannot change the action assigned to the left, right, up and down keys on the Settings page.

**Use 4-Wire
Measurements**
switch



This allows you to globally override the normal 6-wire measurement system to allow the use of 4-wire input connections and saves having to short together the sense inputs when using 4-wire inputs on a 6-wire measurement system.
Note that when using 4-wire measurement the cable lengths will not be compensated for.

Logging



This page allows data from the handheld to be logged to a file and later reloaded to be viewed on the chart. A real-time chart is always visible whether logging is active or not.

| Item | Description |
|---------------------------------------|---|
| Source drop-down | Select the source value to log. |
| Log Interval (ms) drop-down | Select the interval between logs in milliseconds. Choices are: <ul style="list-style-type: none"> 10 Log every 10 milliseconds. 100 times per second (100 SPS). 20 Log every 20 milliseconds. 50 times per second (50 SPS). 50 Log every 50 milliseconds. 20 times per second (20 SPS). 60 Log every 60 milliseconds. 16.6 times per second (16.6 SPS). 100 Log every 100 milliseconds. 10 times per second (10 SPS). 200 Log every 200 milliseconds. 5 times per second (5 SPS). 500 Log every 500 milliseconds. 2 times per second (0.5 SPS). 1000 Log every 1000 milliseconds. 1 per second (1 SPS). |
| Log File entry field | Double-click to select the folder and filename for the logged file. |
| Start Logging button | Start logging. You will be warned if the file already exists and given the option to continue or cancel the operation. |

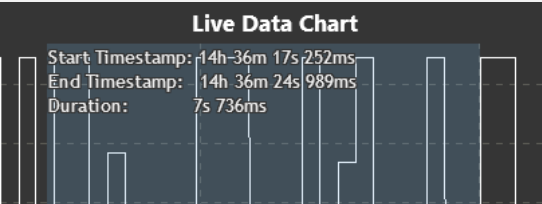
| | |
|---------------------------------------|---|
| <p>Chart chart</p> | <p>The chart itself can be clicked on and supports the following actions:</p> <p>Zoom In Performed by clicking and dragging to draw a box over the portion of the chart to zoom in on. To zoom in the mouse must move to the right after clicking.</p> <p>Zoom Out Zoom back out to the full chart view by clicking and dragging to draw a box. The mouse must move to the left after clicking to zoom out.</p> <p>Free Zoom Use the mouse wheel to zoom in or out focused at the position of the mouse pointer.</p> <p>Scroll Vertically Click and drag the Y axis (Value). Only useful when Autoscale is off.</p> <p>Free panning Click and drag the chart using the right mouse button to pan around the data. Only useful when Autoscale is off.</p> |
| <p>Pause icon</p> | <p>Toggles between paused and running. When paused the chart data is not lost and the chart will be populated with missing data when resumed again.</p> <div data-bbox="371 689 448 844" style="display: inline-block; vertical-align: middle;">   </div> <p>Click to pause chart.</p> <p>Click to resume chart.</p> |
| <p>Autoscale switch</p> | <p>Select whether to automatically scale the chart.</p> <p>Off Chart will not automatically scale to suit data as it is added. Click the Reset View button to perform a one off auto scale.</p> <p>On Chart will automatically scale to the data as it is added.</p> |
| <p>Show Value switch</p> | <p>Select whether to show information popup window as the mouse pointer hovers over data points</p> <p>Off Nothing is displayed.</p> <p>On Display pop-up information box showing the time and value of the data point under the mouse pointer.</p> |
| <p>Measure Time switch</p> | <p>Select whether to display the on chart tool for measuring the time between two horizontal points on the chart. This is made much easier if the chart is paused.</p> <p>Off Nothing is displayed.</p> <p>On The Measure Time tool is displayed. A vertical shaded box will appear and the sides can be dragged with the mouse to cover the desired part of the chart. The start and end timestamps along with the actual duration is then displayed.</p> <div data-bbox="699 1637 1243 1839" style="text-align: center;">  </div> |

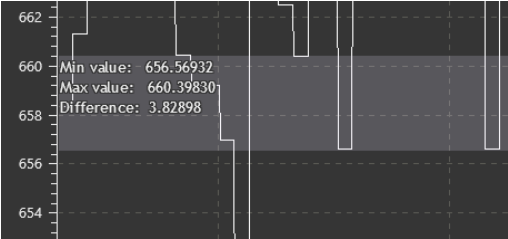
| | |
|--|---|
| Measure Value switch | <p>Select whether to display the on chart tool for measuring the value between two vertical points on the chart. This is made much easier if the chart is paused.</p> <p>Off Nothing is displayed.</p> <p>On The Measure Value tool is displayed. A horizontal shaded box will appear and the top and bottom can be dragged with the mouse to cover the desired part of the chart. The min and max values along with the actual difference between the two are displayed.</p> |
|  | |
| Show Min/Max switch | <p>Select whether to show lines to indicate the minimum and maximum value in the chart data.</p> <p>Off Nothing is displayed.</p> <p>On Min and max (Of the currently viewed data) lines are shown in red and green respectively.</p> |
| Load Log File button | <p>Opens a file dialog to allow you to select a previously logged data file. This file data will be loaded into the chart and can be viewed with all the tools available. The button caption will change to Back To Realtime Chart after the file has loaded.</p> |
| Clear Chart button | <p>Clear all data from the chart.</p> |
| Reset View button | <p>Returns the chart to its default view and zoom level after zooming or panning the chart.</p> |
| Back To Realtime Chart button | <p>This is what the caption of the Load Log File button changes to while a logged file is opened in the chart. Clicking the button will revert the chart to showing real-time data.</p> |

Measurement

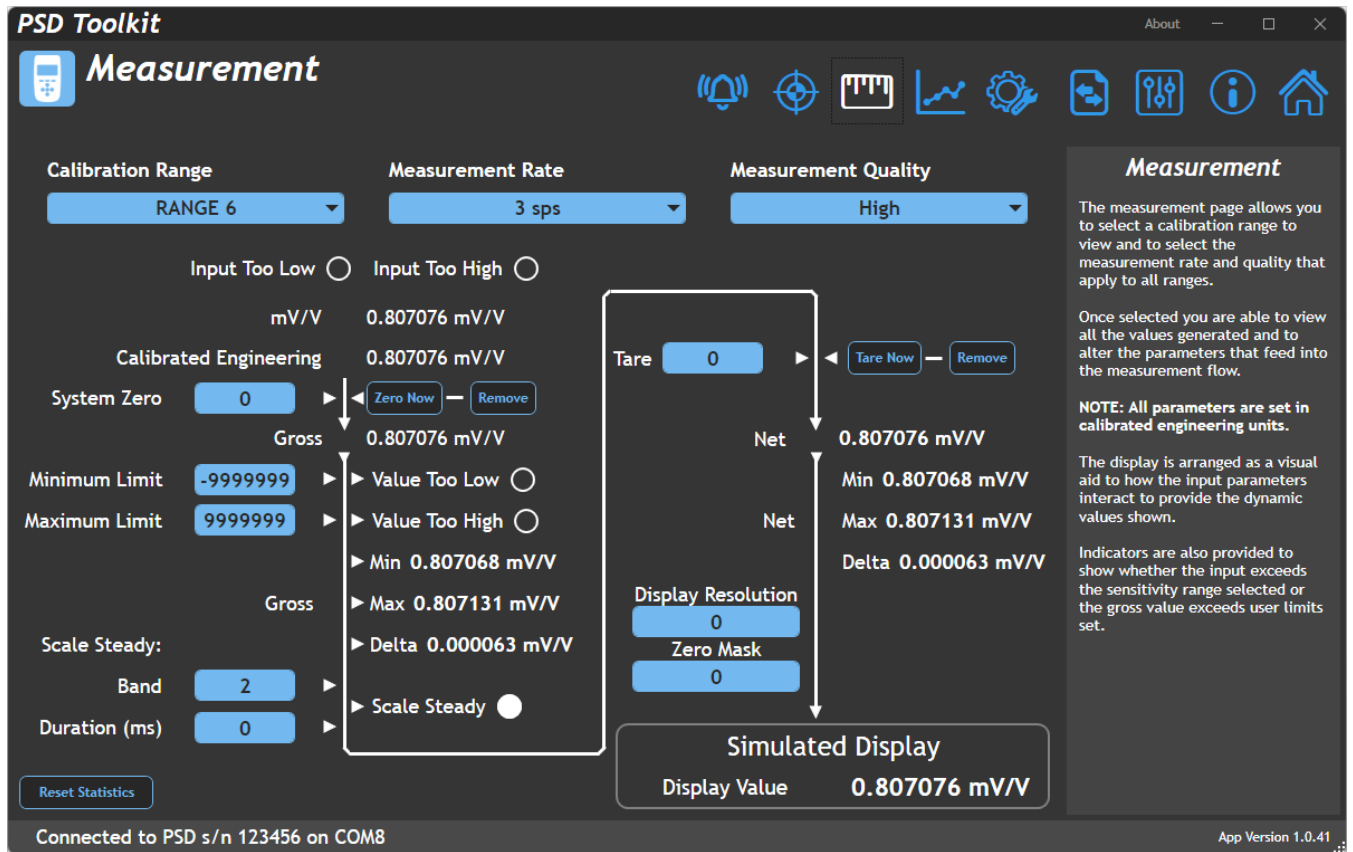

This page allows you to change the measurement settings. It is also presented in a way to visually represent how the parameters interact to generate the various dynamic result values. Each calibration range has its own set of these parameters and they will be remembered the next time the calibration range is selected again.

| Item | Description | | | | | | | | | | | | | | |
|---------------------------------------|---|--------------|--|--------------|--|---------------|---|---------------|---|----------------|--|-----------------|---|-----------------|---|
| Calibration Range drop-down | <p>Select from the available calibration ranges. Some may have been disabled from the Configuration settings. Note that the handheld will be switched to the selected range as if the user had selected the range using the keypad.</p> <p>Note that selection of this calibration range will select the actual range that the Live Values are referring to and will also set what the System Zero, Zero Masking, Resolution and Scale Steady settings refer to. i.e. these settings are independent for each internal Calibration Range.</p> | | | | | | | | | | | | | | |
| Measurement Rate drop-down | <p>Select the desired internal measurement rate. The faster the measurement the better the detection of fast transient min and max values will be. Note that this does not change the speed at which the LCD updates although the display will appear to update slower if 1 second measurement rate is chosen.</p> <table border="0"> <tr> <td>1 SPS</td> <td>A new measurement value is generated every second.</td> </tr> <tr> <td>3 SPS</td> <td>A new measurement value is generated 3 times a second.</td> </tr> <tr> <td>10 SPS</td> <td>A new measurement value is generated 10 times a second.</td> </tr> <tr> <td>50 SPS</td> <td>A new measurement value is generated 50 times a second.</td> </tr> <tr> <td>100 SPS</td> <td>A new measurement value is generated 100 times a second.</td> </tr> <tr> <td>1200 SPS</td> <td>A new measurement value is generated 1200 times a second.</td> </tr> <tr> <td>2400 SPS</td> <td>A new measurement value is generated 2400 times a second.</td> </tr> </table> | 1 SPS | A new measurement value is generated every second. | 3 SPS | A new measurement value is generated 3 times a second. | 10 SPS | A new measurement value is generated 10 times a second. | 50 SPS | A new measurement value is generated 50 times a second. | 100 SPS | A new measurement value is generated 100 times a second. | 1200 SPS | A new measurement value is generated 1200 times a second. | 2400 SPS | A new measurement value is generated 2400 times a second. |
| 1 SPS | A new measurement value is generated every second. | | | | | | | | | | | | | | |
| 3 SPS | A new measurement value is generated 3 times a second. | | | | | | | | | | | | | | |
| 10 SPS | A new measurement value is generated 10 times a second. | | | | | | | | | | | | | | |
| 50 SPS | A new measurement value is generated 50 times a second. | | | | | | | | | | | | | | |
| 100 SPS | A new measurement value is generated 100 times a second. | | | | | | | | | | | | | | |
| 1200 SPS | A new measurement value is generated 1200 times a second. | | | | | | | | | | | | | | |
| 2400 SPS | A new measurement value is generated 2400 times a second. | | | | | | | | | | | | | | |

| Measurement Quality drop-down | <p>This setting determines how much time is spent averaging the input to generate the new values.</p> <p>Lower quality allows the handheld to perform some power saving between generating new values so improving battery life.</p> <table border="1"> <thead> <tr> <th>Mode</th> <th>description</th> </tr> </thead> <tbody> <tr> <td>Low</td> <td>The minimum amount of measurements are averaged to generate the new value at the measurement rate. The handheld will apply maximum power saving between new generated values so offering the best battery life.</td> </tr> <tr> <td>High</td> <td>All measurements are averaged in between generating new values at the measurement rate. There is no power saving applied in this mode.</td> </tr> </tbody> </table> | Mode | description | Low | The minimum amount of measurements are averaged to generate the new value at the measurement rate. The handheld will apply maximum power saving between new generated values so offering the best battery life. | High | All measurements are averaged in between generating new values at the measurement rate. There is no power saving applied in this mode. |
|---|--|------|-------------|------------|---|-------------|--|
| Mode | description | | | | | | |
| Low | The minimum amount of measurements are averaged to generate the new value at the measurement rate. The handheld will apply maximum power saving between new generated values so offering the best battery life. | | | | | | |
| High | All measurements are averaged in between generating new values at the measurement rate. There is no power saving applied in this mode. | | | | | | |
| Input Too Low indicator | <i>The mV/V input is too low for the selected sensitivity for this range.</i> | | | | | | |
| Input Too High indicator | <i>The mV/V input is too high for the selected sensitivity for this range.</i> | | | | | | |
| mV/V live label | <i>Indicates the current mV/V measurement of the bridge sensor.</i> | | | | | | |
| Calibrated Engineering live label | <i>Indicates the initial value after converting mV/V to the calibrated engineering units.</i> | | | | | | |
| System Zero entry field | <i>Shows the current System Zero value. System Zero value is always subtracted from the Calibrated Engineering value which then gives the Gross value and can compensate for fixed installations where a load is already present before the actual item to be weighed is present. For example, this could be a metal tray on a weigh scale. This value can be directly edited or the following two buttons used to change the value.</i> | | | | | | |
| Zero Now button | <i>Set the value of System Zero to the current calibrated engineering to give a zero Gross value.</i> | | | | | | |
| Remove button | <i>Set the current System Zero value back to zero.</i> | | | | | | |
| Gross live label | <i>This is the current Gross value.</i> | | | | | | |
| Minimum Limit entry field | <i>Shows the minimum limit below which the input is deemed under range. The live value will be replaced with a warning message.</i> | | | | | | |
| Value Too Low indicator | <i>The input value is below the Minimum Limit.</i> | | | | | | |
| Maximum Limit entry field | <i>Shows the maximum limit above which the input is deemed over range. The live value will be replaced with a warning message.</i> | | | | | | |
| Value Too High indicator | <i>The input value is above the Maximum Limit.</i> | | | | | | |
| Gross Min live label | <i>Shows the minimum value the Gross has reached since last reset.</i> | | | | | | |
| Gross Max live label | <i>Shows the maximum value the Gross has reached since last reset.</i> | | | | | | |
| Gross Delta live label | <i>Shows the difference between the minimum and maximum value the Gross has reached since last reset.</i> | | | | | | |
| Scale Steady Band edit field | <i>Enter the band within the display reading must remain (In this range's calibrated units of measure), for the duration specified below, before the Scale Steady flag becomes active.</i> | | | | | | |

| | |
|--|---|
| Scale Steady Duration edit field | The duration in seconds for the above Scale Steady calculation. |
| Tare edit field | <i>The current value of the Tare. This is subtracted from the Gross to give Net.</i> |
| Tare Now button | Use the current Gross value to set the value of Tare to give a zero Net value. |
| Remove Button | Set Tare value back to zero. |
| Net live label | <i>This is the current Net value.</i> |
| Net Min live label | <i>Shows the minimum value the Net has reached since last reset.</i> |
| Net Max live label | <i>Shows the maximum value the Net has reached since last reset.</i> |
| Net Delta live label | <i>Shows the difference between the minimum and maximum value the Net has reached since last reset.</i> |
| Display Resolution entry field | <i>The current setting for the resolution of the display. The resolution</i> |
| Zero Mask entry field | <i>Enter a value band within which the display will show zero.</i> |
| Reset Statistics button | Reset the Net Delta, Gross Min, Gross Max, Net Min and Net Max values. |
| Simulated Display | |
| Display Value live label | Simulated display value showing the effects of the Zero Masking and Resolution settings. |



If a TEDS device is connected then this page will reflect the settings particular to that device.

Calibration

The calibration page shows a summary of all six calibration ranges and, if allowed from the Configuration section, the ranges can be calibrated using a choice of calibration types.

Summary Tab

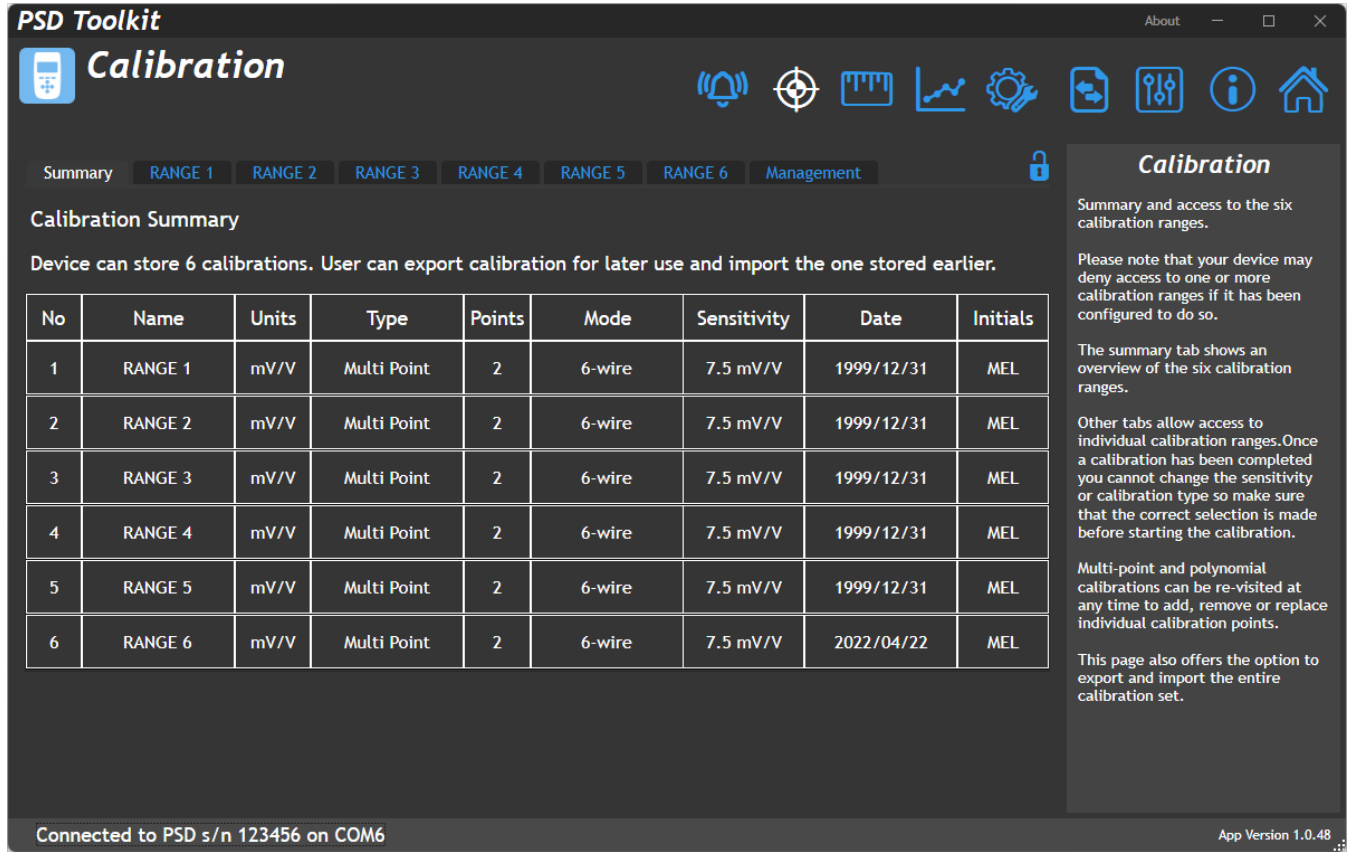

The summary tab allows you to view a summary of how each range has been calibrated.

| Item | Description |
|----------------------|---|
| No header | This simply indicates which calibration range the row of data applies to. |
| Name header | Shows the name assigned to this calibration range. |
| Units header | Shows the engineering units that this calibration range has been calibrated in. |
| Type header | Shows the type of calibration that has been performed on this range. Options are: Gain & Offset Calibration with a single gain and offset. Multi Point Multi point calibration using multiple gain and offset segments. Polynomial Multi point calibration using polynomials. |
| Points header | Displays the number of points that the calibration consists of. |
| Mode header | Indicates the wiring mode expected by this calibration. 4-wire Calibration expects a 4 wire measurement. 6-wire Calibration expects a 6 wire measurement. |

| | |
|------------------------------|---|
| Sensitivity header | Indicates the sensitivity range selected for this range. ±7.5 mV/V ±15 mV/V ±30 mV/V ±60 mV/V ±120 mV/V ±240 mV/V ±480 mV/V |
| Date header | The date when the calibration was performed. |
| Initials header | The initials entered at the time of calibration. |

Range 1 – 6 Tabs

A tab exists for each of the six calibration ranges. Click on a tab to view, edit or start a calibration.

The common controls will be described here but view the individual sections for specifics regarding each calibration type.



It is important to select Sensitivity before starting a calibration. If sensitivity is changed after calibration this may result in incorrect measurement.

| Item | Description |
|---------------------------------|--|
| Name edit field | Shows the name assigned to this calibration range. Click to enter a new name. |
| Mode label | Indicates the type of calibration used internally. By default, the calibration modes are calibrated for 6 wire connections to eliminate the effect of cable length on the calibration. See connection section of the manual where it explains how to wire up for a 4 wire connection to the strain bridge sensor. |
| Sensitivity Drop down | Choose a sensitivity range suitable for the connected strain gauge. Choose the lowest range that exceeds the sensitivity of the connected bridge: <ul style="list-style-type: none"> ±7.5 mV/V ±15 mV/V ±30 mV/V ±60 mV/V ±120 mV/V ±240 mV/V ±480 mV/V |

| | |
|-----------------------------------|---|
| Units drop down | Select the engineering units that this calibration range will be calibrated in. Depending on the chosen units here, this will limit the available conversion units to those compatible with the selected units. |
| Type drop down | Select the type of calibration to perform. Options are: <ul style="list-style-type: none"> Gain & Offset Calibration with a single gain and offset. Multi Point Multi point calibration using multiple gain and offset segments. Polynomial Multi point calibration using polynomials. |
| Points buttons | Add or remove a new calibration point. Calibration points can only be added one at a time. (Not present on the Gain & Offset calibration type. <div style="border: 1px solid blue; padding: 10px; margin-top: 10px;"> <p> <i>NOTE: The advanced re-entrant calibration functionality allows you to add calibration points in any order. You can even come back to the calibration later to add more points or remove them. For example, you may perform various points in compression then the next day return to add more points in tension.</i></p> </div> |
| Initials header | Enter calibrator initials. |
| Live Input label | Indicates the live value of the mV/V input. |
| Live Output label | Shows the live value of the output using the current calibration settings. |
| Calibration Curve chart | This is a coarse view of the calibration points that may help to spot erroneous calibration points. |
| Undo button | Allows the last performed step to be undone. |
| Import button | Import a previously exported calibration data file. |
| Export button | Export the current calibration to a file for later import into the same or a different handheld. |

Calibration Types

Depending on the calibration type chosen, the process of actual calibration will differ. See the sections below.

Gain and Offset

This calibration type consists of a single gain and offset applies to all input values. It consists of one calibration point.

The screenshot shows the 'Calibration' tab in the PSD Toolkit. The 'Name' field is set to 'RANGE 1'. The 'Mode' is '6-wire', 'Sensitivity' is '7.8 mV/V', and 'Type' is 'Gain & Offset'. A 'Calibration Curve' graph shows a linear relationship between 'Input mV/V' and 'Y axis title'. The 'Live Input' is -7.833965 mV/V and the 'Live Output' is -7.833965. A table below shows the calibration point details:

| No | Offset | Gain |
|----|--------|------|
| 1 | 0 | 1 |

The interface also includes a 'Calibration Date' of 1999/12/31 and buttons for 'Undo', 'Import', and 'Export'. The status bar at the bottom indicates 'Connected to PSD s/n 123456 on COM3' and 'App Version 1.0.56'.

Click into the field in the table on the right to set the **Offset** and **Gain**.

| Item | Description |
|--------------------------|---|
| No header | This simply indicates which calibration point the row refers to. In this case there is only ever one point. |
| Offset edit field | Click and enter the required offset value. |
| Gain edit field | Click and enter the required gain value. |

Multi-Point

Multi point calibration allows linearization of up to 11 points. Note that you must use the Points [+] button to add one point at a time. Once the input and output values have been set the button will be enabled to allow another point to be added.

If you know what output is expected for known given input values, then these can simply be entered directly into the table for each point.

Alternatively, you can apply input, click the Acquire button and hit enter once the values in the row are complete.

At a later date you can revisit this type of calibration and expand the number of points to continue applying further calibration points. This is useful, for example, if you calibrated 5 compression points on one day then returned to complete 5 further tension points on another day.

Points can be added in **any** order of input level.

Click into the field in the table on the right to set the **Input** and **Output** values.

| Item | Description |
|--------------------------|---|
| No header | This simply indicates which calibration point the row refers to. |
| Input edit field | If you know the input that gives a known output, then click and enter the value here. Alternatively click the Acquire button to automatically enter this value. |
| Acquire button | Click to automatically apply the current input value. i.e. apply 10kg and enter 10 in the Output field then click Acquire to automatically enter the current input value. |
| Output edit field | Click and enter the required output value for the given input value. |

Polynomial

This type of calibration consists of a list of values used to perform polynomial linearization.

PSD Toolkit Calibration

Summary RANGE 1 RANGE 2 RANGE 3 RANGE 4 RANGE 5 RANGE 6 Management

Name: RANGE 1
Mode: 6-wire
Sensitivity: 7.8 mV/V
Units: mV/V - milliVolts/Volt (Voltage Re)
Type: Polynomial Points: 2
User Initials: MEL

Live Input: -7.833965 mV/V
Live Output: -7.833965

| No | Value |
|----------------|-------|
| x ⁰ | 0 |
| x ¹ | 1 |

Calibration Date: 1999/12/31
Connected to PSD s/n 123456 on COM3
App Version 1.0.56

Polynomial calibration allows linearization of up to 11 points. Note that you must use the Points [+] button to add one point at a time. Once the polynomial value has been entered the button will be enabled to allow another point to be added.



This toolkit does not calculate the polynomial values! It is assumed that the user is already in possession of appropriate polynomial values to enter.

| Item | Description |
|------------------|--|
| No header | This simply indicates which calibration point the row refers to. |
| Value edit field | Enter the polynomial value for this point. |

Management Tab

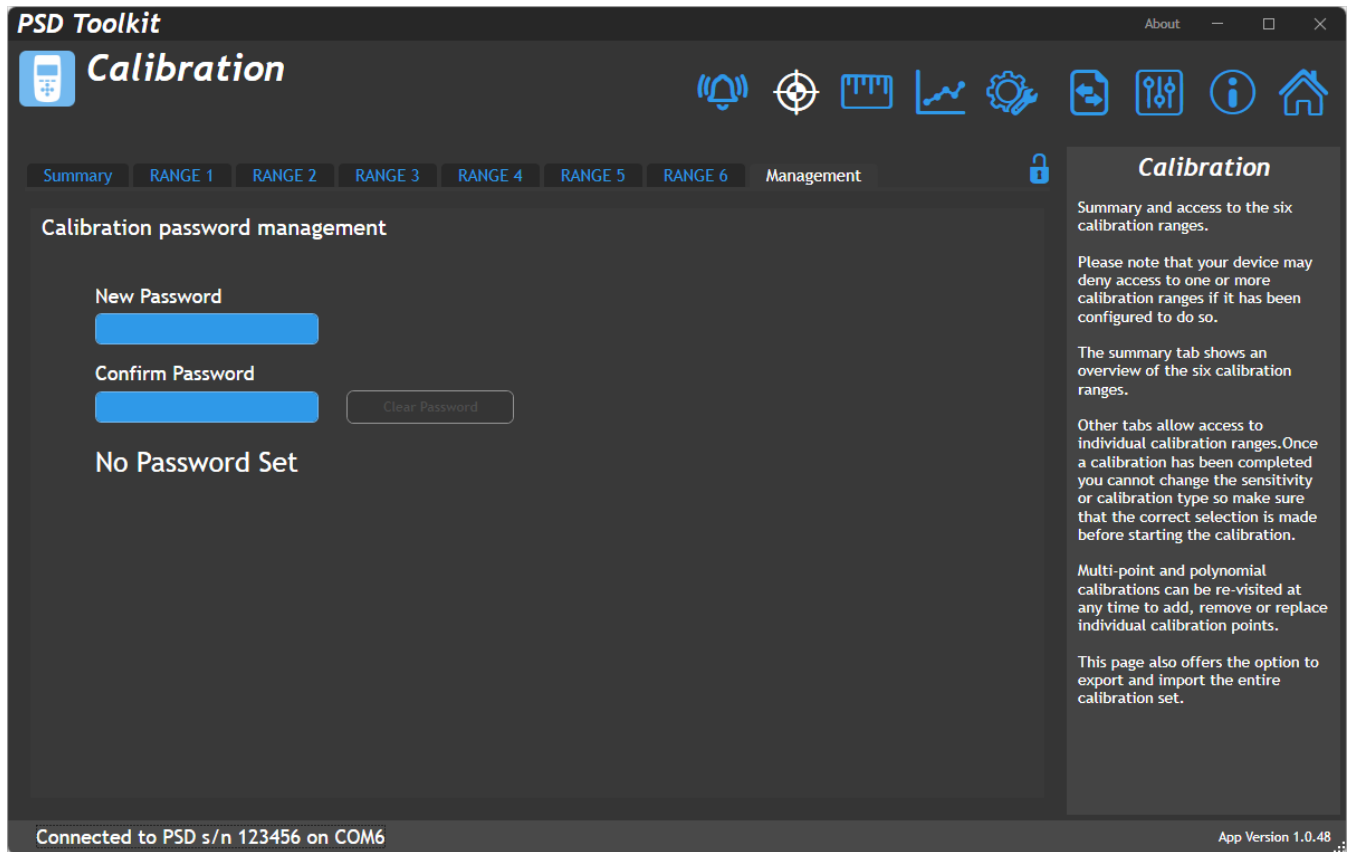

Allows setting a new password or removing an existing password to protect or release the calibration settings.

| Item | Description |
|--------------------------------|---|
| New Password button | Allows a new password to be set to protect the calibration settings of the device. This field will be available whether a password exists or not. |
| Confirm Password button | The new password must be entered in this field as well as the previous field. |
| Set Password button | Click to set the password. |
| Clear Password button | If a password exists, click this button to remove it and to remove protection of the configuration settings. |



A forgotten password **cannot** be recovered and the handheld may need to be returned to the supplier.

DO NOT FORGET YOUR PASSWORD!

Alarm

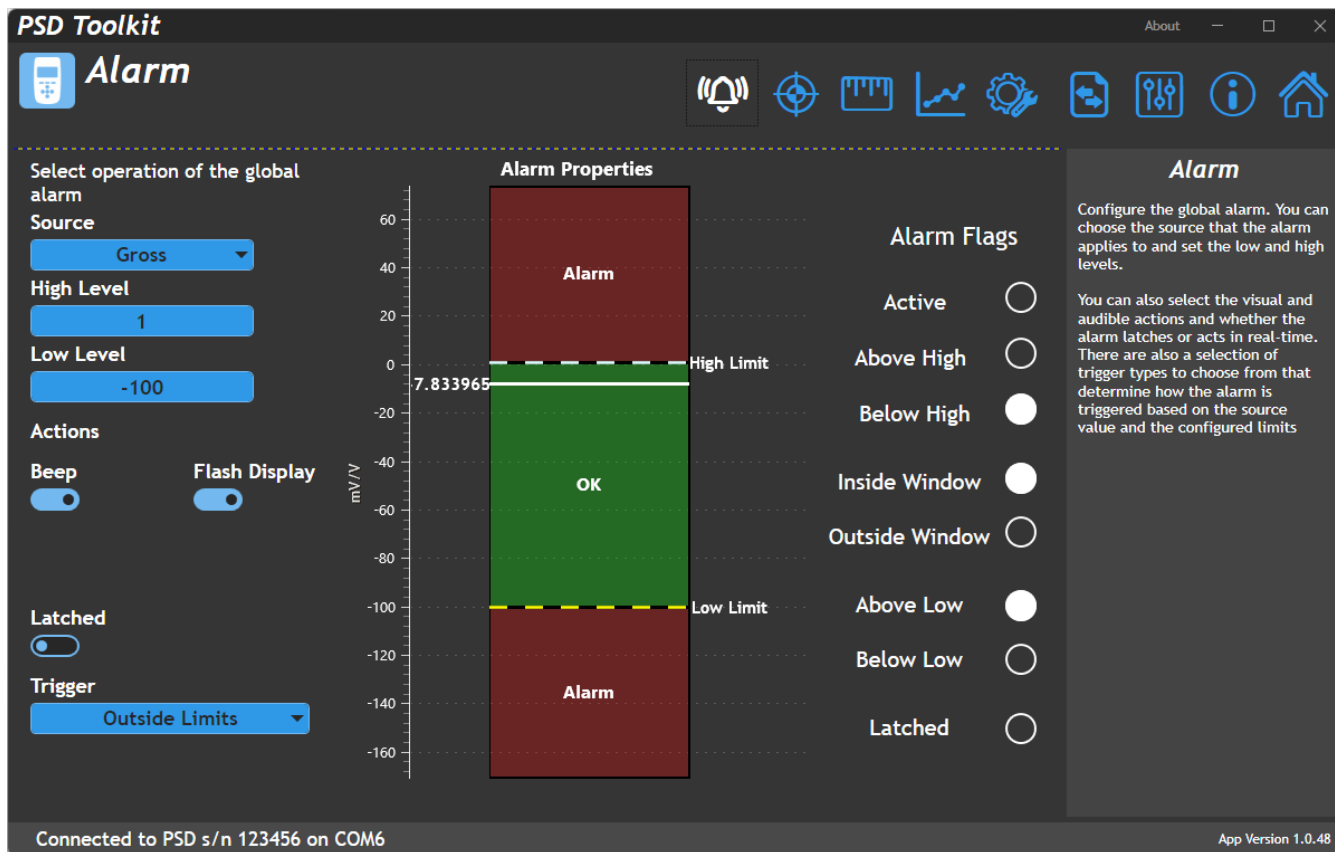

The single, global alarm acts on the currently selected calibration range (or TEDS device) and is solely based on the Source selected here.

| Item | Description |
|---------------------------------|---|
| Source drop-down | Select the required mode for the backlight to operate in. Choices are: Gross Base alarm on the Gross value. Net Base alarm on the Net value. |
| High Level edit field | Enter the value for the higher level alarm point. |
| Low Level edit field | Enter the value for the lower level alarm point. |
| Actions | |
| Beep switch | Select on or off to determine whether the beeper sounds when the alarm is active. |
| Flash Display switch | Select on or off to determine whether the main display flashes when the alarm is active. |
| Latched switch | Select whether the alarm is only active while the source value is outside of the selected trigger criteria. This is Unlatched operation. Latched operation means that the alarm stays active even when the source value is within limits again and requires a manual reset (Via menu) to deactivate. |

| | |
|----------------------------------|---|
| Trigger drop-down | <p>Select how the alarm responds to the source value relative to the two limits.</p> <p>Disabled The alarm remains off</p> <p>Outside Limits The alarm is active when the source value is above the high level OR below the low level</p> <p>Inside Limits The alarm is active when the source value is below the high level AND above the low level</p> <p>Above High The alarm is active when the source value is above the high level</p> <p>Below High The alarm is active when the source value is below the high level</p> <p>Above Low The alarm is active when the source value is above the low level</p> <p>Below Low The alarm is active when the source value is below the low level</p> |
| Alarm Properties Image | <p>This indicates at what input level the alarm will become active. If the input value (Shown) falls within a red zone then the alarm will activate. If it falls within a green zone the alarm will not activate.</p> <p>This action is changed by selecting a different Trigger above.</p> |
| Alarm Flags Indicators | <p>This indicates which of the eight alarm flags are currently active.</p> |

Enclosure

The enclosure is made from ABS with a soft polymer over mold for grip and shock absorption. The enclosure, window and keypad should be wiped down with a damp cloth and a mild detergent (such as dishwashing liquid) or isopropyl alcohol. It is weatherproof and can be washed with a damp cloth. Ensure that the battery compartment is tightly closed.



Avoid using abrasive cleaners. Avoid using anything containing acetone or cellulose.

Dimensions

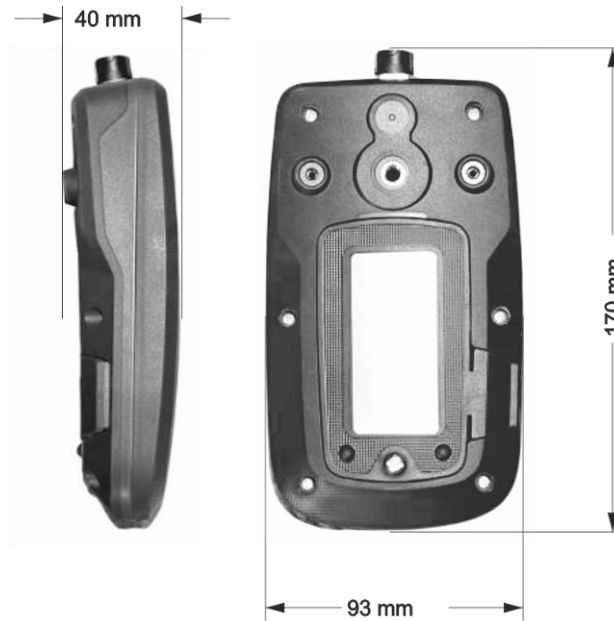

The mating connector will add another 45mm to the height not including any cable. Weight with no mating connector is 350 g.

Battery Compartment

Before re-attaching the battery compartment cover check the rubber seals and grooves for any debris that may compromise the enclosure's water resistance.



The battery compartment cover should remain with the handheld case it was shipped with.

USB Connection

The micro USB socket is waterproof but the rubber dust cover is not intended to be. Before using the USB port please check for and remove any water, sand or other debris. It is safe to rinse the USB socket under a gently running tap.

Be careful when using a USB cable connected with the handheld resting flat on a surface as too much force on the enclosure could damage the USB socket.

Accessories

A ¼" deep threaded socket on the rear of the enclosure allows a range of standard camera fittings to be used to mount the handheld.



Sometimes the handhelds are used fixed in place and the following two accessories offer a choice in mounting.

Magnetic Pad

A 66mm diameter rubber coated magnetic pad that can be screwed onto the back of the enclosure provides for a very strong semi-permanent attachment to metallic surfaces and works equally well on a vertical surface. This is ideal for placing next to machinery in fixed installations.



An optional included ball-joint connection can be used for more positioning options.



Order Code: **ACC-MT-A**

Fixed Mount

This mount is for more permanent fixing for dashboards, desktops and walls. Multiple fixing hole positions secure the base to the surface and a dual ball-jointed arm connects to the handheld enclosure threaded socket. This allows a wide range of positions to be achieved before tightening the arm to fix in place.

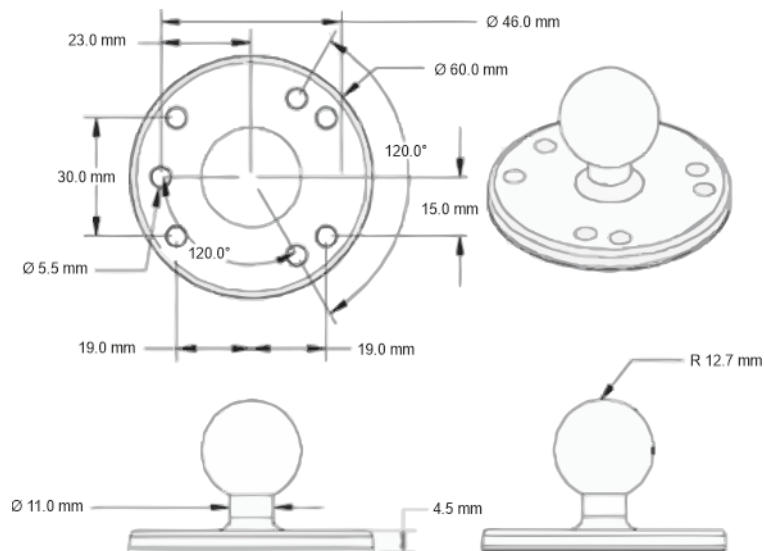

Order Code: **ACC-MT-B**

Carry Case

The carry case allows full access to the handheld display, keypad and connectors while offering a shoulder strap for easy carry and protection from mud and dust.



Order Code: **ACC-CC-A**

USB Cable

Although you can plug any micro USB cable into the PSD for communications and configuration a right angled connector puts less mechanical strain on the connector and socket. The correctly orientated right angle USB cables are available as an accessory.



Order Code: **ACC-CB-A**

Connector Conversion Cable

This cable allows the original PSD connector to be plugged in to the new PSDS using a conversion cable. The cable length is 300mm.



Order Code: **ACC-CB-B**

Specification

Strain Gauge Measurement

| Parameter | Min | Typ | Max | Units | Note |
|-------------------------------------|--------|----------------|--------|--------------|--------------------------------|
| Measurement Method | 6 Wire | | | | Can accept a 4 wire input. |
| Excitation Voltage | 3.2 | 3.3 | 3.4 | VDC | |
| Drive Capability | 85 | - | 10,000 | Ohm | |
| Sensitivity FSR Ranges ¹ | ±7.5 | - | ±480 | mV/V | |
| Linearity ² | | ±2 | | ppm/FSR | In high quality operating mode |
| Offset Temperature Stability | | 12 | | nV/°C | at 2.5mV/V |
| Gain Temperature Stability | | 1 | 2 | ppm/°C | |
| Internal Resolution | | 24 | | bit | |
| Resolution at 1 SPS | | 1,100,000 (20) | | Counts (bit) | Noise free at ±7.5mV/V range |
| Resolution at 10 SPS | | 550,000 (19) | | Counts (bit) | |
| Resolution at 2400 SPS | | 6,500 (14.3) | | Counts (bit) | |
| Filters | | | | | |

1 - Effective sensitivity from ±0.5mV/V with reduced resolution

2 - Linearity error can be further reduced by device linearization calibration

3 - Using Energizer L91 3000mAh cells

Electrical, Mechanical & Environmental

| Parameter | Min | Typ | Max | Units | Note |
|----------------------------------|--|-----|-----|--------|---------------------------|
| Display Resolution | 128 x 64 | | | pixels | |
| Buzzer Acoustic Output | | 45 | | dB | |
| Power Supply ³ | 2x AA (LRx) or USB powered | | | | |
| Power Consumption | | 35 | | mA | Measurement operation |
| Standby Current | | 75 | | uA | |
| Battery Life Low Quality 1Hz | | 220 | | Hrs | |
| Battery Life High Quality 1200Hz | | 60 | | Hrs | |
| Operating Temperature Range | -10 | | 50 | °C | |
| Storage Temperature Range | -20 | | 80 | °C | |
| Operating Humidity Range | 0 | | 95 | %RH | |
| Environmental Protection | IP64 (With connector mated or unmated) | | | | |
| External Dimensions | L: 170mm, W: 94mm, H: 42mm | | | | Excluding mated connector |
| Weight | 365 | | | g | Including batteries |

Units of Measure

The PSD has a large internal table of engineering units allowing conversion from the calibrated units into various other units, within the same measurement category, as required.

In addition to these automatic conversions there are also user defined units which allow the defining of units not contained in this table.

| Category | Unit | Symbol |
|----------------------|-------------------|--------|
| Voltage Ratio | | |
| | mV/V | mV/V |
| | V/V | V/V |
| | µV/V | µV/V |
| Angle | | |
| | radians | rad |
| | degrees | ° |
| | circumference | c |
| | grade | grade |
| | minutes | ' |
| | seconds | " |
| | revolutions | rev |
| Length | | |
| | meters | m |
| | angstrom | Å |
| | astronomical unit | AU |
| | centimeters | cm |
| | chains gunters | ch |
| | ell | ell |
| | em | em |
| | fathoms | fm |
| | feet | ft |
| | furlongs | fur |
| | inches | in |
| | kilometers | km |
| | league | lea |
| | leagues | league |
| | light years | ly |
| | lines | ln |
| | microns | µ |
| | miles nautical | mi n |
| | miles | mi |
| | millimeters | mm |
| | mils | mil |
| | nanometers | nm |
| | parsec | pc |

| | | |
|-----------------|-------------------------------------|--------------------|
| | yards | yd |
| Mass | | |
| | kilograms | kg |
| | drams | dram |
| | grains | grains |
| | grams | g |
| | milligrams | mg |
| | ounces | oz |
| | pennyweights | pwt |
| | pounds | lb |
| | kilopounds | klb |
| | scruples | scruple |
| | slug | slug |
| | tons long | ton |
| | tons metric | T |
| | tonnes | tonne |
| | tons short | sh tn |
| | newtons | N |
| | kilonewtons | kN |
| | decanewton | daN |
| Force | | |
| | newtons | N |
| | decanewton | daN |
| | kilonewtons | kN |
| | millinewtons | mN |
| | meganewtons | MN |
| | crinals | crinal |
| | dynes | dyne |
| | grams force | gf |
| | joules per cm | J/cm |
| | kilograms force | kgf |
| | kilograms force kp | kp |
| | kilograms meter/second ² | Kg ms ² |
| | ounces force | ozf |
| | pounds force | lbf |
| | poundals | pdl |
| | tons force long | tonfl |
| | tons force short | tonfs |
| | tons force metric | tonfm |
| | kilo pounds force | klbf |
| Pressure | | |
| | bar | bar |
| | atmosphere techn | at |

| | | |
|----------------------------|----------------------------|--------------------|
| | atmosphere phys | atm |
| | dyne/cm ² | dyncm ² |
| | foot of water (39°F) | ftH2O |
| | inch of water (39°F) | inH2O |
| | gigapascal | GP |
| | hectopascal | hP |
| | kg force / cm ² | kgfcm ² |
| | kg force / m ² | kgf/m ² |
| | microbar | μbar |
| | pascal | P |
| | newton/m ² | N/m ² |
| | ounce(avdp)/square inch | oz/in ² |
| | pounds per square foot | lb/ft ² |
| | pounds per square inch | psi |
| | tonne per square cm | T/cm ² |
| | meters of water | mH2O |
| | millibar | mbar |
| Speed | | |
| | meter/sec | m/s |
| | centimeters/sec | cm/s |
| | feet/min | ft/min |
| | feet/sec | ft/s |
| | kilometers/hr | km/h |
| | kilometers/min | km/m |
| | kilometers/sec | km/s |
| | knots | kn |
| | meters/hr | m/h |
| | meters/min | m/min |
| | miles/hr | mph |
| | miles/min | mpm |
| | miles/sec | mps |
| | nautical miles/hr | n mph |
| | nautical miles/min | n mpm |
| | nautical miles/sec | n mps |
| Angular Velocity | | |
| | radians/sec | rad/s |
| | degrees/sec | °/s |
| | rpm | rpm |
| Torsional Stiffness | | |
| | newton meter per radian | Nm/rad |
| Torque | | |
| | meter kilogram | m kg |
| | foot pound | ft lb |

| | | |
|---------------------|--------------------|--------------|
| | foot poundal | ft pd |
| | inch pound | in lb |
| | ounce inch | oz-in |
| | milli newton meter | mNm |
| | gram centimeter | g cm |
| RMS Voltages | | |
| | volts rms | V rms |
| | millivolts rms | mV rms |
| | microvolts rms | μ V rms |
| | nanovolts rms | nV rms |
| | kilovolts rms | kV rms |
| Voltages | | |
| | volts | V |
| | millivolts | mV |
| | microvolts | μ V |
| | nanovolts | nV |
| | kilovolts | kV |
| RMS Current | | |
| | amps rms | A rms |
| | milliamps rms | mA rms |
| | microamps rms | μ A rms |
| | nanoamps rms | nA rms |
| | kiloamps rms | kA rms |
| Current | | |
| | amps | A |
| | milliamps | mA |
| | microamps | μ A |
| | nanoamps | nA |
| | kiloamps | kA |
| RMS Power | | |
| | watts rms | W rms |
| | milliwatts rms | mW rms |
| | microwatts rms | μ W rms |
| | kilowatts rms | kW rms |
| Power | | |
| | watts | W |
| | milliwatts | mW |
| | microwatts | μ W |
| | kilowatts | kW |
| | horsepower | hp |
| Temperature | | |
| | celcius | $^{\circ}$ C |
| | farenheight | $^{\circ}$ F |

| | | |
|---------------------------|--------------------------------|------------------------------------|
| | kelvin | K |
| Counts | | |
| | counts | counts |
| Strain | | |
| | strain | ϵ |
| | microstrain | $\mu\epsilon$ |
| Percent | | |
| | percent | % |
| Humidity | | |
| | humidity | %RH |
| Frequency | | |
| | hertz | Hz |
| | kilohertz | kHz |
| | megahertz | MHz |
| | rpm | rpm |
| Resistance | | |
| | ohms | Ω |
| | kilohms | k Ω |
| | megaohms | M Ω |
| Density | | |
| | kilograms per cubic meter | kg/m ³ |
| | grams per litre | g/L |
| | pounds per cubic foot | lb/ft ³ |
| Flow Volume | | |
| | litres per second | L/s |
| | cubic meters per second | m ³ /s |
| | cubic meters per hour | m ³ /h |
| | gallons per minute | g/m |
| | cubic feet per minute | cft/m |
| | litres per minute | L/m |
| Flow | | |
| | kg per second | kg/s |
| | lbs per second | lbs/s |
| Concentration | | |
| | cubic meters per cubic meter | m ³ /m ³ |
| | litres per litre | L/L |
| | cubic foot per cubic foot | ftm ³ /ftm ³ |
| Concentration Mole | | |
| | mole per cubic meter | mol/m ³ |
| | mole per litre | mol/L |
| Acceleration | | |
| | meters per second ² | m/sec ² |

| | | |
|---------------|------------------------------|---------------------|
| | g-force | g |
| | foot per second ² | ft/sec ² |
| Custom | | |
| | custom unit 1 | custom1 |
| | custom unit 2 | custom2 |
| | custom unit 3 | custom3 |
| | custom unit 4 | custom4 |
| | Undefined | |

EU Declaration of Conformity

EU DECLARATION OF CONFORMITY

We, the undersigned:



Name of Manufacturer:

Mantracourt Electronics Ltd

Address:

**The Drive, Farringdon, Exeter, Devon,
EX5 2JB**

Country:

United Kingdom

Declare under our sole responsibility that the **PSDS and PSDA Product Range** is in conformity with the following relevant Union harmonisation legislation:

EMC Directive 2014/30/EU

RoHS Directive 2011/65/EU

LVD Directive 2014/35/EU

Based on the following harmonised standards:

BS EN IEC 61326-1:2021

BS EN IEC 61326-2-3:2021

BS EN 61010-1:2010+A1:2019

/ IEC 61010-1:2010

Name and position of person binding the manufacturer or authorised representative:

Signed

Name:

Robert Willmington-Badcock

Function:

Managing Director

Location:

Mantracourt Electronics Ltd

Date of issue:

18th March 2022



UK Declaration of Conformity

UK DECLARATION OF CONFORMITY

We, the undersigned:



Name of Manufacturer:

Mantracourt Electronics Ltd

Address:

**The Drive, Farringdon, Exeter, Devon,
EX5 2JB**

Country:

United Kingdom

Declare under our sole responsibility that the **PSDS and PSDA Product Range** is in conformity with the relevant UK Statutory Instruments and their amendments:

2016 No 1101

The Electrical Equipment Safety Regulations 2016

2016 No 1091

The Electromagnetic Compatibility Regulations 2016

2012 No 3032

The Restriction of the Use of Hazardous Substances in Electrical and Electronic Equipment Regulations 2012

We hereby declare that the product described above, to which this declaration of conformity refers to, is in conformity with the essential requirements of the following standards:

BS EN IEC 61326-1:2021

BS EN IEC 61326-2-3:2021

BS EN 61010-1:2010+A1:2019

/ IEC 61010-1:2010

Additional Information:

The technical documentation for the machinery is available from:

Name:

Mantracourt Electronics Ltd

Address:

The Drive, Farringdon, Exeter, Devon, EX5 2JB

Signed for & on behalf of:

Mantracourt Electronics Ltd

Place of issue:

Exeter, Devon, EX5 2JB, UK

Date of Issue:

18th March 2022

Name:

Robert Willmington-Badcock

Function:

Managing Director

Signature:



Warranty

All PSDS products from Mantracourt Electronics Ltd., ('Mantracourt') are warranted against defective material and workmanship for a period of one (1) year from the date of dispatch.

If the 'Mantracourt' product you purchase appears to have a defect in material or workmanship or fails during normal use within the period, please contact your Distributor, who will assist you in resolving the problem. If it is necessary to return the product to 'Mantracourt' please include a note stating name, company, address, phone number and a detailed description of the problem. Also, please indicate if it is a warranty repair.

The sender is responsible for shipping charges, freight insurance and proper packaging to prevent breakage in transit.

'Mantracourt' warranty does not apply to defects resulting from action of the buyer such as mishandling, improper interfacing, operation outside of design limits, improper repair or unauthorised modification.

No other warranties are expressed or implied. 'Mantracourt' specifically disclaims any implied warranties of merchantability or fitness for a specific purpose.

The remedies outlined above are the buyer's only remedies. 'Mantracourt' will not be liable for direct, indirect, special, incidental or consequential damages whether based on the contract, tort or other legal theory.

Any corrective maintenance required after the warranty period should be performed by 'Mantracourt' approved personnel only.



Document Title: **PSDS User Manual**
Applies To: **PSDS (Portable Sensor Display)**
Part Number: **517-951**
Issue Number: **01.04**
Dated: **30th June 2023**

In the interests of continued product development, Mantracourt Electronics Limited reserves the right to alter product specifications without prior notice.



www.mantracourt.com